

Versão 3
I26E02N26

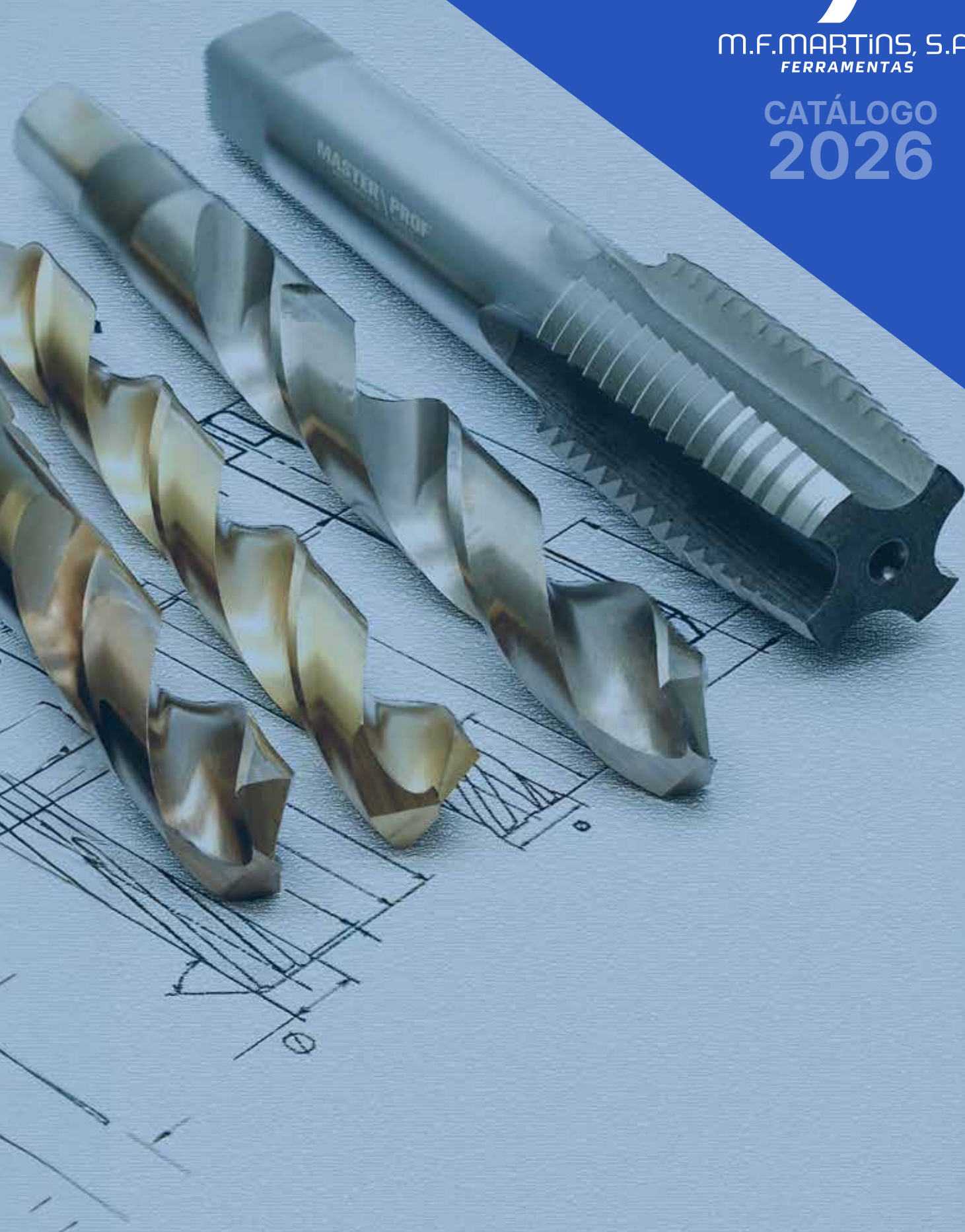

M.F.MARTINS, S.A.
FERRAMENTAS

CATÁLOGO
2026



METAL

CONSTRUÇÃO

MADEIRA

ACESSÓRIOS

ÍNDICE GERAL

GENERAL INDEX
INDICE GÉNÉRAL

FERRAMENTAS PARA METAL

TOOLS FOR METAL
OUTILS POUR LE MÉTAL



22 - 129

FERRAMENTAS PARA CONSTRUÇÃO

TOOLS FOR CONSTRUCTION
OUTILS POUR CONSTRUCTION



132 - 159

FERRAMENTAS PARA MADEIRA

TOOLS FOR WOOD
OUTILS POUR LE BOIS



162 - 167

ACESSÓRIOS

ACCESSORIES
ACCESSOIRES



171 - 210

JK Limas

JK FILES
JK LIMES



214 - 215

WIKUS

TOOLS FOR METAL
OUTILS POUR LE MÉTAL



222 - 252

OUTROS CATÁLOGOS

OTHER CATALOGUES
AUTRES CATALOGUES



253 - 259

INFORMAÇÃO TÉCNICA

TECHNICAL INFORMATION
INFORMATIONS TECHNIQUES



262 - 270

ÍNDICE DE FERRAMENTAS PARA METAL

INDEX FOR METAL TOOLS

INDICE DES OUTILS POUR LE MÉTAL

BROCAS CILÍNDRICAS RETIFICADAS HSS + JOGO

HSS-G STRAIGHT SHANK DRILLS

FORETS CYLINDRIQUES RECTIFIÉS HSS-G

HSS



22/23

MALAS E EXPOSITORES DE BROCAS RETIFICADAS HSS-G

HSS-G STRAIGHT SHANK DRILLS DIN338 - 135° SPLIT-POINT

JEUX, COFFRETS ET PRÉSENTOIRS DE FORETS RECTIFIÉS HSS-G

HSS



24

BROCAS CABO HEXAGONAL INTEGRAL HSS

HSS STRAIGHT SHANK DRILLS HEXAGONAL HANDLE

FORETS CYLINDRIQUES HSS CÂBLE HEXAGONAL

HSS



25

BROCAS CABO HEXAGONAL INTEGRAL HSS-CO 8%

HSS-CO 8% STRAIGHT SHANK DRILLS HEXAGONAL HANDLE

FORETS CYLINDRIQUES HSS-CO CÂBLE HEXAGONAL

HSS-CO



25

BROCAS CILÍNDRICAS RETIFICADAS LONGAS HSS DIN340N - 135° SPLIT-POINT

HSS STRAIGHT SHANK LONG DRILLS DIN340N - 135° SPLIT-POINT

FORETS CYLINDRIQUES SÉRIE LONGUE HSS DIN340N - 135° SPLIT-POINT

HSS



26

BROCAS CILÍNDRICAS RETIFICADAS HSS-CO 8% + JOGO

HSS-CO 8% STRAIGHT SHANK DRILLS DIN338 - 135° SPLIT-POINT

FORETS CYLINDRIQUES RECTIFIÉS HSS-CO 8% DIN338 - 135° - SPLIT-POINT

HSS-CO



27

MALAS E EXPOSITORES DE BROCAS RETIFICADAS HSS-CO 8%

HSS-CO 8% DRILLS SETS, CASES AND DISPLAYS

JEUX, COFFRETS ET PRÉSENTOIRS DE FORETS RECTIFIÉS HSS-CO 8%

HSS-CO



28

BROCAS CILÍNDRICAS RETIFICADAS SPEEDMASTER HSS-G DIN338

HSS-G SPEEDMASTER DRILLS

FORETS CYLINDRIQUES RECTIFIÉS HSS-G DIN338 SPEEDMASTER

HSS



29

BROCAS CILÍNDRICAS RETIFICADAS PONTA ESCALONADA STEP HSS-CO 8%

CYLINDRICAL DRILLS WITH STEPPED TIP STEP HSS-CO

FORETS CYLINDRIQUES RECTIFIÉS À PONTÉ ÉTAGÉE STEP HSS-CO

HSS-CO



30

BROCAS CILÍNDRICAS REBAIXADAS HSS E HSS-CO

HSS AND HSS-CO REDUCED SHANK TWIST DRILLS

FORETS CYLINDRIQUES REDUITE HSS ET HSS-CO

HSS

HSS-CO



31

BROCAS CILÍNDRICAS RETIFICADAS EXTRA CURTA HSS + JOGO

HSS STRAIGHT SHANK STUB DRILLS DIN1897

FORETS CYLINDRIQUES SÉRIE EXTRA COURTE HSS DIN1897

HSS



32

BROCAS COM PONTA EM METAL DURO E METAL DURO INTEGRAL PARA INOX

HSS-CO FOR STAINLESS STEEL AND CARBIDE TIPPED DRILLS

FORETS CYLINDRIQUES HSS-CO POUR ACIER INOXYDABLE ET FORETS CYLINDRIQUES PONTÉ CARBURE

METAL DURO



33

BROCAS HELICOIDAIS CABO CÔNICO HSS DIN345

HSS MORSE TAPER SHANK DRILLS DIN345

FORETS HÉLICOÏDAUX CÂBLE CONIQUE HSS DIN345

HSS



34

JOGO DE BROCAS HELICOIDAIS CABO CÔNICO HSS DIN345

HSS MORSE TAPER SHANK DRILLS SET DIN345

COFFRET FORETS HÉLICOÏDAUX CÂBLE CONIQUE HSS DIN345

HSS



35

ÍNDICE DE FERRAMENTAS PARA METAL

INDEX FOR METAL TOOLS

INDICE DES OUTILS POUR LE MÉTAL

BROCAS DE CENTRAR TIPO A HSS DIN333-A 118°

HSS DOUBLE CENTER DRILLS DIN333-A 118°

FORETS À CENTRER HSS DIN333-A 118°

HSS



36

BROCAS PARA PONTOS DE SOLDADURA HSS-CO, METAL DURO E TIN

HSS-CO AND TIN DRILLS FOR WELDING SPOTS

FORETS POUR POINTS DE SOUDURE HSS-CO ET TIN

HSS-CO

METAL DURO

TIN



36

BROCAS COMBINADAS DE CABO HEXAGONAIS PARA MÁQUINAS PORTÁTEIS HSS-G

HSS-G COMBINED DRILL BITS WITH 1/4" HEXAGON DRIVE

FORETS COMBINÉS CÂBLE HEXAGONAL 1/4" POUR MACHINES PORTABLES HSS-G

HSS



37

BROCAS DE CABO HEXAGONAIS PARA MÁQUINAS PORTÁTEIS HSS-G

HSS-G DRILL BITS WITH 1/4" HEXAGON DRIVE FOR PORTABLE MACHINES

FORETS MÊCHE À 1/4" TIGE HEXAGONALE EN HSS-G POUR MACHINES PORTATIVES

HSS



37

BURIS REDONDOS HSS-CO 10%

CARBIDE K10 ROUND TURNING BLADES

BURINS RONDE EN MÉTAL DUR K10

HSS-CO 10%



38

BURIS QUADRADOS HSS-CO 10%

CARBIDE K10 SQUARE TURNING BLADES

BURINS CARRÉS EN MÉTAL DUR K10

HSS-CO 10%



38

BURIS REDONDOS EM METAL DURO K10

CARBIDE K10 ROUND TURNING BLADES

BURINS RONDE EN MÉTAL DUR K10

METAL DURO K10



39

BURIS RETANGULARES - FORMA D DIN4964 - HSS-CO 10%

CARBIDE K10 RECTANGULAR BLADES

BURINS RECTANGULAIRE EN MÉTAL DUR K10

HSS-CO 10%



39

LÂMINAS FORMA "L1" E "E" EM HSS-CO E SUPORTE PARA LÂMINA SANGRAR

SHAPE "L1" AND "E" TURNING BLADES

LAMES FORME « L1 » ET « E » HSS-CO 10%

HSS-CO



40/41

DISCOS ABRASIVOS DE CORTE E REBARBAR TOP LINE

CUTTING AND GRINDING ABRASIVE DISCS TOP LINE

DISQUES ABRASIFS DE COUPE ET DE MEULAGE TOP LINE



42

DISCOS ABRASIVOS DE CORTE E REBARBAR PREMIUM

CUTTING AND GRINDING ABRASIVE DISCS PREMIUM

DISQUES ABRASIFS DE COUPE ET DE MEULAGE PREMIUM



43

DISCOS ABRASIVOS DE REBARBAR E POLIR PARA INOX

GRINDING AND POLISHING ABRASIVE DISCS FOR STAINLESS STEEL

DISQUES ABRASIFS D'ÉBAUVURAGE ET DE POLISSAGE POUR L'ACIER INOXYDABLE



44

LÂMELAS, FOLHAS, ESFREGÕES E ROLOS

FLAP DISCS, MOP SHEETS AND MOP ROLLERS

LAMELLES, FEUILLES DE MOP ET ROULEAUX DE MOP



45 A 47

NOVO

ESCAREADORES HSS-CO E TITÂNIO

HSS-CO AND TIN COATED COUNTERSINKS

ALÉSIOIRS HSS-CO ET EN TITANE

HSS-CO

TIN



48

ÍNDICE DE FERRAMENTAS PARA METAL

INDEX FOR METAL TOOLS

INDICE DES OUTILS POUR LE MÉTAL

ESCAREADORES 90° TOPLINE HSS-CO E HSS-TIN

HSS-CO AND HSS-TIN 90° TOPLINE COUNTERSINKS

ALÉSOIRS 90° TOPLINE HSS-CO ET HSS-TIN

HSS-CO

TIN



49

JOGOS DE ESCAREADORES 90° TOPLINE HSS-CO E HSS-TIN

HSS-CO AND HSS-TIN 90° TOPLINE COUNTERSINKS SETS

JEUX ALÉSOIRS 90° TOPLINE HSS-CO ET HSS-TIN

HSS-CO

TIN



50

ESCAREADORES DE 90° CABO HEXAGONAL HSS

HSS COUNTERSINKS HEXAGONAL HANDLE

FRAISES CONIQUE HSS POIGNÉE HEXAGONALE

HSS



51

ESCAREADORES ANTIVIBRAÇÃO COM HÉLICE ANTERNADA HSS-CO

ANTIVIBRATION HSS-CO COUNTERSINKS

ALÉSOIRS ANTI-VIBRATION HSS-CO

HSS-CO



51

FRESAS ESCALONADAS HSS E TIN

HSS AND TIN STEP DRILLS

FRAISE-ESCALIERS HSS ET TIN

HSS

TIN



52

FRESAS ESCALONADAS HSS COM CABO HEXAGONAL 1/4 - E6.3 + JOGOS

HSS STEP DRILLS WITH HEXAGONAL CABLE

FRAISE-ESCALIERS AVEC CÂBLE HEXAGONALE HSS

HSS



53

FRESAS FRONTAIS DE 1 NAVALHA P/ ALUMÍNIO SÉRIE CURTA E LONGA HSS

ALUMINIUM 1Z HSS FINISHING END MILLS

FRAISES FRONTALES À 1 COUPEAU POUR ALUMINIUM SÉRIE COURTE ET LONGUE HSS

HSS



54

FRESAS FRONTAIS DE 1 NAV. P/ ALUMÍNIO SÉRIE CURTA/LONGA METAL DURO

ALUMINIUM 1Z HSS FINISHING END MILLS

FRAISES FRONTALES À 1 COUPEAU POUR ALUMINIUM SÉRIE COURTE ET LONGUE MÉTAL DUR

METAL DURO



54

FRESAS FRONTAIS 1 NAV. POLIDAS TIPO ESPELHO P/ ALUMÍNIO EM METAL DURO

1Z MIRROR POLISHED END MILLS

FRAISES FRONTALES 1 NAV. POLI MIROIR POUR L'ALUMINIUM MÉTAL DUR

METAL DURO



55

FRESAS FRONTAIS 2 NAVALHAS CABO CILÍNDRICO HSS-CO 8% E TIALSIN

2Z HSS-CO 8% FINISHING END MILLS

FRAISES FRONTAUX 2 COUPEAUX CÂBLE CYLINDRIQUE HSSE 8% ET TIALSIN

HSS-CO

TIALSIN



56

FRESAS FRONTAIS 3 NAVALHAS CABO CILÍNDRICO HSS-CO 8% E TIALSIN

3Z HSS-CO 8% FINISHING END MILLS

FRAISES FRONTAUX 3 COUPEAUX CÂBLE CYLINDRIQUE HSSE 8% ET TIALSIN

HSS-CO

TIALSIN



57

FRESAS FRONTAIS 4 NAVALHAS CABO CILÍNDRICO HSS-CO 8% E TIALSIN

4Z HSS-CO 8% FINISHING END MILLS

FRAISES FRONTAUX 4 COUPEAUX CÂBLE CYLINDRIQUE HSSE 8% ET TIALSIN

HSS-CO

TIALSIN



58

FRESAS FRONTAIS 4 NAV. CABO CIL. C/ CENTRO DESBASTE HSS-CO E TIALSIN

4Z HSS-CO 8% FINISHING END MILLS

FRAISES FRONTALES 4 COUPEAUX CÂBLE CIL. AVEC CENTRE D'ÉBAUCHE HSSE 8% ET TIALSIN

HSS-CO

TIALSIN



59

FRESAS FRONTAIS 2 NAV. CABO CIL. C/ CENTRO METAL DURO E CROMAX

2Z CARBIDE END MILLS

FRAISES FRONTAUX 2 COUPEAUX CÂBLE CIL. AVEC CENTRE EN MÉTAL DUR ET CHROMAX

METAL DURO

CROMAX



60

ÍNDICE DE FERRAMENTAS PARA METAL

INDEX FOR METAL TOOLS

INDICE DES OUTILS POUR LE MÉTAL

FRESAS FRONTAIS 3 NAV. CABO CIL. C/ CENTRO METAL DURO E CROMAX

3Z CARBIDE END MILLS

FRAISES FRONTAUX 3 COUTEAUX CÂBLE CIL. AVEC CENTRE EN MÉTAL DUR ET CROMAX

METAL DURO
CROMAX



60

FRESAS FRONTAIS 4 NAV. CABO CIL. C/ CENTRO METAL DURO E CROMAX

4Z CARBIDE END MILLS

FRAISES FRONTAUX 4 COUTEAUX CÂBLE CIL. AVEC CENTRE EN MÉTAL DUR ET CROMAX

METAL DURO
CROMAX



61

MÁQUINAS ELETROMAGNÉTICAS

MAGNETIC DRILL

MACHINE À BASE ÉLECTROMAGNÉTIQUE



62

FRESAS PARA MÁQ. ELETROMAGNÉTICA SÉRIES CURTAS/LONGAS M2L

WELDON SHANK HSS CORE DRILLS FOR MAGNETIC MACHINES

FRAISES HSS À CAROTTER AVEC WELDON QUEUE POUR MACHINES À EMBASE ÉLECTROMAGNÉTIQUE

HSS M2L



66

FRESAS PARA MÁQUINAS ELETROMAGNÉTICA SÉRIE CURTA ENCAIXE FEIN

FEIN SHANK HSS CORE DRILLS FOR MAGNETIC MACHINES

FRAISES HSS À CAROTTER FEIN QUEUE POUR MACHINES À EMBASE ÉLECTROMAGNÉTIQUE

HSS



67

FRESAS PARA MÁQ. ELETROMAGNÉTICA SÉRIES CURTAS /LONGAS HSS-CO 8%

WELDON SHANK HSS-CO 8% CORE DRILLS FOR MAGNETIC MACHINES

FRAISES HSS-CO 8% À CAROTTER AVEC WELDON QUEUE POUR MACHINES À EMBASE ÉLECTROMAGNÉTIQUE

HSS-CO



68

FRESAS PARA MÁQ. ELETROMAGNÉTICA SÉRIES CURTAS/LONGAS EM HSS+TIALN

WELDON SHANK TIALN CORE DRILLS FOR MAGNETIC MACHINES

FRAISES TIALN À CAROTTER AVEC WELDON QUEUE POUR MACHINES À EMBASE ÉLECTROMAGNÉTIQUE

HSS

TIALN



69

FRESAS PARA MÁQUINAS ELETROMAGNÉTICAS EM TCT (DENTES METAL DURO)

WELDON SHANK CARBIDE TIP CORE DRILLS FOR MAGNETIC MACHINES

FRAISES À CAROTTER AU CARBURE DE TUNGSTÈNE POUR MACHINES À EMBASE ÉLECTROMAGNÉTIQUE

METAL DURO



70

ADAPTADORES PARA FRESAS ELETROMAGNÉTICAS

CORE DRILLS ACCESSORIES FOR MAGNETIC MACHINES

ACCESSOIRES POUR FRAISES À CAROTTER

HSS



71

EXPULSORES PARA FRESAS ELETROMAGNÉTICAS

CORE DRILLS ACCESSORIES FOR MAGNETIC MACHINES

ACCESSOIRES POUR FRAISES À CAROTTER

HSS



71

PORTA FRESAS

CORE DRILLS ACCESSORIES FOR MAGNETIC MACHINES

ACCESSOIRES POUR FRAISES À CAROTTER

HSS



71

EXPOSITORES E MALAS DE FRESAS P/ MÁQUINAS C/ BASE ELETROMAGNÉTICA

DISPLAYS AND CASES FOR CORE DRILLS

PRÉSENTOIRS ET COFFRETS DE COUPE POUR MACHINES À BASE ÉLECTROMAGNÉTIQUE

HSS M2L



72

FRESAS PERFURADORAS RETIFICADAS E JOGOS EM HSS

HSS HOLE CUTTERS

FRAISES DE PERÇAGE HSS RECTIFIÉES

HSS



73

ÍNDICE DE FERRAMENTAS PARA METAL

INDEX FOR METAL TOOLS

INDICE DES OUTILS POUR LE MÉTAL

FRESAS PERFORADORAS RETIFICADAS E JOGOS EM HSS REVESTIDAS A TIN

TIN COATED HOLE CUTTERS

FRAISES DE PERÇAGE HSS RECTIFIÉES ET REVÊTUES DE TIN

TIN



74

FRESAS PERFORADORAS RETIFICADAS E JOGOS EM HSS REVESTIDAS A TIALN

TIALN COATED HOLE CUTTERS

FRAISES DE PERÇAGE HSS RECTIFIÉES ET REVÊTUES DE TIALN

TIALN



75

FRESAS PERFORADORAS TCT COM DENTES EM METAL DURO (PARA INOX) E JOGOS

WELDED SHANK CARBIDE TIP CORE DRILLS FOR MAGNETIC MACHINES

FRAISES DE PERÇAGE TCT AVEC DENTS EN MÉTAL DUR (POUR L'ACIER INOXYDABLE)

METAL DURO



76

FRESAS ROTATIVAS EM METAL DURO HM-4 E HM-3 (CABO Ø 6MM)

HM-4 AND HM-3 HARD METAL ROTARY MILLS (SHANK Ø 6mm)

FRAISES ROTATIFS EN MÉTAL DUR HM-4 ET HM-3 (CÂBLE Ø 6 mm)

METAL DURO



77

EXPOSITOR E JOGOS DE FRESAS ROTATIVAS EM METAL DURO HM-4 E HM-3

DISPLAY AND SET OF ROTARY CUTTER MILLS HM-4 AND HM-3

PRÉSENTOIR ET JEUX DE FRAISES ROTATIVES EN MÉTAL DUR HM-4 ET HM-3

METAL DURO



78

FRESAS ROTATIVAS EM HSS (CABO Ø 6MM) + JOGO

ROTARY MILLS IN HSS (SHANK Ø 6mm)

FRAISES ROTATIVES HSS (CÂBLE Ø 6mm)

HSS



79

VITRINES DE FRESAS

CUTTERS SHOWCASES

PRÉSENTOIRS FRAISES

HSS

HSS-CO

METAL DURO



80 A 83

JOGOS DE MACHOS MANUAIS ROSCA MÉTRICA E ROSCA MÉTRICA FINA EM HSS

HSS HAND TAPS SETS

JEUX DE TARAUDS À MAIN HSS

HSS



84

JOGOS DE MACHOS MANUAIS ROSCA ESQUERDA HSS E ROSCA BSW HSS

HSS HAND TAPS SETS

JEUX DE TARAUDS À MAIN HSS

HSS



85

JOGOS DE MACHOS MANUAIS ROSCA MÉTRICA HSS-CO VAPO PARA INOX

HSS HAND TAPS SETS

JEUX DE TARAUDS À MAIN HSS, HSS-CO ET TIN

HSS-CO



85

JOGOS DE MACHOS MANUAIS ROSCA MÉTRICA EM TIN PARA INOX

HSS HAND TAPS SETS

JEUX DE TARAUDS À MAIN HSS

TIN



85

JOGOS DE MACHOS MANUAIS ROSCA BSP (GAS) HSS

HSS HAND TAPS SETS

JEUX DE TARAUDS À MAIN HSS

HSS



86

JOGOS DE MACHOS MANUAIS ROSCA UNC HSS

HSS HAND TAPS SETS

JEUX DE TARAUDS À MAIN HSS

HSS



86

JOGOS DE MACHOS MANUAIS ROSCA UNF-SAE HSS

HSS HAND TAPS SETS

JEUX DE TARAUDS POUR MACHINE À FILETAGE BSP (GAZ), UNC ET UNF-SAE EN HSS

HSS



86

ÍNDICE DE FERRAMENTAS PARA METAL

INDEX FOR METAL TOOLS

INDICE DES OUTILS POUR LE MÉTAL

MACHOS MANUAIS ROSCA MÉTRICA HSS E ROSCA BSW / WHITWORTH HSS

HSS METRIC THREAD AND BSW WHITWORTH THREAD HAND TAPS

TARAUDS À MAIN À FILETAGE MÉTRIQUE HSS ET À FILETAGE HSS BSW / WHITWORTH

HSS



87

MACHOS P/ MÁQ. ROSCA MÉTRICA HSS NAVALHA DIREITA/HELICOIDAL

HSS MACHINE TAPS WITH METRIC THREAD DIN371/376

TARAUDS POUR MACHINES À FILETAGE MÉTRIQUES HSS DIN371/376

HSS



88

JOGOS MACHOS P/ MÁQ. ROSCA MÉTRICA HSS

HSS MACHINE TAPS WITH METRIC THREAD DIN371/376

JEUX DE TARAUDS POUR MACHINES À FILETAGE MÉTRIQUES HSS DIN371/376

HSS



88

MACHOS P/ MÁQ. ROSCA MÉTRICA HSS-CO NAVALHA DIREITA/HELICOIDAL

HSS MACHINE TAPS WITH METRIC THREAD DIN371/376

TARAUDS MACHINE MÉTRIQUE HSS DIN371/376

HSS-CO



89

JOGOS MACHOS P/ MÁQ. ROSCA MÉTRICA HSS-CO

HSS-CO MACHINE TAPS WITH METRIC THREAD DIN371/376

JEUX DE TARAUDS MACHINE MÉTRIQUE HSS-CO DIN371/376

HSS-CO



89

MACHOS P/ MÁQ. ROSCA ROSCA BSW HSS-CO E ROSCA MÉTRICA TIN

HSS-CO BSW AND METRIC TIN MACHINE TAPS DIN371/376

TARAUDS POUR MACHINES À FILETAGE MÉTRIQUES BSW HSS-CO ET FILETAGE MÉTRIQUES TIN/

TIN



90

JOGOS MACHOS P/ MÁQ. ROSCA ROSCA BSW HSS-CO E ROSCA MÉTRICA TIN

HSS-CO BSW AND METRIC TIN MACHINE TAPS DIN371/376

JEUX DE TARAUDS POUR MACHINES À FILETAGE MÉTRIQUES BSW HSS-CO ET FILETAGE MÉTRIQUES

TIN



90

MACHOS PARA MÁQUINA ROSCA BSP (GAS) EM HSS-CO

HSS-CO MACHINE TAPS BSP (GAS) THREAD DIN5156

TARAUDS POUR MACHINE À FILETAGE BSP (GAZ) EN HSS-CO DIN5156

HSS-CO



91

MACHOS P/ MÁQ. ROSCA MÉTRICA HSS-CO

HSS-CO BSW AND METRIC TIN MACHINE TAPS DIN371/376

TARAUDS POUR MACHINES À FILETAGE MÉTRIQUES HSS-CO

HSS-CO



92

JOGOS MACHOS P/ MÁQ. ROSCA MÉTRICA HSS-CO

HSS-CO BSW AND METRIC TIN MACHINE TAPS DIN371/376

JEUX DE TARAUDS POUR MACHINES À FILETAGE MÉTRIQUES HSS-CO

HSS-CO



92

MACHOS P/MÁQ TRABALHOS ESPECIAIS P/ INOX EM HSS-CO VAPO

HSS-CO MACHINE TAPS FOR SPECIAL INOX WORK

TARAUDS MACHINE HSS-CO POUR TRAVAUX SPÉCIAUX EN INOX

HSS-CO



93

JOGOS MACHOS P/MÁQ TRABALHOS ESPECIAIS P/ INOX EM HSS-CO VAPO

HSS-CO MACHINE TAPS FOR SPECIAL INOX WORK

JEUX DE TARAUDS MACHINE HSS-CO POUR TRAVAUX SPÉCIAUX EN INOX

HSS-CO



93

MACHOS P/MÁQ P/ TRABALHOS ESPECIAIS P/MATERIAIS DUROS EM HSS-CO

HSS-CO MACHINE TAPS FOR SPECIAL WORK

TARAUDS MACHINE HSS-CO POUR TRAVAUX SPÉCIAUX

HSS-CO



94

JOGOS MACHOS P/MÁQ P/ TRABALHOS ESPECIAIS P/MATERIAIS DUROS EM HSS-CO

HSS-CO MACHINE TAPS FOR SPECIAL WORK

JEUX DE TARAUDS MACHINE HSS-CO POUR TRAVAUX SPÉCIAUX

HSS-CO



94

ÍNDICE DE FERRAMENTAS PARA METAL

INDEX FOR METAL TOOLS

INDICE DES OUTILS POUR LE MÉTAL

MACHOS PARA MÁQUINA PARA TRABALHOS ESPECIAIS EM HSS-CO ROSCA ALTERNADA PARA ALUMÍNIO

HSS-CO MACHINE TAPS FOR SPECIAL WORK
TARAUDS MACHINE HSS-CO POUR TRAVAUX SPÉCIAUX

HSS-CO



95

MACHOS PARA MÁQUINA PARA TRABALHOS ESPECIAIS EM HSS-CO LAMINAÇÃO HSS-CO NITRATO TITÂNIO

HSS-CO MACHINE TAPS FOR SPECIAL WORK
TARAUDS MACHINE HSS-CO POUR TRAVAUX SPÉCIAUX

HSS-CO



95

MACHOS PARA MÁQUINA PARA TRABALHOS ESPECIAIS EM HSS-CO NAVALHAS DIREITAS HSS-CO - TIALN

HSS-CO MACHINE TAPS FOR SPECIAL WORK
TARAUDS MACHINE HSS-CO POUR TRAVAUX SPÉCIAUX

HSS-CO



95

MACHOS P/ MÁQUINA MÉTRICA FINA EM HSS-CO DIN374/B (PASSES ESPECIAIS)

HSS-CO MACHINE TAPS WITH FINE METRIC DIN374/B (SPECIAL THREADS)
TARAUDS POUR MACHINE MÉTRIQUE FINE EN HSS-CO DIN374/B (PASSES SPÉCIALES)

HSS-CO



96

MACHOS PARA TRABALHOS ESPECIAIS BROCA - MACHO HSS-CO (2 EM 1)

MACHINE TAPS FOR SPECIAL WORKS
TARAUDS MACHINE POUR TRAVAUX SPÉCIAUX

HSS-CO



99

MACHOS PARA TRABALHOS ESPECIAIS BROCA - MACHO - ESCAREADOR HSS (3 EM 1)

MACHINE TAPS FOR SPECIAL WORKS
TARAUDS MACHINE POUR TRAVAUX SPÉCIAUX

HSS



99

MACHOS BIT PARA TRABALHOS ESPECIAIS HSS-CO + JOGO / CONTA FIOS

MACHINE TAPS FOR SPECIAL WORKS
TARAUDS MACHINE POUR TRAVAUX SPÉCIAUX

HSS

HSS-CO



99

CABEÇAS DE ROSCAR PARA MACHOS COM RETORNO AUTOMÁTICO E ACESSÓRIOS

REVERSAL TAPPING CHUCKS
TÊTES DE FILETAGE AVEC RETOUR AUTOMATIQUE



100

CAÇONETES

DIES
FILIERES

HSS



101 A 103

CAÇONETES ROSCA MÉTRICA HSS-CO PARA INOX

DIES HSS-CO INOX
FILIERES HSS-CO INOX

HSS-CO INOX



102

DESANDADORES DE MACHOS

TAPS AND DIES HOLDERS / SCREW EXTRACTORS
PORTE-TARAUDS ET PORTE-FILIERES / EXTRACTEUR VIS

ZAMAC

AÇO



104

DESANDADORES DE CAÇONETES

TAPS AND DIES HOLDERS / SCREW EXTRACTORS
PORTE-TARAUDS ET PORTE-FILIERES / EXTRACTEUR VIS

ZAMAC

AÇO



104

DESANDADOR DE MACHOS COM ROQUETE E ROQUETE LONGO

TAPS AND DIES HOLDERS / SCREW EXTRACTORS
PORTE-TARAUDS ET PORTE-FILIERES / EXTRACTEUR VIS



104

EXTRATOR DE PARAFUSOS + JOGO

TAPS AND DIES HOLDERS / SCREW EXTRACTORS
PORTE-TARAUDS ET PORTE-FILIERES / EXTRACTEUR VIS



104

ÍNDICE DE FERRAMENTAS PARA METAL

INDEX FOR METAL TOOLS

INDICE DES OUTILS POUR LE MÉTAL

ESTOJOS DE MACHOS E CAÇONETES HSS-G E HSS-CO

HSS-G AND HSS-CO DRILLS AND DIES CASES

ASSORTIMENTS POUR TARAUDS ET FILIÈRES HSS-G ET HSS-CO

HSS

HSS-CO



105

ESTOJOS DE MACHOS E CAÇONETES BSW HSS-G

THREADING SETS IN METAL OR WOOD CASES

ASSORTIMENTS POUR TARAUDS ET FILIÈRES HSS-G

HSS



106

ESTOJO DE MACHOS E CAÇONETES AUTO ESPECIAIS P/ GARAGEM CROMO VANADIUM

THREADING SET FOR AUTOMOTIVE IN C. V.

ASSORTIMENTS POUR TARAUDS ET FILIÈRES SPÉCIALES POUR LE GARAGE

106



JOGOS DE MACHOS DE MÁQUINA, ESCAREADORES E CAÇONETES EM HSS

PROFESSIONAL KIT FOR DRILLING, DEBURRING AND THREADING

KIT PROFESSIONNEL POUR LE PERÇAGE, L'ÉBAVURAGE ET LE FILETAGE

HSS

107



JOGOS PARA REPARAR ROSCAS K-COIL/ MACHO K-COIL FORMA D

K-COIL THREAD REPAIR SETS

JEUX DE RÉPARATION DE FILETS K-COIL

HSS

108 A 111



ACESSÓRIOS K-COIL

K-COIL ACCESSORIES

ACCESSOIRES POUR RÉTABLIR TARAUDAGES ENDOMMAGÉES

HSS

112



INSERTO ROSCADO K-COIL

K-COIL THREAD INSERT

RESSORTS FILETÉS EN ACIER INOXIDABLE

HSS

113/114



INSERTOS AUTO ROSCANTES + JOGO E FERRAMENTAS PARA INSERTOS

MASTERFIX CASES

JEUX MASTERFIX

Aço Temperado

115/116

NOVO



SERRAS CIRCULARES PARA METAIS NÃO FERROSOS HSS, HSS-CO E TIN

CIRCULAR SAWS FOR NON-FERROUS METALS

SCIES CIRCULAIRES POUR ACIERS SPÉCIAUX

HSS

HSS-CO

TIN

117



SERRAS CIRCULARES PARA AÇOS ESPECIAIS EM TIALN E TICN

CIRCULAR SAWS FOR SPECIAL STEEL

SCIES CIRCULAIRES POUR ACIERS SPÉCIAUX

TIALN

TICN

118



SERRAS CIRCULARES PARA CORTE DE METAIS, FORMA A - DIN1837 HSS

CIRCULAR SAWS FOR METAL CUTTING, SHAPE A - DIN1837 HSS

SCIES CIRCULAIRES POUR LA COUPE DES MÉTAUX, FORME A - DIN1837 HSS

HSS

119



SERRAS CIRCULARES DE SEGMENTOS EM HSS

HSS SEGMENT CIRCULAR SAWS

SCIES CIRCULAIRES À SEGMENTS HSS

HSS

121



SERRAS DE PASTILHA COM DENTES EM METAL DURO

CARBIDE TIPPED CIRCULAR SAW BLADES

SCIES À PLAQUETTES AVEC DENTS EN MÉTAL DUR

METAL DURO

122 A 123



SERRAS DE FITA PARA A INDÚSTRIA ALIMENTAR EM AÇO CARBONO E INOX

CARBON STEEL AND INOX BAND SAW BLADES FOR THE FOOD INDUSTRY

SCIES À RUBAN POUR L'INDUSTRIE ALIMENTAIRE

HSS-CO INOX

124



ÍNDICE DE FERRAMENTAS PARA METAL

INDEX FOR METAL TOOLS

INDICE DES OUTILS POUR LE MÉTAL

SERRAS DE FITA BIMETÁLICA M42

M42 BIMETALLIC BAND SAW BLADES
SCIES À RUBAN BIMÉTALLIQUES M42

HSS-CO



125/126

MASTER-OIL MULTIUSOS, EXTRA, -OIL CUT, MICRO-PULVERIZAÇÃO, CUT ALUMÍNIO

MASTER-OIL MULTI USES, MASTER-OIL EXTRA, MASTER-OIL CUT
HUILES POLYVALENT, EXTRA ET COUPE



128/129

MASTER-OIL SPRAY ÓLEO DE CORTE

MASTER-OIL CUT SPRAY
HUILES MICRO-PULVÉRISATION, COUPE ALUMINIUM ET HUILE DE COUPE EN SPRAY



129

ÍNDICE DE FERRAMENTAS PARA CONSTRUÇÃO

INDEX FOR CONSTRUCTION TOOLS

INDICE DES OUTILS DE CONSTRUCTION

BROCAS PARA MARTELOS SDS/PLUS "S4" SUPER PROFISSIONAL + JOGO

SDS PLUS ROTARY HAMMER DRILLS
FORETS PERCUSSION SDS-PLUS "S4"



132

BROCAS PARA MARTELOS SDS/PLUS "4X4" SUPER PROFISSIONAL + JOGO

4 CUTTERS SDS/PLUS ROTARY HAMMER DRILLS
FORETS PERCUSSION SDS-PLUS 4X4



133

BROCAS PARA MARTELOS SDS MAX - 4 CORTES (PREMIUM)

4 CUTTERS SDS MAX ROTARY HAMMER DRILLS (PREMIUM)
FORETS PERCUSSION SDS-MAX 4 POINTES (PREMIUM)



134

BROCAS CILÍNDRICAS PARA PEDRA "STANDARD" CURTA E LONGA + JOGO

STANDARD MASONRY CARBIDE TIPPED DRILLS (HIGH QUALITY)
FORETS POINTE CARBURE MAÇONNERIE "STANDARD" (QUALITÉ SUPPLÉMENTAIRE)



135

BROCAS UNIVERSAIS "FURA TUDO" + JOGO

UNIVERSAL "MULTI-PURPOSE" DRILLS
FORETS UNIVERSELS "POLYVALENTE"



136

BROCAS UNIVERSAIS "FURA TUDO" DE ALTO RENDIMENTO + JOGOS

HIGH PERFORMANCE UNIVERSAL "MULTI-PURPOSE" DRILLS
FORETS UNIVERSELS "POLYVALENTE" - HAUTE PERFORMANCE



137

BROCAS UNIVERSAIS "FURA TUDO" ALTO RENDIMENTO CABO HEX 1/4 + JOGO

HIGH PERFORMANCE UNIVERSAL "MULTI-PURPOSE" DRILLS WITH HEXAGONAL HANDLE
FORETS UNIVERSELS "POLYVALENTE" POIGNÉE HEXAGONALE- HAUTE PERFORMANCE



138

BROCA ESPECIAL PARA GRÉS PORCELÂNICO GRESMASTER + JOGO

SPECIAL DRILL FOR PORCELAIN STONEWARE
FORET SPÉCIAL POUR GRÈS CÉRAME



139

BROCAS "MASTER GRANITO" PARA FURAR GRANITO + JOGO

"MASTER GRANITE" DRILLS
FORETS POUR PERCER LE GRANIT



140

BROCAS "EXTREME" ESPECIAL PARA MATERIAIS DUROS + JOGO

"EXTREME" SPECIAL DRILLS FOR HARD MATERIALS
FORETS "EXTREME" POUR MATÉRIEAUX DURS

METAL DURO



141

ÍNDICE DE FERRAMENTAS PARA CONSTRUÇÃO

INDEX FOR CONSTRUCTION TOOLS
INDEX DES OUTILS DE CONSTRUCTION

BROCAS PARA VIDRO COM PONTA EM METAL DURO

"EXTREME" SPECIAL DRILLS FOR HARD MATERIALS
FORETS "EXTREME" POUR MATÉRIEAUX DURS

METAL DURO



141

BROCAS DIAMANTADAS PARA GRÊS PORCELÂNICO E MATERIAIS DUROS + JOGO

DIAMOND DRILLS AND CORE DRILLS FOR SANDWARE, SANDSTONE AND VERY HARD MATERIALS
FORETS DIAMANTÉES AVEC COURONNE CONTINUE POUR GRÊS ET MATÉRIEAUX DURS



142

BROCAS DIAMANTADAS PARA GRÊS PORCELÂNICO COM ROSCA M14 + EXPOSITOR

DIAMOND DRILLS AND CORE DRILLS FOR SANDWARE, SANDSTONE WITH M14 THREAD
FORETS DIAMANTÉES AVEC COURONNE CONTINUE POUR GRÊS



143

VENTOSAS , ACESSÓRIOS E PASTA GEL PARA REFRIGERAÇÃO

SUCTION CUPS AND ACCESSORIES
VENTOUSES ET ACCESSOIRES



144

NOVO

COROAS SEGMENTADAS PROFISSIONAL PARA BETÃO + ADAPTADORES

DIAMOND CORE DRILLS WET CUTTING FOR DRILLING MACHINES
FORETS DIAMANTS COUPE A EAU POUR CAROTEUSES



145/146

NOVO

ESCAREADORES ESPECIAL GRÊS

COUNTERSINK STONEWARE
ALÉSIOIR POUR GRÊS



147

NOVO

COROAS DE REBAIXAR E MÓS TIPO TAÇA CÔNICA PARA PEDRA

REMOVING CROWNS AND CONICAL BOWL WHEELS FOR STONE
MEULES POUR APLANIR ET POLIR POUR LA PIERRE



148

DISCOS DE DIAMANTE

DIAMOND DISCS
DISQUES DIAMANT



149/150

NOVO

FRESAS PARA MARTELO COM DENTES EM METAL DURO COM FURO ROSCADO

HAMMER CUTTERS WITH TEETH IN CARBED METAL WITH THREADED HOLE
FRAISES À MARTEAU AVEC DENTS EN MÉTAL DUR AVEC ALÉSAGE FILETÉ

METAL DURO



151

FRESAS P/ MARTELO C/ DENTES EM METAL DURO C/ ROSCA E MOLA DE ACOPLAMENTO

HAMMER CUTTERS WITH TEETH IN CARBED METAL WITH THREAD AND COUPLING SPRING
FRAISES À MARTEAU AVEC DENTS EN MÉTAL DUR AVEC FILETAGE ET RESSORT D'ACCOUPLLEMENT

METAL DURO



152

FRESAS CRANEANAS BIMETÁLICAS HSS PARA AÇO E METAIS NÃO FERROSOS + JOGOS

HSS BIMETAL HOLE SAWS FOR STEEL AND NON-FERROUS METALS
SCIES À GRUE BIMÉTALLIQUES HSS POUR L'ACIER ET LES MÉTAUX NON FERREUX

HSS



153/154

FRESAS CRANEANAS BIMETÁLICAS HSS-CO 8% PARA INOX + JOGOS

HSS-CO 8% BIMETAL HOLE SAWS FOR INOX
SCIES À GRUE BIMÉTALLIQUES HSS-CO 8% POUR L'ACIER INOXYDABLE

HSS-CO



155/156

SERRA CRANEANA TCT COM DENTES EM METAL DURO + JOGO

TCT BIMETAL HOLE SAWS WITH TEETH IN CARBED METAL
SCIE À GRUE MULTI-MATERIAUX EN MÉTAL DUR DE TCT

METAL DURO



157

ADAPTADOR PARA SERRAS CRANEANAS ULTRA RÁPIDO MLOCK

QUICK CHANGE ARBOR FOR BIMETAL HOLE SAWS
ADAPTEUR DE SCIE À GRUE ULTRA RAPIDE MLOCK



158/159

ÍNDICE DE FERRAMENTAS PARA MADEIRA

INDEX TOOLS FOR WOOD

INDICE DES OUTILS POUR LE BOIS

BROCA PARA MADEIRA 4 CORTES CABO HEXAGONAL + JOGO

WOOD DRILL 4 CUTS HEXAGONAL HANDLE
FORET À BOIS 4 COUPES POIGNÉE HEXAGONALE

CROMO VANADIUM



162

BROCAS FORMA LEWIS PARA MADEIRA CABO "SDS PLUS"

LEWIS TYPE DRILLS FOR WOOD
FORETS SPIRALE VIS EN POINTE

CROMO VANADIUM



163

BROCAS FORMA LEWIS PARA MADEIRA CABO HEXAGONAL

LEWIS TYPE DRILLS FOR WOOD
FORETS SPIRALE VIS EN POINTE

CROMO VANADIUM



163

BROCAS PUAS PLANAS PARA MADEIRA E DERIVADOS (CABO HEXAGONAL) + JOGO

FLAT DRILLS FOR WOOD (HEXAGONAL SHANK)
MÊCHE PLATE (CÂBLE HEXAGONAL)

CROMO VANADIUM



164

BROCAS COM PONTA GUIA PARA MADEIRA DIN7487

CENTER POINT DRILLS FOR WOOD DIN7487
FORETS BOIS AUTO-CENTREUR

CROMO VANADIUM



165

BROCAS TIPO FORSTNER COM PONTA EM METAL DURO

FORSTNER TYPE DRILLS FOR WOOD (CARBIDE TIP)
MÊCHE À FAÇONNER (DENT CARBURE)

CROMO VANADIUM



165

SERRAS DE PASTILHA COM DENTES EM METAL DURO PARA MADEIRA

CARBIDE TIPPED CIRCULAR SAW BLADES
SCIES À PLAQUETTES AVEC DENTS EN MÉTAL DUR



166

SERRAS DE PASTILHA COM DENTES EM METAL DURO PARA LAMINADOS

CARBIDE TIPPED CIRCULAR SAW BLADES
SCIES À PLAQUETTES AVEC DENTS EN MÉTAL DUR

METAL DURO



166

SERRAS DE PASTILHA COM DENTES EM METAL DURO PARA DRY CUT (PAINÉIS SANDWICH)

CARBIDE TIPPED CIRCULAR SAW BLADES
SCIES CIRCULAIRES À DENTS EN MÉTAL DUR

METAL DURO



167

SERRAS DE PASTILHA COM DENTES EM METAL DURO PARA MÁQUINAS PORTÁTEIS

CARBIDE TIPPED CIRCULAR SAW BLADES
SCIES CIRCULAIRES À DENTS EN MÉTAL DUR

METAL DURO



167

ÍNDICE DE ACESSÓRIOS

INDEX ACCESSOIRES
INDICE DES ACCESSORIES

BUCHAS APERTO COM CHAVE E APERTO RÁPIDO

DRILL CHUCKS WITH KEY FOR PORTABLE POWER DRILLS
MANDRINS PRÉCISION PERÇEUSES AVEC CLEF



170

BUCHAS DE APERTO RÁPIDO - CAIXA PLÁSTICA E ACESSÓRIOS

ACCESSORIES AND ADAPTERS
ACCESSOIRES ET ADAPTATEURS



171

PONTO ROTATIVO STANDARD

REVOLVING TAILSTOCK CENTRES
POINTE TOURNANTE DE PRÉCISION



172

BUCHAS PARA TORNO E GRAMPOS

LATHE CHUCKS IN CAST IRON
MANDRINS DE TOUR À 3 ET 4 MORS DIN6350



172

CONES DE REDUÇÃO E ENCABADOUROS RETIFICADOS

REDUCTION MORSE TAPER SLEEVES AND TAPER DRILL CHUCK ARBORS
DOUILLES DE REDUCTION ET CÔNE DE MONTAGE POUR MANDRINS



173

PINÇAS DE PRECISÃO ER16, ER25, ER32, ER40

COLLET CHUCKS ER16, ER25, ER32, ER40
PINCES DE PRÉCISION ER16, ER25, ER32, ER40



174/175

JOGOS DE PINÇAS DE PRECISÃO ER16, ER25

COLLET CHUCKS SETS
JEUX PINCES DE PRÉCISION



176

CONES PARA PINÇAS DE PRECISÃO

COLLET CHUCKS ER16, ER25, ER32, ER40
PORTE-PINCES DE HAUTE PRÉCISION



177

SACA BOCADOS PARA UTILIZAÇÃO COM CHAVE + JOGOS

STANDARD BALL BEARING PUNCHES
EMPORTE PIECES STANDARD



178/179

BITS

BITS
EMBOUS



180 A 196

ADAPTADORES BITS

BITS ADAPTERS
ADAPTATEURS EMBOUTS



197

JOGOS E EXPOSITOR DE BITS

SETS BITBOX, MY BIT
JEUX BITBOX, MY BIT



198 A 201

LINHAS PARA EXPOSITOR

LINES FOR DISPLAYS
LIGNES POUR DISPLAYS



202/203

EXPOSITORES

CREATE YOUR DISPLAY
CRÉEZ VOTRE DISPLAY



204 A 210

ÍNDICE DA JK LIMAS

INDEX FOR JK FILES TOOLS
INDICE DE JK LIMES

LIMAS, CABOS E ACESSÓRIOS JK LIMAS
FILES, HANDLES ET ACCESSORIES
LIMES, CÂBLET ET ACCESSOIRES



214 A 219

ÍNDICE DA WIKUS

WIKUS INDEX
INDICE DE WIKUS

SERRAS PARA SERROTE MANUAL E MECÂNICO HSS E BIMETÁLICAS/ROLOS FITA
HSS AND BIMETALLIC MANUAL AND MECHANICAL SAWS
SCIES CIRCULAIRES À DENTS EN MÉTAL DUR

HSS



222/223

FITAS DE SERRA
BAND SAW BLADES
LAMES DE SCIE À RUBAN

HSS-CO



224 A 252

NOVO

OUTROS CATÁLOGOS

OTHER CATALOGUES
AUTRES CATALOGUES

IZAR, LTI, ROHM, INECO, ACCUD, PAG, CANELA



253 A 261

INFORMAÇÃO TÉCNICA

TECHNICAL INFORMATION
INFORMATIONS TECHNIQUES

TABELAS DE INFORMAÇÕES TÉCNICAS
TECHNICAL INFORMATION TABLES
TABLEAUX D'INFORMATIONS TECHNIQUES



264 A 272



METAL/MÉTAL



METAL

BROCAS CILÍNDRICAS RETIFICADAS HSS-G DIN338 - 135° SPLIT-POINT

HSS-G STRAIGHT SHANK DRILLS DIN338 - 135° SPLIT-POINT

FORETS CYLINDRIQUES RECTIFIÉS HSS-G DIN 338 - 135° SPLIT-POINT

HSS



CÓDIGO	Ø	l mm	L mm	PCS	€
MHSS01	1,00	12	34	10	0,21
MHSD01	1,10	14	36	10	0,43
MHSD02	1,20	16	38	10	0,43
MHSS02	1,25	16	38	10	0,21
MHSD03	1,30	16	38	10	0,43
MHSD04	1,40	18	40	10	0,43
MHSS03	1,50	18	40	10	0,21
MHSD05	1,60	20	43	10	0,44
MHSD06	1,70	20	43	10	0,44
MHSS04	1,75	22	46	10	0,21
MHSD07	1,80	22	46	10	0,44
MHSD08	1,90	22	46	10	0,44
MHSS05	2,00	24	49	10	0,21
MHSD09	2,10	24	49	10	0,47
MHSD10	2,20	27	53	10	0,47
MHSS06	2,25	27	53	10	0,21
MHSD11	2,30	27	53	10	0,49
MHSD12	2,40	30	57	10	0,49
MHSS07	2,50	30	57	10	0,21
MHSD13	2,60	30	57	10	0,49
MHSD14	2,70	33	61	10	0,49
MHSS08	2,75	33	61	10	0,27
MHSD15	2,80	33	61	10	0,49
MHSD16	2,90	33	61	10	0,49
MHSS09	3,00	33	61	10	0,27
MHSD17	3,10	36	65	10	0,61
MHSD18	3,20	36	65	10	0,61
MHSS10	3,25	36	65	10	0,33
MHSD19	3,30	36	65	10	0,61
MHSD20	3,40	39	70	10	0,61
MHSS11	3,50	39	70	10	0,33
MHSD21	3,60	39	70	10	0,67
MHSD22	3,70	39	70	10	0,67
MHSS12	3,75	39	70	10	0,42
MHSD23	3,80	43	75	10	0,67
MHSD24	3,90	43	75	10	0,67
MHSS13	4,00	43	75	10	0,42
MHSD25	4,10	43	75	10	0,71
MHSD26	4,20	43	75	10	0,71
MHSS14	4,25	43	75	10	0,51
MHSD27	4,30	47	80	10	0,71
MHSD28	4,40	47	80	10	0,71
MHSS15	4,50	47	80	10	0,51
MHSD29	4,60	47	80	10	0,85
MHSD30	4,70	47	80	10	0,85
MHSS16	4,75	47	80	10	0,60
MHSD31	4,80	52	86	10	0,85
MHSD32	4,90	52	86	10	0,85

CÓDIGO	Ø	l mm	L mm	PCS	€
MHSS17	5,00	52	86	10	0,60
MHSD33	5,10	52	86	10	0,98
MHSD34	5,20	52	86	10	0,98
MHSS18	5,25	52	86	10	0,75
MHSD35	5,30	52	86	10	0,98
MHSD36	5,40	57	93	10	0,98
MHSS19	5,50	57	93	10	0,75
MHSD37	5,60	57	93	10	1,08
MHSD38	5,70	57	93	10	1,08
MHSS20	5,75	57	93	10	0,84
MHSD39	5,80	57	93	10	1,08
MHSD40	5,90	57	93	10	1,08
MHSS21	6,00	57	93	10	0,84
MHSD41	6,10	63	101	10	1,22
MHSD42	6,20	63	101	10	1,22
MHSS22	6,25	63	101	10	0,99
MHSD43	6,30	63	101	10	1,22
MHSD44	6,40	63	101	10	1,22
MHSS23	6,50	63	101	10	0,99
MHSD45	6,60	63	101	10	1,46
MHSD46	6,70	63	101	10	1,46
MHSS24	6,75	69	109	10	1,32
MHSD47	6,80	69	109	10	1,46
MHSD48	6,90	69	109	10	1,46
MHSS25	7,00	69	109	10	1,20
MHSD49	7,10	69	109	5	1,91
MHSD50	7,20	69	109	5	1,91
MHSS26	7,25	69	109	10	1,35
MHSD51	7,30	69	109	5	1,91
MHSD52	7,40	69	109	5	1,91
MHSS27	7,50	69	109	10	1,35
MHSD53	7,60	75	117	5	1,97
MHSD54	7,70	75	117	5	1,97
MHSS28	7,75	75	117	10	1,50
MHSD55	7,80	75	117	5	1,97
MHSD56	7,90	75	117	5	1,97
MHSS29	8,00	75	117	10	1,50
MHSD57	8,10	75	117	5	2,30
MHSD58	8,20	75	117	5	2,30
MHSS30	8,25	75	117	10	1,71
MHSD59	8,30	75	117	5	2,30
MHSD60	8,40	75	117	5	2,30
MHSS31	8,50	75	117	10	1,71
MHSD61	8,60	81	125	5	2,49
MHSD62	8,70	81	125	5	2,49
MHSS32	8,75	81	125	10	2,01
MHSD63	8,80	81	125	5	2,49
MHSD64	8,90	81	125	5	2,49

BROCAS CILÍNDRICAS RETIFICADAS HSS-G DIN338 - 135° SPLIT-POINT

HSS-G STRAIGHT SHANK DRILLS DIN338 - 135° SPLIT-POINT

FORETS CYLINDRIQUES RECTIFIÉS HSS-G DIN 338 - 135° SPLIT-POINT

HSS



CÓDIGO	Ø	l mm	L mm	PCS	€
MHSS33	9,00	81	125	10	2,01
MHSD65	9,10	81	125	5	2,84
MHSD66	9,20	81	125	5	2,84
MHSS34	9,25	81	125	10	2,25
MHSD67	9,30	81	125	5	2,84
MHSD68	9,40	81	125	5	2,84
MHSS35	9,50	81	125	10	2,25
MHSD69	9,60	87	133	5	3,21
MHSD70	9,70	87	133	5	3,21
MHSS36	9,75	87	133	10	2,46
MHSD71	9,80	87	133	5	3,21
MHSD72	9,90	87	133	5	3,21
MHSS37	10,00	87	133	5	2,46
MHSS38	10,25	87	133	5	2,67
MHSS39	10,50	87	133	5	2,67
MHSS40	10,75	94	142	5	3,09
MHSS41	11,00	94	142	5	3,09
MHSS42	11,25	94	142	5	3,33
MHSS43	11,50	94	142	5	3,33
MHSS44	11,75	94	142	5	3,56
MHSS45	12,00	101	151	5	3,56
MHSS46	12,25	101	151	5	4,05
MHSS47	12,50	101	151	5	4,05
MHSS48	12,75	101	151	5	4,35
MHSS49	13,00	101	151	5	4,35
MHSS50	13,25	108	160	1	6,99
MHSS51	13,50	108	160	1	6,99
MHSS52	13,75	108	160	1	6,99

CÓDIGO	Ø	l mm	L mm	PCS	€
MHSS53	14,00	108	160	1	6,99
MHSS54	14,25	114	169	1	6,99
MHSS55	14,50	114	169	1	6,99
MHSS56	14,75	114	169	1	7,32
MHSS57	15,00	114	169	1	7,32
MHSS58	15,25	120	178	1	7,77
MHSS59	15,50	120	178	1	7,77
MHSS60	15,75	120	178	1	7,98
MHSS61	16,00	120	178	1	7,98
MHSS62	16,25	125	184	1	8,64
MHSS63	16,50	125	184	1	8,64
MHSS64	16,75	125	184	1	8,94
MHSS65	17,00	125	184	1	8,94
MHSS66	17,25	130	191	1	9,30
MHSS67	17,50	130	191	1	9,30
MHSS68	17,75	130	191	1	9,69
MHSS69	18,00	130	191	1	9,69
MHSS70	18,25	135	198	1	10,62
MHSS71	18,50	135	198	1	10,62
MHSS72	18,75	135	198	1	11,31
MHSS73	19,00	135	198	1	11,31
MHSS74	19,25	140	205	1	12,30
MHSS75	19,50	140	205	1	12,30
MHSS76	19,75	140	205	1	12,66
MHSS77	20,00	140	205	1	12,66



Jogos de Brocas HSS-G em Caixa Plástica

CÓDIGO	Ø MEDIDA	€
MHJ01	1-10 × 0,5 (19 brocas)	20,64
MHJ02	1-13 × 0,5 (25 brocas)	47,76

Caixas Plásticas Vazias para Jogos de Brocas

CÓDIGO	Ø MEDIDA	€
MCB200	1-10 × 0,5 (19 brocas)	8,92
MCB201	1-13 × 0,5 (25 brocas)	13,73

MALAS E EXPOSITORES DE BROCAS RETIFICADAS HSS-G

HSS-G DRILLS CASES AND DISPLAYS

COFFRETS ET PRÉSENTOIRS DE FORETS RECTIFIÉS HSS-G

HSS



Mala Metálica de Brocas HSS-G

Composição 170 brocas

∅ 10 brocas de cada:
1,00 - 1,50 - 2,00 - 2,50 - 3,00 - 3,50 - 4,00 - 4,50
5,00 - 5,50 - 6,00 - 6,50 - 7,00 - 7,50 - 8,00

∅ 5 brocas de cada:
8,50 - 9,00 - 9,50 - 10,00

CÓDIGO	€
MHJ10	133,56



Expositor em Acrílico de Brocas HSS-G

Composição 707 brocas

∅	UN	∅	UN	∅	UN	∅	UN
1,00	50	4,00	90	7,00	10	10,00	7
1,50	50	4,25	30	7,50	10	10,50	6
2,00	50	4,50	30	8,00	10	11,00	6
2,50	50	5,00	30	8,50	10	11,50	7
3,00	60	5,50	20	9,00	10	12,00	7
3,25	60	6,00	20	9,50	10	12,50	7
3,50	50	6,50	10			13,00	7



Expositor Metálico de Brocas HSS-G

Composição 2150 brocas

∅	UN	∅	UN	∅	UN	∅	UN
1,00	50	4,00	300	6,50	50	10,00	50
1,50	50	4,25	100	7,00	50	10,50	10
2,00	50	4,50	100	7,50	50	11,00	10
2,50	50	5,00	200	8,00	50	11,50	10
3,00	300	5,25	50	8,50	30	12,00	10
3,25	100	5,50	100	9,00	30	12,50	10
3,50	200	6,00	100	9,50	30	13,00	10

BROCAS CABO HEXAGONAL INTEGRAL HSS E HSS-CO

HSS AND HSS-CO 8% STRAIGHT SHANK DRILLS HEXAGONAL HANDLE
FORETS CYLINDRIQUES HSS ET HSS-CO CÂBLE HEXAGONAL

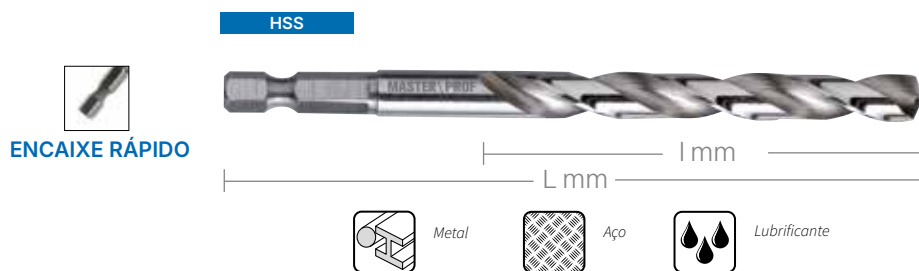

Brocas Hexagonais HSS

CÓDIGO	Ø	l mm	L mm	d mm	PCS	€
MBE100	1,5	12	60	6,35	10	2,92
MBE101	2	12	60	6,35	10	2,92
MBE102	2,5	12	60	6,35	10	2,92
MBE103	3	27	75	6,35	10	2,92
MBE104	3,25	27	75	6,35	10	2,92
MBE105	3,5	42	90	6,35	10	2,92
MBE106	4	42	90	6,35	10	2,92
MBE107	4,25	42	90	6,35	10	2,92
MBE108	4,5	42	90	6,35	10	2,92
MBE109	5	52	98	6,35	10	3,12

CÓDIGO	Ø	l mm	L mm	d mm	PCS	€
MBE110	5,5	52	98	6,35	10	3,12
MBE111	6	52	98	6,35	10	3,12
MBE112	6,5	63	107	6,35	10	3,12
MBE113	7	69	109	6,35	10	3,20
MBE114	7,5	69	109	6,35	10	3,44
MBE115	8	75	117	6,35	10	3,84
MBE116	8,5	75	117	6,35	10	3,92
MBE117	9	81	125	6,35	10	4,40
MBE118	9,5	81	125	6,35	10	4,56
MBE119	10	87	133	6,35	5	5,20



Jogo de Brocas Hexagonais HSS (10 PCS)

CÓDIGO	Ø MEDIDAS	€
MBE120	3-3,5-4-4,5-5-6-7-8-9-10	40,20

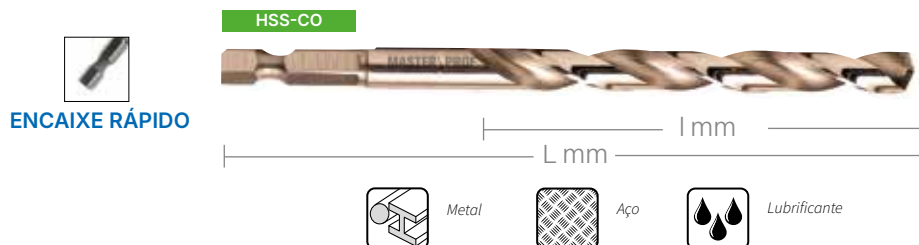

Brocas Hexagonais HSS-CO

CÓDIGO	Ø	l mm	L mm	d mm	PCS	€
MBECO100	1,5	12	60	6,35	10	3,48
MBECO101	2	12	60	6,35	10	3,48
MBECO102	2,5	12	60	6,35	10	3,48
MBECO103	3	27	75	6,35	10	3,48
MBECO104	3,25	27	75	6,35	10	3,48
MBECO105	3,5	42	90	6,35	10	3,48
MBECO106	4	42	90	6,35	10	3,48
MBECO107	4,25	42	90	6,35	10	3,48
MBECO108	4,5	42	90	6,35	10	3,48
MBECO109	5	52	98	6,35	10	3,80

CÓDIGO	Ø	l mm	L mm	d mm	PCS	€
MBECO110	5,5	52	98	6,35	10	3,80
MBECO111	6	52	98	6,35	10	3,80
MBECO112	6,5	63	107	6,35	10	3,80
MBECO113	7	69	109	6,35	10	3,96
MBECO114	7,5	69	109	6,35	5	5,04
MBECO115	8	75	117	6,35	10	5,68
MBECO116	8,5	75	117	6,35	10	5,84
MBECO117	9	81	125	6,35	10	6,56
MBECO118	9,5	81	125	6,35	10	6,88
MBECO119	10	87	133	6,35	5	7,84



Jogo de Brocas Hexagonais HSS-CO (10 PCS)

CÓDIGO	Ø MEDIDAS	€
MBECO120	3-3,5-4-4,5-5-6-7-8-9-10	55,12

BROCAS CILÍNDRICAS RETIFICADAS LONGAS HSS DIN340N - 135° SPLIT-POINT

HSS STRAIGHT SHANK LONG DRILLS DIN340N - 135° SPLIT-POINT

FORETS CYLINDRIQUES SÉRIE LONGUE HSS DIN340N - 135° SPLIT-POINT

HSS



CÓDIGO	Ø	l mm	L mm	PCS	€
MHSSL001	1,50	45	70	10	1,51
MHSSL002	1,75	53	80	10	1,68
MHSSL003	2,00	56	85	10	1,61
MHSSL004	2,25	59	90	10	1,76
MHSSL005	2,50	62	95	10	1,68
MHSSL006	2,75	66	100	10	1,95
MHSSL007	3,00	66	100	10	1,95
MHSSL008	3,25	69	106	10	2,11
MHSSL009	3,50	73	112	10	2,07
MHSSL010	3,75	73	112	10	2,20
MHSSL011	4,00	78	119	10	2,10
MHSSL012	4,25	78	119	10	2,66
MHSSL013	4,50	82	126	10	2,70
MHSSL014	4,75	82	126	10	2,77
MHSSL015	5,00	87	132	10	2,63
MHSSL016	5,25	87	132	10	3,64
MHSSL017	5,50	91	139	10	3,64
MHSSL018	5,75	91	139	10	3,98
MHSSL019	6,00	91	139	10	3,98
MHSSL020	6,25	97	148	10	4,50
MHSSL021	6,50	97	148	10	4,28
MHSSL022	6,75	97	148	10	5,24
MHSSL023	7,00	102	156	10	4,81
MHSSL024	7,25	102	156	10	5,92
MHSSL025	7,50	102	156	10	5,62
MHSSL026	7,75	109	165	10	6,73
MHSSL027	8,00	109	165	5	6,40
MHSSL028	8,25	109	165	5	8,86

CÓDIGO	Ø	l mm	L mm	PCS	€
MHSSL029	8,50	109	165	5	8,86
MHSSL030	8,75	115	175	5	9,27
MHSSL031	9,00	115	175	5	9,27
MHSSL032	9,25	115	175	5	10,42
MHSSL033	9,50	115	175	5	9,93
MHSSL034	9,75	121	184	5	10,29
MHSSL035	10,00	121	184	5	9,79
MHSSL036	10,50	121	184	5	11,10
MHSSL037	11,00	128	195	5	12,00
MHSSL038	11,50	128	195	5	13,24
MHSSL039	12,00	134	205	5	14,43
MHSSL040	12,50	134	205	5	14,92
MHSSL041	13,00	134	205	5	17,47
MHSSL042	13,50	140	214	5	24,08
MHSSL043	14,00	140	214	5	24,08
MHSSL044	14,50	144	220	5	34,09
MHSSL045	15,00	144	220	5	32,48
MHSSL046	15,50	149	227	5	39,58
MHSSL047	16,00	149	227	5	37,70
MHSSL048	16,50	154	235	5	39,08
MHSSL049	17,00	154	235	5	40,17
MHSSL050	17,50	158	241	5	44,59
MHSSL051	18,00	158	241	5	45,34
MHSSL052	18,50	162	247	5	51,48
MHSSL053	19,00	162	247	5	52,51
MHSSL054	19,50	166	254	5	55,64
MHSSL055	20,00	166	254	5	56,27

BROCAS CILÍNDRICAS RETIFICADAS HSS-CO 8% DIN338 - 135° SPLIT-POINT

HSS-CO 8% STRAIGHT SHANK DRILLS DIN338 - 135° SPLIT-POINT

FORETS CYLINDRIQUES RECTIFIÉS HSS-CO 8% DIN338 - 135° - SPLIT-POINT

HSS-CO



HSS-CO
8%



DIN
338

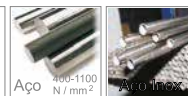

CÓDIGO	Ø	l mm	L mm	PCS	€
MOCO01	1,00	12	34	10	0,37
MOCO02	1,25	16	38	10	0,46
MOCO03	1,50	18	40	10	0,46
MOCO04	1,75	22	46	10	0,50
MOCO05	2,00	24	49	10	0,50
MOCO06	2,25	27	53	10	0,51
MOCO07	2,50	30	57	10	0,51
MOCO08	2,75	33	61	10	0,67
MOCO09	3,00	33	61	10	0,67
MOCO10	3,25	36	65	10	0,72
MOCO11	3,50	39	70	10	0,78
MOCO12	3,75	39	70	10	0,84
MOCO13	4,00	43	75	10	0,84
MOCO14	4,25	43	75	10	1,02
MOCO15	4,50	47	80	10	1,02
MOCO16	4,75	47	80	10	1,23
MOCO17	5,00	52	86	10	1,23
MOCO18	5,25	52	86	10	1,35
MOCO19	5,50	57	93	10	1,35
MOCO20	5,75	57	93	10	1,56
MOCO21	6,00	57	93	10	1,56
MOCO22	6,25	63	101	10	1,86
MOCO23	6,50	63	101	10	1,86
MOCO24	6,75	69	109	10	2,25
MOCO25	7,00	69	109	10	2,25

CÓDIGO	Ø	l mm	L mm	PCS	€
MOCO26	7,25	69	109	10	2,55
MOCO27	7,50	69	109	10	2,55
MOCO28	7,75	75	117	10	3,03
MOCO29	8,00	75	117	10	3,03
MOCO30	8,25	75	117	10	3,69
MOCO31	8,50	75	117	10	3,69
MOCO32	8,75	81	125	10	4,38
MOCO33	9,00	81	125	10	4,38
MOCO34	9,25	81	125	10	4,83
MOCO35	9,50	81	125	10	4,83
MOCO36	9,75	87	133	10	5,61
MOCO37	10,00	87	133	5	5,61
MOCO38	10,25	87	133	5	5,70
MOCO39	10,50	87	133	5	5,70
MOCO40	10,75	94	142	5	6,54
MOCO41	11,00	94	142	5	6,54
MOCO42	11,25	94	142	5	7,17
MOCO43	11,50	94	142	5	7,17
MOCO44	11,75	94	142	5	8,16
MOCO45	12,00	101	151	5	8,16
MOCO46	12,25	101	151	5	8,76
MOCO47	12,50	101	151	5	8,76
MOCO48	12,75	101	151	5	9,45
MOCO49	13,00	101	151	5	9,45

HSS-CO



Jogos de Brocas HSS-CO 8% em Caixa Plástica

CÓDIGO	Ø MEDIDA	€
MOC01	1-10 × 0,5 (19 brocas)	39,84
MOC02	1-13 × 0,5 (25 brocas)	82,35

Caixas Plásticas Vazias para Jogos de Brocas

CÓDIGO	Ø MEDIDA	€
MCB200	1-10 × 0,5 (19 brocas)	8,92
MCB201	1-13 × 0,5 (25 brocas)	13,73

MALAS E EXPOSITORES DE BROCAS RETIFICADAS HSS-CO 8

HSS-CO 8% DRILLS CASES AND DISPLAYS

COFFRETS ET PRÉSENTOIRS DE FORETS RECTIFIÉS HSS-CO 8%

HSS-CO



Mala Metálica de Brocas HSS-CO 8%

Composição 170 brocas

10 brocas de cada:

1,00 - 1,50 - 2,00 - 2,50 - 3,00 - 3,50 - 4,00 - 4,50
5,00 - 5,50 - 6,00 - 6,50 - 7,00 - 7,50 - 8,00

5 brocas de cada:

8,50 - 9,00 - 9,50 - 10,00

CÓDIGO	€
MOC10	321,87



Expositor em Acrílico de Brocas HSS-CO 8%

Composição 707 brocas

Ø	UN	Ø	UN	Ø	UN	Ø	UN
1,00	50	4,00	90	7,00	10	10,00	7
1,50	50	4,25	30	7,50	10	10,50	6
2,00	50	4,50	30	8,00	10	11,00	6
2,50	50	5,00	30	8,50	10	11,50	7
3,00	60	5,50	20	9,00	10	12,00	7
3,25	60	6,00	20	9,50	10	12,50	7
3,50	50	6,50	10			13,00	7



Expositor Metálico de Brocas HSS-CO 8%

Composição 895 brocas

Ø	UN	Ø	UN	Ø	UN	Ø	UN
1,00	20	4,00	100	6,50	20	10,00	20
1,50	20	4,25	50	7,00	20	10,50	5
2,00	20	4,50	50	7,50	10	11,00	5
2,50	50	5,00	100	8,00	20	11,50	5
3,00	100	5,25	30	8,50	10	12,00	10
3,25	50	5,50	50	9,00	10	12,50	5
3,50	50	6,00	50	9,50	10	13,00	5

BROCAS CILÍNDRICAS RETIFICADAS SPEEDMASTER HSS-G DIN338

HSS-G SPEEDMASTER DRILLS

FORETS CYLINDRIQUES RECTIFIÉS HSS-G DIN338 SPEEDMASTER

HSS

Faceta (com Faceta a partir de 5 mm)



HSS-G

DIN 338



CÓDIGO	Ø	l mm	L mm	PCS	€
MTSP001	1,00	12	34	10	1,27
MTSP002	1,25	16	38	10	1,40
MTSP003	1,50	18	40	10	1,27
MTSP004	1,75	22	46	10	1,40
MTSP005	2,00	24	49	10	1,27
MTSP006	2,25	27	53	10	1,42
MTSP007	2,50	30	57	10	1,30
MTSP008	2,75	33	61	10	1,53
MTSP009	3,00	33	61	10	1,36
MTSP010	3,25	36	65	10	1,78
MTSP011	3,50	39	70	10	1,62
MTSP012	3,75	39	70	10	1,96
MTSP013	4,00	43	75	10	1,78
MTSP014	4,25	43	75	10	2,13
MTSP015	4,50	47	80	10	1,93
MTSP016	4,75	47	80	10	2,44
MTSP017	5,00	52	86	10	2,30
MTSP018	5,25	52	86	10	3,16
MTSP019	5,50	57	93	10	2,86
MTSP020	5,75	57	93	10	3,42
MTSP021	6,00	57	93	10	3,10
MTSP022	6,25	63	101	10	4,03
MTSP023	6,50	63	101	10	3,56
MTSP024	6,75	69	109	10	4,72
MTSP025	7,00	69	109	10	4,28
MTSP026	7,25	69	109	10	5,05
MTSP027	7,50	69	109	5	4,59
MTSP028	7,75	75	117	5	5,94
MTSP029	8,00	75	117	5	5,62
MTSP030	8,25	75	117	5	6,48
MTSP031	8,50	75	117	5	6,09
MTSP032	8,75	81	125	5	7,69
MTSP033	9,00	81	125	5	6,99
MTSP034	9,25	81	125	5	8,14
MTSP035	9,50	81	125	5	7,63
MTSP036	9,75	87	133	5	9,23
MTSP037	10,00	87	133	5	8,58
MTSP038	10,25	87	133	5	10,19
MTSP039	10,50	87	133	5	9,25
MTSP040	10,75	94	142	5	11,81
MTSP041	11,00	94	142	5	10,75
MTSP042	11,25	94	142	5	12,85
MTSP043	11,50	94	142	5	11,67
MTSP044	11,75	94	142	5	14,33
MTSP045	12,00	101	151	5	13,02
MTSP046	12,25	101	151	5	15,44
MTSP047	12,50	101	151	5	14,05
MTSP048	12,75	101	151	5	16,45
MTSP049	13,00	101	151	5	14,97



Jogos (Caixa Plástica)

CÓDIGO	Ø	MEDIDA	€
MTSPJ01	1-10	× 0,5 (19 uni.)	67,68
MTSPJ02	1-13	× 0,5 (25 uni.)	143,31



Linha para Expositor

Composição 124 brocas

UN	MEDIDA
15	3
15	4
15	5
15	6
15	8
10	3,5
10	4,5
10	5,5
10	6,5
6	10
3	12



Mala Metálica

Composição 116 brocas Medida 1-10 × 0,5

Ø	UN	Ø	UN
1,00	10	5,50	3
1,50	10	6,00	3
2,00	10	6,50	3
2,50	10	7,00	3
3,00	10	7,50	3
3,50	10	8,00	3
4,00	10	8,50	2
4,50	10	9,00	2
5,00	10	9,50	2
		10,00	2

CÓDIGO	€
MTSPJ03	284,14



Expositor Metálico

Composição 168 brocas Medida 1-13 × 0,5

Ø	UN	Ø	UN
1,00	10	7,00	5
1,50	10	7,50	5
2,00	10	8,00	5
2,50	10	8,50	5
3,00	10	9,00	5
3,50	10	9,50	5
4,00	10	10,00	5
4,50	10	10,50	3
5,00	10	11,00	3
5,50	10	11,50	3
6,00	10	12,00	3
6,50	5	12,50	3
		13,00	3

BROCAS CILÍNDRICA COM PONTA ESCALONADA STEP HSS-CO

CYLINDRICAL DRILLS WITH STEPPED TIP STEP

FORETS CYLINDRIQUES RECTIFIÉES À POINTE ÉTAGÉE STEP HSS-CO

HSS-CO



Metais



Inox



Plástico

DIN
338



Alumínio



Aço



Madeira



broca
geometria
especial
com ponta
escalonada



Broca
tradicional

Broca
STEP

Furos
perfeitos
Especial para Tubo

Furos perfeitos

A geometria especial e ponta escalonada ($\emptyset \geq 3\text{mm}$) permite fazer furos extremamente precisos e perfeitamente circulares.

30% MAIS RÁPIDA

Graças à geometria especial e ponta escalonada, a broca é 30% mais rápida que uma broca convencional.

Alta durabilidade

Fabricado em aço HSS AISI M42 de alta qualidade que garante um alto desempenho constante e uma vida útil prolongada, mesmo em condições de uso intensivo.

Prática, também em superfícies curvas

A ponta auto-centrante garante um furo fácil e perfeito, mesmo em superfícies curvas.



<5 d



$\emptyset \geq 3\text{mm}$



130°
W 27°

CÓDIGO	Ø	l mm	L mm	Nº Degraus	PCS	€
MBPE101	1	12	34	-	10	1,16
MBPE102	1,5	18	40	-	10	1,16
MBPE103	2	24	49	-	10	1,16
MBPE104	2,5	30	57	-	10	1,18
MBPE105	3	33	61	1	10	1,26
MBPE106	3,2	36	65	1	10	1,62
MBPE107	3,5	39	70	1	10	1,48
MBPE108	4	43	75	1	10	1,62
MBPE109	4,2	43	75	2	10	1,86
MBPE110	4,5	47	80	2	10	1,94
MBPE111	4,8	52	86	2	10	1,75
MBPE112	5	52	86	2	10	2,11
MBPE113	5,2	52	86	2	10	2,87
MBPE114	5,5	57	93	3	10	2,66
MBPE115	6	57	93	3	10	2,84
MBPE116	6,5	63	101	3	10	3,34
MBPE117	7	69	109	4	10	3,91
MBPE118	7,5	69	109	4	10	4,18
MBPE119	8	75	117	5	10	5,15
MBPE120	8,5	75	117	5	10	5,57
MBPE121	9	81	125	5	10	6,37
MBPE122	9,5	81	125	6	10	6,98
MBPE123	10	87	133	6	5	8,02
MBPE124	10,5	87	133	7	5	8,69
MBPE125	11	94	142	7	5	9,80
MBPE126	11,5	94	142	8	5	10,65
MBPE127	12	101	151	8	5	12,23
MBPE128	12,5	101	151	8	5	13,11
MBPE129	13	101	151	8	5	14,02



JOGOS DE BROCAS ESCALONADAS
STEP HSS-CO 1-10MM

Composição 19 Brocas

1 A 10 X 0,5 MM

CÓDIGO €
MBPE150 61,36



JOGOS DE BROCAS ESCALONADAS
STEP HSS-CO 1-13MM

Composição 25 Brocas

1 A 13 X 0,5 MM

CÓDIGO €
MBPE151 127,10

BROCAS CILÍNDRICAS REBAIXADAS HSS E HSS-CO

HSS AND HSS-CO REDUCED SHANK TWIST DRILLS
FORETS CYLINDRIQUES REDUITE HSS ET HSS-CO

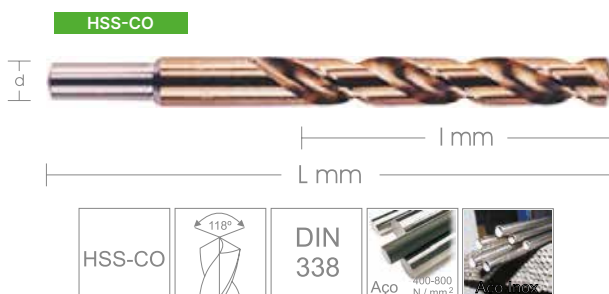
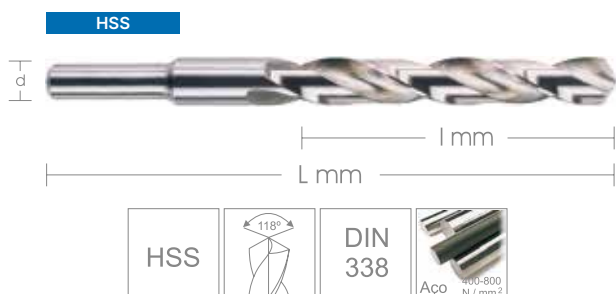

Brocas Cilíndricas Rebaixadas HSS

CÓDIGO	Ø	d	l mm	L mm	PCS	€
MHSSR20	10,50	10,00	87	133	1	3,02
MHSSR21	11,00	10,00	94	142	1	3,44
MHSSR22	11,50	10,00	94	142	1	3,72
MHSSR23	12,00	10,00	101	151	1	3,87
MHSSR24	12,50	10,00	101	151	1	4,47
MHSSR25	13,00	10,00	101	151	1	4,81
MHSSR26	13,50	12,70	108	160	1	6,13
MHSSR27	14,00	12,70	108	160	1	6,30
MHSSR28	14,50	12,70	114	169	1	6,99
MHSSR29	15,00	12,70	114	169	1	7,35
MHSSR30	15,50	12,70	120	178	1	8,04
MHSSR31	16,00	12,70	120	178	1	8,46
MHSSR32	16,50	12,70	125	184	1	9,12
MHSSR33	17,00	12,70	125	184	1	9,54
MHSSR34	17,50	12,70	130	191	1	10,35
MHSSR35	18,00	12,70	130	191	1	10,83
MHSSR36	18,50	12,70	135	198	1	11,76
MHSSR37	19,00	12,70	135	198	1	12,27
MHSSR38	19,50	12,70	140	205	1	13,74
MHSSR39	20,00	12,70	140	205	1	14,31
MHSSR40	20,50	12,70	145	205	1	16,56
MHSSR41	21,00	12,70	145	205	1	17,22
MHSSR42	21,50	12,70	150	210	1	18,42
MHSSR43	22,00	12,70	150	210	1	19,14
MHSSR44	22,50	12,70	150	210	1	20,79
MHSSR45	23,00	12,70	150	210	1	21,60
MHSSR46	23,50	12,70	160	220	1	22,98
MHSSR47	24,00	12,70	160	220	1	23,85
MHSSR48	24,50	12,70	160	220	1	25,35
MHSSR49	25,00	12,70	160	220	1	26,46

Brocas Cilíndricas Rebaixadas HSS-CO

CÓDIGO	Ø	d	l mm	L mm	PCS	€
MOCOR20	10,50	10,00	87	133	1	5,93
MOCOR21	11,00	10,00	94	142	1	6,80
MOCOR22	11,50	10,00	94	142	1	7,42
MOCOR23	12,00	10,00	101	151	1	8,41
MOCOR24	12,50	10,00	101	151	1	8,99
MOCOR25	13,00	10,00	101	151	1	9,63
MOCOR26	13,50	12,70	108	160	1	10,23
MOCOR27	14,00	12,70	108	160	1	10,77
MOCOR28	14,50	12,70	114	169	1	12,00
MOCOR29	15,00	12,70	114	169	1	12,63
MOCOR30	15,50	12,70	120	178	1	13,89
MOCOR31	16,00	12,70	120	178	1	14,55
MOCOR32	16,50	12,70	125	184	1	15,75
MOCOR33	17,00	12,70	125	184	1	16,50
MOCOR34	17,50	12,70	130	191	1	17,94
MOCOR35	18,00	12,70	130	191	1	18,78
MOCOR36	18,50	12,70	135	198	1	20,43
MOCOR37	19,00	12,70	135	198	1	21,33
MOCOR38	19,50	12,70	140	205	1	23,88
MOCOR39	20,00	12,70	140	205	1	24,84
MOCOR40	20,50	12,70	145	205	1	28,80
MOCOR41	21,00	12,70	145	205	1	30,00
MOCOR42	21,50	12,70	150	210	1	32,13
MOCOR43	22,00	12,70	150	210	1	33,39
MOCOR44	22,50	12,70	150	210	1	36,27
MOCOR45	23,00	12,70	150	210	1	37,71
MOCOR46	23,50	12,70	160	220	1	40,14
MOCOR47	24,00	12,70	160	220	1	41,67
MOCOR48	24,50	12,70	160	220	1	44,34
MOCOR49	25,00	12,70	160	220	1	46,17

BROCAS CILÍNDRICAS RETIFICADAS HSS DIN1897 - EXTRA CURTA

HSS STRAIGHT SHANK STUB DRILLS DIN1897

FORETS CYLINDRIQUES SÉRIE EXTRA COURTE HSS DIN1897

HSS



CÓDIGO	Ø	l mm	L mm	PCS	€
MHSE01	2,00	12	38	10	0,56
MHSE02	2,25	13	40	10	0,65
MHSE03	2,50	14	43	10	0,63
MHSE04	2,75	16	46	10	0,85
MHSE05	3,00	16	46	10	0,84
MHSE06	3,25	18	49	10	0,86
MHSE07	3,50	20	52	10	0,89
MHSE08	3,75	20	52	10	0,95
MHSE09	4,00	22	55	10	0,89
MHSE10	4,25	22	55	10	0,81
MHSE26	4,30	22	55	10	0,85
MHSE11	4,50	24	58	10	0,95
MHSE12	4,75	24	58	10	0,97
MHSE13	5,00	26	62	10	0,97
MHSE14	5,25	26	62	10	1,07
MHSE15	5,50	28	66	10	1,07
MHSE16	5,75	28	66	10	1,28
MHSE17	6,00	28	66	10	1,21
MHSE18	6,50	31	70	10	1,81
MHSE19	7,00	34	74	10	2,02
MHSE20	7,50	34	74	5	2,43
MHSE21	8,00	37	79	5	2,95
MHSE22	8,50	37	79	5	3,63
MHSE23	9,00	40	84	5	4,37
MHSE24	9,50	40	84	5	5,13
MHSE25	10,00	43	89	5	5,74
MHSE27	10,50	43	89	5	4,10
MHSE28	11,00	47	95	5	4,75
MHSE29	11,50	47	95	5	5,05
MHSE30	12,00	51	102	5	5,52
MHSE31	12,50	51	102	5	5,96
MHSE32	13,00	51	102	5	6,22



Jogos de Brocas Extra Curtas em Caixa Plástica

CÓDIGO	Ø MEDIDA	€
MHSE91	1-10 × 0,5mm (19 brocas)	36,83
MHSE92	1-13 × 0,5mm (25 brocas)	74,90

BROCAS COM PONTA EM METAL DURO E METAL DURO INTEGRAL PARA INOX DIN 338

HSS-CO FOR STAINLESS STEEL AND CARBIDE TIPPED DRILLS

FORETS CYLINDRIQUES HSS-CO POUR ACIER INOXYDABLE ET FORETS CYLINDRIQUES POINTE CARBURE

Ponta em Metal Duro

METAL DURO

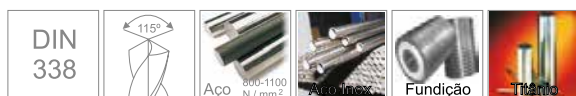

Metal Duro Integral

METAL DURO

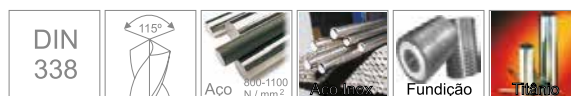

Brocas Cilíndricas com Ponta em Metal Duro

CÓDIGO	Ø	l mm	L mm	PCS	€
MBO200	2,00	24	49	1	20,58
MBO202	2,50	30	57	1	20,58
MBO204	3,00	33	61	1	20,58
MBO206	3,50	39	70	1	20,58
MBO208	4,00	43	75	1	12,91
MBO210	4,50	47	80	1	12,91
MBO212	5,00	52	86	1	14,39
MBO214	5,50	57	93	1	14,39
MBO216	6,00	57	93	1	15,24
MBO218	6,50	63	103	1	15,57
MBO220	7,00	69	109	1	17,17
MBO222	7,50	69	109	1	18,50
MBO224	8,00	75	117	1	20,83
MBO226	8,50	75	117	1	20,31
MBO228	9,00	81	125	1	22,88
MBO230	9,50	81	125	1	25,11
MBO232	10,00	87	133	1	26,07
MBO234	10,50	94	142	1	28,56
MBO236	11,00	94	142	1	30,79
MBO238	11,50	94	142	1	32,70
MBO240	12,00	101	151	1	35,32
MBO242	12,50	101	151	1	37,45
MBO244	13,00	101	151	1	41,33

Brocas Cilíndricas em Metal Duro Integral

CÓDIGO	Ø	l mm	L mm	PCS	€
MBMD01	1,00	12	34	1	6,46
MBMD02	1,25	16	38	1	6,46
MBMD03	1,50	18	40	1	7,16
MBMD05	2,00	24	49	1	10,74
MBMD06	2,25	27	53	1	10,74
MBMD07	2,50	30	57	1	13,94
MBMD09	3,00	33	61	1	15,83
MBMD10	3,25	36	65	1	15,83
MBMD11	3,50	39	70	1	19,09
MBMD13	4,00	43	75	1	22,94
MBMD14	4,25	47	80	1	22,94
MBMD15	4,50	47	80	1	27,00
MBMD16	4,75	52	86	1	27,00
MBMD17	5,00	52	86	1	31,55
MBMD18	5,25	52	86	1	31,55
MBMD19	5,50	57	93	1	37,90
MBMD21	6,00	57	93	1	39,90
MBMD23	6,50	63	101	1	50,53
MBMD25	7,00	69	109	1	58,18
MBMD27	7,50	69	109	1	65,17
MBMD29	8,00	75	117	1	72,17
MBMD31	8,50	75	117	1	81,82
MBMD33	9,00	81	125	1	95,15
MBMD35	9,50	81	125	1	106,00
MBMD37	10,00	87	133	1	112,45
MBMD39	10,50	87	133	1	131,53
MBMD41	11,00	94	142	1	152,73
MBMD52	11,50	94	142	1	167,75
MBMD42	12,00	101	151	1	189,06

BROCAS HELICOIDAIS CABO CÓNICO HSS DIN345

HSS MORSE TAPER SHANK DRILLS DIN345

FORETS HÉLICOÏDAUX CÂBLE CONIQUE HSS DIN345

HSS



CÓDIGO	Ø	l mm	L mm	cm	PCS	€
MICON011	10,00	87	168	1	1	5,90
MICON013	11,00	94	175	1	1	5,95
MICON015	12,00	101	182	1	1	6,13
MICON017	13,00	101	182	1	1	6,44
MICON018	13,50	108	189	1	1	6,97
MICON019	14,00	108	189	1	1	7,32
MICON020	14,50	114	212	2	1	9,21
MICON021	15,00	114	212	2	1	9,21
MICON022	15,50	120	218	2	1	9,24
MICON023	16,00	120	218	2	1	9,42
MICON024	16,50	125	223	2	1	9,80
MICON025	17,00	125	223	2	1	10,08
MICON026	17,50	130	228	2	1	10,36
MICON027	18,00	130	228	2	1	11,31
MICON028	18,50	130	228	2	1	11,97
MICON029	19,00	135	233	2	1	13,06
MICON030	19,50	140	238	2	1	14,46
MICON031	20,00	140	238	2	1	15,75
MICON032	20,50	150	248	2	1	16,35
MICON033	21,00	150	248	2	1	17,26
MICON034	21,50	150	248	2	1	17,71
MICON035	22,00	150	248	2	1	18,83
MICON036	22,50	155	253	2	1	19,32
MICON037	23,00	155	253	2	1	20,55
MICON038	23,50	155	276	3	1	23,91
MICON039	24,00	160	281	3	1	23,91
MICON040	24,50	160	281	3	1	24,12
MICON041	25,00	160	281	3	1	24,92
MICON042	25,50	165	286	3	1	26,01
MICON043	26,00	165	286	3	1	27,86
MICON044	26,50	165	286	3	1	27,90
MICON045	27,00	170	291	3	1	29,93
MICON046	27,50	170	291	3	1	31,82
MICON047	28,00	170	291	3	1	31,89
MICON048	28,50	175	296	3	1	32,45
MICON049	29,00	175	296	3	1	34,86
MICON050	29,50	175	296	3	1	36,61
MICON051	30,00	175	296	3	1	36,61
MICON052	30,50	180	301	3	1	39,13
MICON053	31,00	180	301	3	1	39,13
MICON054	31,50	180	301	3	1	44,24
MICON055	32,00	185	334	4	1	46,24
MICON056	32,50	185	334	4	1	48,51
MICON057	33,00	185	334	4	1	48,51
MICON058	33,50	185	334	4	1	49,88
MICON059	34,00	190	339	4	1	48,70
MICON060	34,50	190	339	4	1	52,22
MICON061	35,00	190	339	4	1	53,75

CÓDIGO	Ø	l mm	L mm	cm	PCS	€
MICON062	35,50	190	339	4	1	57,75
MICON063	36,00	195	344	4	1	58,08
MICON064	36,50	195	344	4	1	62,24
MICON065	37,00	195	344	4	1	64,00
MICON066	37,50	195	344	4	1	64,00
MICON067	38,00	200	349	4	1	64,00
MICON068	38,50	200	349	4	1	64,00
MICON069	39,00	200	349	4	1	72,73
MICON070	39,50	200	349	4	1	72,73
MICON071	40,00	205	354	4	1	72,73
MICON072	40,50	205	354	4	1	72,73
MICON073	41,00	205	354	4	1	78,71
MICON074	41,50	205	354	4	1	78,71
MICON075	42,00	205	354	4	1	79,41
MICON076	42,50	210	359	4	1	80,98
MICON077	43,00	210	359	4	1	79,41
MICON078	43,50	210	359	4	1	88,79
MICON079	44,00	210	359	4	1	99,64
MICON080	44,50	210	359	4	1	106,45
MICON081	45,00	210	359	4	1	99,64
MICON082	45,50	215	364	4	1	103,93
MICON083	46,00	215	364	4	1	100,87
MICON084	46,50	215	364	4	1	114,28
MICON085	47,00	215	364	4	1	120,71
MICON086	47,50	215	364	4	1	124,87
MICON087	48,00	220	369	4	1	120,71
MICON088	48,50	220	369	4	1	135,97
MICON089	49,00	220	369	4	1	120,71
MICON090	49,50	220	369	4	1	139,50
MICON091	50,00	220	369	4	1	126,74
MICON092	51,00	225	412	5	1	154,37
MICON093	52,00	225	412	5	1	154,37
MICON094	53,00	225	412	5	1	154,37
MICON095	54,00	230	417	5	1	167,26
MICON096	55,00	230	417	5	1	167,26
MICON097	56,00	230	417	5	1	188,62
MICON098	57,00	235	422	5	1	188,62
MICON099	58,00	235	422	5	1	202,44
MICON100	59,00	235	422	5	1	202,44
MICON101	60,00	235	422	5	1	202,44
MICON102	61,00	240	427	5	1	284,90
MICON103	62,00	240	427	5	1	284,90
MICON104	63,00	240	427	5	1	284,90
MICON105	64,00	245	432	5	1	304,10
MICON106	65,00	245	432	5	1	304,10

Outras medidas sob consulta

JOGO DE BROCAS HELICOIDAIS CABO CÓNICO HSS DIN345

HSS MORSE TAPER SHANK DRILLS SET DIN345

COFFRET FORETS HÉLICOÏDAUX CÂBLE CONIQUE HSS DIN345

HSS



Mala

Composição 9 brocas

Ø	UN
14,00	1
16,00	1
18,00	1
20,00	1
22,00	1
24,00	1
26,00	1
28,00	1
30,00	1

CÓDIGO

€

MICON150

172,92

BROCAS DE CENTRAR TIPO A HSS DIN333-A 118°

HSS DOUBLE CENTER DRILLS DIN333-A 118°
FORETS À CENTRER HSS DIN333-A 118°

HSS

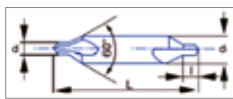

HSS



DIN
333A

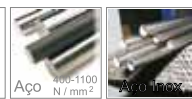

CÓDIGO	Ød mm	Ød1 mm	l mm	L mm	PCS	€
MBSO70	1,00 x 3,15	1,30	31,50	1	6,84	
MBSO71	1,25 x 3,15	1,60	31,50	1	6,84	
MBSO72	1,60 x 4,00	2,00	35,50	1	5,28	
MBSO73	2,00 x 5,00	2,50	40,00	1	5,28	
MBSO74	2,50 x 6,30	3,10	45,00	1	6,30	
MBSO75	3,15 x 8,00	3,90	50,00	1	6,98	
MBSO76	4,00 x 10,00	5,00	56,00	1	10,07	
MBSO77	5,00 x 12,50	6,30	63,00	1	16,86	
MBSO78	6,30 x 16,00	8,00	71,00	1	24,15	

CÓDIGO	Ød mm	Ød1 mm	l mm	L mm	PCS	€
MBSO79	10,00 x 25,00	12,80	100,00	1	66,68	
MBSO80	1,25 x 4,00	1,60	35,50	1	5,62	
MBSO81	1,60 x 5,00	2,00	40,00	1	5,62	
MBSO82	2,00 x 6,30	2,50	45,00	1	6,15	
MBSO83	2,50 x 8,00	3,10	50,00	1	6,98	
MBSO84	3,15 x 10,00	3,90	56,00	1	8,20	
MBSO85	4,00 x 12,50	5,00	63,00	1	12,33	
MBSO86	5,00 x 16,00	6,30	71,00	1	25,90	
MBSO87	6,30 x 20,00	8,00	80,00	1	46,51	

BROCAS PARA PONTOS DE SOLDADURA HSS-CO, METAL DURO E TIN

HSS-CO AND TIN DRILLS FOR WELDING SPOTS
FORETS POUR POINTS DE SOUDURE HSS-CO ET TIN

HSS-CO DIN1897

HSS-CO



CÓDIGO	Ø	l mm	L mm	PCS	€
MBSO46	6,00	66	6,00	1	12,88
MBSO47	7,00	74	7,00	1	14,49
MBSO48	8,00	79	8,00	1	15,32
MBSO49	10,00	89	10,00	1	19,50

METAL DURO TIALN



Velocidade de rotação 10 000 rpm

CÓDIGO	Ø	l mm	L mm	PCS	€
MBSO61*	8,00	40	8,00	1	120,53

*Até fim de existência

HSS-CO / 1412E

HSS-CO



CÓDIGO	Ø	l mm	L mm	PCS	€
MBSO50	6,50	40	6,50	1	14,99
MBSO51	8,00	40	8,00	1	17,06
MBSO52	8,00 VARIO	44	8,00	1	17,06

HSS-CO + TIN / 1412E

TIN



CÓDIGO	Ø	l mm	L mm	PCS	€
MBSO53	6,50	40	6,50	1	18,45
MBSO54	8,00	40	8,00	1	21,58
MBSO55	8,00 VARIO	44	8,00	1	21,58

BROCAS COMBINADAS DE CABO HEXAGONAIS 1/4" PARA MÁQUINAS PORTÁTEIS HSS-G

HSS-G COMBINED DRILL BITS WITH 1/4" HEXAGON DRIVE

FORETS COMBINÉS CÂBLE HEXAGONAL 1/4 » POUR MACHINES PORTABLES HSS-G

HSS

Broca + Macho + Escareador



CÓDIGO	Ø	l mm	L mm	1/4"	PCS	€
MTX100	3 × 0,50	2,50	36	1/4	1	9,27
MTX101	4 × 0,70	3,30	39	1/4	1	9,27
MTX102	5 × 0,80	4,20	41	1/4	1	9,27
MTX103	6 × 1,00	5,00	44	1/4	1	9,27
MTX104	8 × 1,25	6,80	50	1/4	1	10,57
MTX105	10 × 1,50	8,50	59	1/4	1	10,57

Jogo de Brocas em Caixa Plástica

CÓDIGO	Ø Medida	€
MTX201	M3-M4-M5-M6-M8-M10 1 Desandador magnético 1/4	65,51

BROCAS DE CABO HEXAGONAIS 1/4" PARA MÁQUINAS PORTÁTEIS HSS-G

HSS-G DRILL BITS WITH 1/4" HEXAGON DRIVE FOR PORTABLE MACHINES

FORETS MÈCHE À 1/4" TIGE HEXAGONALE EN HSS-G POUR MACHINES PORTATIVES

HSS



CÓDIGO	Ø	l mm	L mm	1/4"	PCS	€
MTX001	1,00	7	32	1/4	1	5,71
MTX002	1,50	10	32	1/4	1	5,71
MTX003	2,00	12	34	1/4	1	5,71
MTX004	2,50 (M3)	14	36	1/4	1	5,71
MTX005	3,00	16	38	1/4	1	5,71
MTX006	3,30 (M4)	18	40	1/4	1	5,71
MTX007	3,50	18	40	1/4	1	5,71
MTX008	4,00	20	44	1/4	1	5,71
MTX009	4,20 (M5)	20	45	1/4	1	5,71
MTX010	4,50	24	46	1/4	1	5,71
MTX011	5,00 (M6)	26	50	1/4	1	5,71
MTX012	5,50	26	50	1/4	1	5,92
MTX013	6,00	26	50	1/4	1	5,92
MTX014	6,50	30	50	1/4	1	5,92
MTX015	6,80 (M8)	30	50	1/4	1	5,92
MTX016	7,00	30	50	1/4	1	5,92
MTX017	7,50	32	51	1/4	1	6,98
MTX018	8,00	32	51	1/4	1	6,98
MTX019	8,50 (M10)	33	53	1/4	1	7,97
MTX020	9,00	33	53	1/4	1	7,97
MTX021	9,50	38	54	1/4	1	8,97
MTX022	10,00	38	54	1/4	1	8,97
MTX023	10,20 (M12)	38	54	1/4	1	8,97



Jogo de Brocas em Caixa Plástica

CÓDIGO	Ø Medida	€
MTX200	1-10,5 × 0,5 (19 brocas)	87,83

BURIS REDONDOS E QUADRADOS HSS-CO 10%

HSS-CO 10% ROUND AND SQUARE TURNING BLADES
BURINS RONDS ET CARRÉS HSS-CO 10%

HSS-CO



HSS-CO



Buris Redondos Forma A - DIN4964 - H8 10° CO

CÓDIGO	d mm - L mm	PCS	€
MY0001	3 × 100	1	11,05
MY0002	3 × 150	1	14,00
MY0003	4 × 80	1	9,84
MY0004	4 × 100	1	10,40
MY0005	4 × 150	1	14,45
MY0006	4 × 200	1	18,45
MY0007	5 × 80	1	10,61
MY0008	5 × 100	1	11,95
MY0009	5 × 150	1	16,35
MY0010	5 × 200	1	20,64
MY0011	6 × 80	1	11,60
MY0012	6 × 100	1	14,08
MY0013	6 × 150	1	17,15
MY0014	6 × 200	1	22,40
MY0078	7 × 200	1	31,47
MY0015	8 × 100	1	15,89
MY0016	8 × 150	1	22,80
MY0017	8 × 200	1	29,07
MY0018	10 × 100	1	21,15
MY0019	10 × 150	1	30,93
MY0020	10 × 200	1	36,48
MY0021	12 × 100	1	26,27
MY0022	12 × 150	1	37,73
MY0023	12 × 200	1	43,87
MY0035	14 × 100	1	34,13
MY0024	14 × 150	1	48,53
MY0025	14 × 200	1	58,93
MY0036	16 × 100	1	43,47
MY0026	16 × 150	1	58,64
MY0027	16 × 200	1	79,89
MY0037	16 × 250	1	105,15
MY0028	18 × 150	1	86,16
MY0029	18 × 200	1	88,80
MY0030	20 × 150	1	99,97
MY0031	20 × 200	1	112,27
MY0038	22 × 200	1	141,89
MY0032	25 × 150	1	145,33
MY0033	25 × 200	1	170,00
MY0034	30 × 200	1	253,73

Buris Quadrados Forma B - DIN4964 - 10° CO

CÓDIGO	d mm - B mm - L mm	PCS	€
MY0039	4 × 4 × 80	1	11,88
MY0040	4 × 4 × 100	1	12,93
MY0041	4 × 4 × 150	1	16,40
MY0042	4 × 4 × 200	1	20,13
MY0043	5 × 5 × 80	1	11,98
MY0044	5 × 5 × 100	1	13,31
MY0045	5 × 5 × 150	1	22,93
MY0046	5 × 5 × 200	1	25,33
MY0047	6 × 6 × 80	1	13,20
MY0048	6 × 6 × 100	1	13,61
MY0049	6 × 6 × 150	1	17,33
MY0050	6 × 6 × 200	1	21,31
MY0051	8 × 8 × 100	1	18,80
MY0052	8 × 8 × 150	1	26,53
MY0053	8 × 8 × 200	1	32,67
MY0054	10 × 10 × 100	1	26,00
MY0055	10 × 10 × 150	1	34,13
MY0056	10 × 10 × 200	1	45,60
MY0057	12 × 12 × 100	1	32,67
MY0058	12 × 12 × 150	1	44,80
MY0059	12 × 12 × 200	1	58,64
MY0060	14 × 14 × 100	1	41,31
MY0074	14 × 14 × 150	1	58,40
MY0061	14 × 14 × 200	1	75,20
MY0062	16 × 16 × 150	1	70,80
MY0063	16 × 16 × 200	1	93,31
MY0073	16 × 16 × 250	1	103,94
MY0064	18 × 18 × 150	1	106,13
MY0065	18 × 18 × 200	1	129,20
MY0066	20 × 20 × 150	1	107,87
MY0067	20 × 20 × 200	1	141,20
MY0068	25 × 25 × 150	1	152,53
MY0069	25 × 25 × 200	1	208,67
MY0070	30 × 30 × 200	1	316,37
MY0071	32 × 32 × 200	1	385,81
MY0072	35 × 35 × 200	1	417,58
MY0075	35 × 35 × 250	1	552,10

BURIS REDONDOS EM METAL DURO K10

CARBIDE K10 ROUND TURNING BLADES
BURINS RONDE EN MÉTAL DUR K10

METAL DURO



CÓDIGO	Ø mm	L mm	PCS	€
MY0310	3 x	100	1	11,00
MY0300	4 x	100	1	13,60
MY0309	5 x	100	1	18,00
MY0301	6 x	100	1	25,00
MY0302	8 x	100	1	43,00
MY0303	10 x	100	1	63,20
MY0304	12 x	100	1	87,80
MY0305	14 x	100	1	119,00
MY0306	16 x	100	1	152,80
MY0307	18 x	100	1	s/consulta
MY0308	20 x	100	1	s/consulta

BURIS RETANGULARES - FORMA D - DIN4964 - HSS-CO 10%

HSS-CO 10% RECTANGULAR TURNING BLADES - FORM D - DIN4964
BURINS RECTANGULAIRES HSS-CO 10%

HSS-CO



CÓDIGO	B mm	H mm	L mm	PCS	€
MY0080	8 x	4 x	160	1	28,93
MY0081	8 x	4 x	200	1	34,00
MY0082	8 x	6 x	150	1	34,00
MY0083	8 x	6 x	200	1	39,97
MY0138	10 x	3 x	200	1	31,63
MY0084	10 x	6 x	150	1	34,00
MY0085	10 x	6 x	200	1	39,97
MY0086	10 x	8 x	160	1	52,99
MY0087	10 x	8 x	200	1	62,40
MY0139	12 x	3 x	200	1	33,42
MY0088	12 x	6 x	150	1	39,07
MY0089	12 x	6 x	200	1	47,55
MY0090	12 x	8 x	150	1	54,93
MY0091	12 x	8 x	200	1	63,33
MY0092	12 x	10 x	150	1	63,13
MY0093	12 x	10 x	200	1	72,15
MY0094	14 x	8 x	200	1	81,58
MY0095	14 x	10 x	160	1	79,27
MY0096	14 x	10 x	200	1	108,00
MY0097	14 x	12 x	160	1	93,17
MY0098	14 x	12 x	200	1	102,16
MY0099	15 x	10 x	200	1	113,17
MY0100	16 x	8 x	150	1	68,95
MY0101	16 x	8 x	200	1	78,08
MY0102	16 x	10 x	150	1	80,49
MY0103	16 x	10 x	200	1	88,53
MY0104	16 x	12 x	150	1	90,70
MY0105	16 x	12 x	200	1	101,60
MY0106	18 x	6 x	160	1	56,02
MY0107	18 x	6 x	200	1	60,06
MY0144	18 x	10 x	200	1	94,33

CÓDIGO	B mm	H mm	L mm	PCS	€
MY0137	20 x	5 x	150	1	48,62
MY0108	20 x	8 x	150	1	68,56
MY0109	20 x	8 x	200	1	103,60
MY0110	20 x	10 x	150	1	81,33
MY0111	20 x	10 x	200	1	97,71
MY0112	20 x	12 x	150	1	93,37
MY0113	20 x	12 x	200	1	116,00
MY0114	20 x	16 x	150	1	105,15
MY0115	20 x	16 x	200	1	127,92
MY0116	25 x	10 x	150	1	114,26
MY0117	25 x	10 x	200	1	121,33
MY0118	25 x	12 x	150	1	106,00
MY0119	25 x	12 x	200	1	137,47
MY0120	25 x	16 x	160	1	137,47
MY0121	25 x	16 x	200	1	166,67
MY0122	25 x	20 x	160	1	144,40
MY0123	25 x	20 x	200	1	208,73
MY0141	30 x	10 x	200	1	130,33
MY0124	30 x	12 x	150	1	164,99
MY0125	30 x	12 x	200	1	170,61
MY0126	30 x	20 x	200	1	362,35
MY0127	32 x	16 x	160	1	227,51
MY0128	32 x	16 x	200	1	242,27
MY0132	35 x	12 x	200	1	179,18
MY0129	40 x	10 x	160	1	149,78
MY0130	40 x	10 x	200	1	167,40
MY0131	40 x	12 x	200	1	204,67
MY0133	45 x	12 x	200	1	307,07
MY0135	50 x	10 x	200	1	267,59
MY0134	50 x	12 x	200	1	339,97
MY0136	55 x	12 x	200	1	519,61

LÂMINAS FORMA "L1" HSS-CO 10%

SHAPE "L1" TURNING BLADES

LAMES FORME « L1 » HSS-CO 10%

HSS-CO

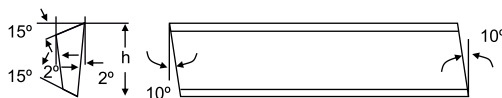

Lâminas Forma "L1" 10° CO

CÓDIGO	B mm	H mm	L mm	PCS	€
MW059	10 x 3	200	1	37,02	
MW034	12 x 3	120	1	20,18	
MW035	12 x 3	160	1	27,48	
MW107	12 x 3,5	200	1	69,45	
MW036	12 x 4	120	1	42,98	
MW037	12 x 4	160	1	43,17	
MW038	12 x 5	120	1	41,50	
MW039	12 x 5	160	1	50,79	
MW100	15 x 3	100	1	27,47	
MW106	15 x 3	200	1	41,33	
MW040	16 x 3	120	1	37,23	
MW041	16 x 3	160	1	41,39	
MW108	16 x 3	200	1	52,52	
MW042	16 x 4	120	1	43,54	
MW043	16 x 4	160	1	47,75	
MW044	16 x 6	120	1	67,45	
MW045	16 x 6	160	1	71,55	
MW110	16 x 8	200	1	87,97	
MW101	17 x 3	125	1	37,02	
MW102	17 x 3,5	125	1	41,66	
MW201	18 x 3	120	1	42,07	
MW109	18 x 3	200	1	45,87	
MW103	18 x 3,5	125	1	83,33	
MW046	18 x 4	120	1	46,84	
MW047	18 x 4	160	1	47,40	
MW057	18 x 4	200	1	52,90	
MW048	19 x 3,5	125	1	32,42	
MW203	20 x 3	100	1	34,12	
MW049	20 x 3	125	1	34,98	
MW050	20 x 3	160	1	41,88	
MW056	20 x 3	200	1	51,75	
MW032	20 x 3,5	125	1	38,50	
MW051	20 x 4	120	1	36,25	
MW052	20 x 4	160	1	44,75	
MW058	20 x 4	200	1	56,25	
MW033	20 x 5	160	1	62,01	
MW202	20 x 5	200	1	103,23	
MW104	22 x 3	120	1	59,75	
MW111	25 x 3	120	1	48,27	
MW112	25 x 4	125	1	58,32	
MW053	25 x 4	150	1	59,18	
MW054	25 x 6	120	1	67,34	
MW055	25 x 6	160	1	88,07	

LÂMINAS FORMA "E" HSS-CO 10%

SHAPE "E" TURNING BLADES

LAMES FORME « E » HSS-CO 10%

HSS-CO

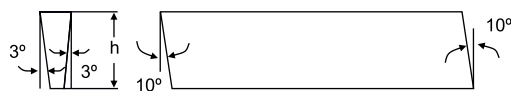

Lâminas Forma "E" - DIN4964 - H8 10° CO

CÓDIGO	B mm	H mm	L mm	PCS	€
MW001	12 x 3	100	1	22,50	
MW002	12 x 3	160	1	28,12	
MW003	12 x 3	200	1	33,77	
MW004	12 x 5	100	1	28,43	
MW005	12 x 5	160	1	33,94	
MW006	12 x 5	200	1	54,91	
MW007	16 x 4	100	1	31,00	
MW008	16 x 4	160	1	46,00	
MW009	16 x 4	200	1	50,75	
MW010	18 x 3	100	1	24,50	
MW011	18 x 3	160	1	41,50	
MW012	18 x 3	200	1	50,75	
MW013	18 x 4	100	1	36,87	
MW014	18 x 4	150	1	45,75	
MW015	18 x 4	200	1	55,62	
MW016	18 x 6	100	1	35,28	
MW017	18 x 6	160	1	62,98	
MW018	18 x 6	200	1	68,60	
MW019	20 x 3	100	1	26,40	
MW020	20 x 3	150	1	39,87	
MW021	20 x 3	200	1	51,00	
MW022	20 x 4	100	1	29,95	
MW023	20 x 4	160	1	51,37	
MW024	20 x 4	200	1	57,37	
MW025	20 x 5	100	1	45,49	
MW026	20 x 5	160	1	58,50	
MW027	20 x 5	200	1	69,02	
MW200	22 x 4	120	1	44,75	
MW028	25 x 6	100	1	85,14	
MW029	25 x 6	160	1	88,88	
MW030	25 x 6	200	1	98,50	

SUPORE PARA LÂMINA SANGRAR

BLADE SUPPORT

SUPPORT DE LAME



CÓDIGO	medida	PCS	€
MWS01	12 mm	1	96,10
MWS02	16 mm	1	110,51
MWS03	20 mm	1	123,73

DISCOS ABRASIVOS DE CORTE E REBARBAR **TOP LINE**

CUTTING AND GRINDING ABRASIVE DISCS TOP LINE

DISQUES ABRASIFS DE COUPE ET DE MEULAGE TOP LINE

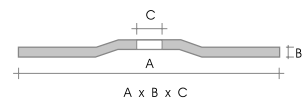

Corte de Ferro

CÓDIGO	A	x	B	x	C	R. P. M. Velocidade Máxima	PCS	€*
MDT002	115	x	3	x	22	13000	50	0,60
MDT003	125	x	3	x	22	12000	50	0,68
MDT004	180	x	3,2	x	22	8500	25	1,40
MDT005	230	x	3,2	x	22	6500	25	2,00
MDT006	300	x	3,2	x	25,4	5000	25	4,19
MDT007	350	x	3,2	x	25,4	4000	25	5,11

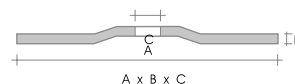

Rebarbar

CÓDIGO	A	x	B	x	C	R. P. M. Velocidade Máxima	PCS	€*
MDT021	115	x	6	x	22	13000	50	1,13
MDT022	125	x	6	x	22	12000	50	1,30
MDT023	150	x	6	x	22	10000	50	1,94
MDT024	180	x	7	x	22	8500	25	2,34
MDT025	230	x	6	x	22	6500	25	3,43



Corte de Inox

CÓDIGO	A	x	B	x	C	R. P. M. Velocidade Máxima	PCS	€*
MDT030	115	x	1	x	22	13000	50	0,50
MDT031	115	x	1,6	x	22	13000	50	0,55
MDT032	115	x	2	x	22	13000	50	0,60
MDT033	115	x	3	x	22	13000	50	0,72
MDT034	125	x	1	x	22	12000	50	0,55
MDT035	125	x	1,2	x	22	12000	50	0,55
MDT036	125	x	1,6	x	22	12000	50	0,60
MDT037	125	x	3	x	22	12000	50	0,85
MDT038	180	x	1,6	x	22	8500	50	1,28
MDT039	180	x	2	x	22	8500	25	1,30
MDT040	180	x	3	x	22	8500	25	1,45
MDT041	230	x	2	x	22	6500	25	1,90
MDT042	230	x	3	x	22	6500	25	2,10

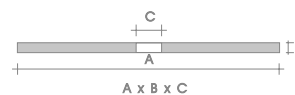

*Preço por Unidade

DISCOS ABRASIVOS DE CORTE E REBARBAR PREMIUM

CUTTING AND GRINDING ABRASIVE DISCS PREMIUM

DISQUES ABRASIFS DE COUPE ET DE MEULAGE PREMIUM

Corte de Ferro

CÓDIGO	A	x	B	x	C	R. P. M. Velocidade Máxima	PCS	€*
MD002	115	x	3	x	22	13000	50	1,17
MD003	125	x	3	x	22	12000	50	1,25
MD004	180	x	3,2	x	22	8500	25	1,76
MD005	230	x	3,2	x	22	6600	25	2,61
MD006	300	x	3,2	x	25,4	5000	25	4,61
MD008	300	x	3,2	x	30	5000	25	4,61
MD007	350	x	3,5	x	25,4	4000	10	7,41
MD009	350	x	3,5	x	30	4000	10	7,41

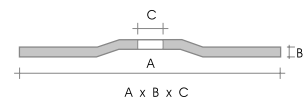

Corte de Pedra

CÓDIGO	A	x	B	x	C	R. P. M. Velocidade Máxima	PCS	€*
MD011	115	x	3	x	22	13000	50	1,23
MD012	125	x	3	x	22	12000	50	1,39
MD013	180	x	3,2	x	22	8500	25	1,89
MD014	230	x	3,2	x	22	6600	25	2,75
MD015	300	x	3,2	x	25,4	5000	25	4,77
MD016	300	x	3,2	x	30	5000	25	4,77

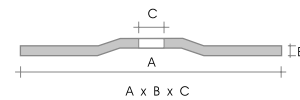

Rebarbar

CÓDIGO	A	x	B	x	C	R. P. M. Velocidade Máxima	PCS	€*
MD021	115	x	6	x	22	13000	50	1,60
MD022	125	x	6	x	22	12000	50	1,84
MD042	150	x	6	x	22	10000	50	2,35
MD023	180	x	7	x	22	8500	25	2,61
MD025	230	x	6	x	22	5000	25	3,95

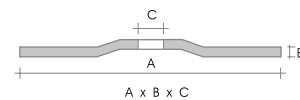

Corte de Inox

CÓDIGO	A	x	B	x	C	R. P. M. Velocidade Máxima	PCS	€*
MD030	115	x	1	x	22	13000	50	1,12
MD031	115	x	1,6	x	22	13000	50	1,20
MD032	115	x	2	x	22	13000	50	1,39
MD033	115	x	3	x	22	13000	50	1,39
MD040	125	x	1	x	22	12000	50	1,31
MD043	125	x	1,2	x	22	12000	50	1,55
MD034	125	x	1,6	x	22	12000	50	1,47
MD035	125	x	3	x	22	12000	50	1,52
MD041	180	x	1,6	x	22	8500	50	2,08
MD036	180	x	2	x	22	8500	25	1,89
MD037	180	x	3	x	22	8500	25	2,00
MD038	230	x	2	x	22	6600	25	2,80
MD039	230	x	3	x	22	6600	25	2,91

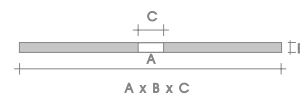

DISCOS ABRASIVOS DE REBARBAR E POLIR PARA INOX

GRINDING AND POLISHING ABRASIVE DISCS FOR STAINLESS STEEL

DISQUES ABRASIFS D'ÉBAVURAGE ET DE POLISSAGE POUR L'ACIER INOXYDABLE

Rebarbar Inox

CÓDIGO	A	x	B	x	C	R. P. M. Velocidade Máxima	PCS	€*
MD050	115	x	6	x	22	13300	50	1,89
MD051	125	x	6	x	22	12250	50	2,08
MD052	180	x	7	x	22	8500	25	2,96
MD053	230	x	6	x	22	6650	25	4,77

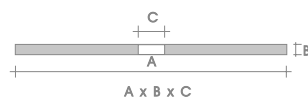
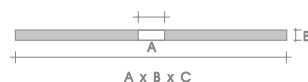

Disco Compresso

CÓDIGO	A	x	B	x	C	Grão	R. P. M. Velocidade Máxima	PCS	€*	
MD110	SL-2SF	115	x	12,5	x	22	2	11000	10	30,24
MD111	CA-3SF	115	x	12,5	x	22	3	11000	10	36,40



115 - SL Peças Lisas 115

115 - CA Peças com ângulo

Disco especial para rebarbar, polir, acabamento, remove imperfeições em todo o tipo de metais (inox, aço, titânio, alumínio, madeira e material plástico).

Polimento e rectificação da soldadura: os discos compressos para inox estão preparados para um excelente acabamento de superfícies e arranque de material, assim como peças angulares e ranhuras de difícil acesso.



*Preço por Unidade

LAMELAS

FLAP DISCS

DISQUES À LAMELLES

Master Line Zircónio - Linha Económica

CÓDIGO	A	x	C	Grão	R. P. M. Velocidade Máxima	PCS	€*
MDLAM001	115	x	22	40	10500	10	2,65
MDLAM002	115	x	22	60	10500	10	2,65
MDLAM003	115	x	22	80	10500	10	2,65
MDLAM004	115	x	22	120	10500	10	2,65
MDLAM010	125	x	22	40	9650	10	3,15
MDLAM011	125	x	22	60	9650	10	3,15
MDLAM012	125	x	22	80	9650	10	3,15
MDLAM013	125	x	22	120	9650	10	3,15

Restantes medidas sob consulta

- Ideal para aplicações em aço, madeira e metais não ferrosos.
- Corte rápido e ótimo desempenho na remoção do material.



Master Top Line Zircónio - Gama Alta

CÓDIGO	A	x	C	Grão	R. P. M. Velocidade Máxima	PCS	€*
MDLAM101	115	x	22	40	10500	10	3,51
MDLAM102	115	x	22	60	10500	10	3,51
MDLAM103	115	x	22	80	10500	10	3,51
MDLAM104	115	x	22	120	10500	10	3,51
MDLAM110	125	x	22	40	9650	10	3,78
MDLAM111	125	x	22	60	9650	10	3,78
MDLAM112	125	x	22	80	9650	10	3,78
MDLAM113	125	x	22	120	9650	10	3,78

Restantes medidas sob consulta

- Produto versátil para retificar e desbastar em aço e inox.
- Rendimento constante e duradouro.
- Baixa vibração e ruído.



Master Cerâmico (Lâmina Dupla)

CÓDIGO	A	x	C	Grão	R. P. M. Velocidade Máxima	PCS	€*
MDLAM201	115	x	22	40	10500	10	4,73
MDLAM202	115	x	22	60	10500	10	4,73
MDLAM210	125	x	22	40	9650	10	5,15
MDLAM211	125	x	22	60	9650	10	5,15

Restantes medidas sob consulta

- Excelente desempenho em aços forjados e liga de aço.
- Longa durabilidade.



Master Alumínio

CÓDIGO	A	x	C	Grão	R. P. M. Velocidade Máxima	PCS	€*
MDLAM220	115	x	22	40	10500	10	4,82
MDLAM221	115	x	22	60	10500	10	4,82
MDLAM222	115	x	22	80	10500	10	4,82

- Permite trabalhar o alumínio com excelente desempenho.
- Ideal para aplicações em cobre, zinco, titânio, cobalto, madeira e materiais compostos como fibra de carbono.



*Preço por Unidade

LAMELAS, FOLHAS DE ESFREGÃO E ROLOS DE ESFREGÃO

FLAP DISCS, MOP SHEETS AND MOP ROLLERS
LAMELLES, FEUILLES DE MOP ET ROULEAUX DE MOP

Suporte em Fibra de Vidro para Inox

CÓDIGO	A	x	C	Grão	Furo	PCS	€*
MDLAM123	115	x	22	Fino	20	10	13,87

- Discos de lamela em tecido não tecido.

TNT



Suporte em Fibra de Vidro para Inox Mista

CÓDIGO	A	x	C	Grão	Furo	PCS	€*
MDLAM124	115	x	22	Médio	20	10	15,68

- Discos de lamela mistos em tela abrasiva e tecido não tecido.

TNT
TELA



Folhas de Esfregão

CÓDIGO	Dimensão	Tipo	PCS	€*
MD120	115 x 280	Muito Fino / Vermelho	10	1,47
MD121	115 x 280	Ultra fino / Cinza	10	1,47
MD119	120 x 280	Ultra Fino / Verde	10	1,47

Vermelho (Muito fino)

- Uso geral para limpeza de metais e plásticos (silicato de alumínio).

Cinza (Ultra fino)

- Uso geral (carbureto de silício).

Verde (Ultra Fino)

- Uso geral (carbureto de silício).



Rolos de Esfregão

CÓDIGO	Dimensão	Tipo	PCS	€*
MD122	115 x 10 mts	Muito Fino / Vermelho	1	44,80
MD123	115 x 10 mts	Ultra Fino / Cinza	1	44,80
MD124	115 x 10 mts	Ultra Fino / Verde	1	44,80

Vermelho (Muito fino)

- Uso geral para limpeza de metais e plásticos (carbureto de silício).

Cinza (Ultra Fino)

- Uso geral (carbureto de silício).

Verde (Ultra Fino)

- Uso geral (carbureto de silício).



*Preço por Unidade

LAMELAS E ESFREGÕES - ESPECIAL GRÉS

LAMELLAR DIAMOND GRINDING WHEEL, DIAMOND POLISHING PAD
ROUE À LAMELLES DE MEULAGE DIAMANTÉE, TAMPON DE POLISSAGE DIAMANTÉ

Lamelas Especial Grés

(Grés, Grés Porcelânico, Grés Esmaltado, Pedra)

NOVO

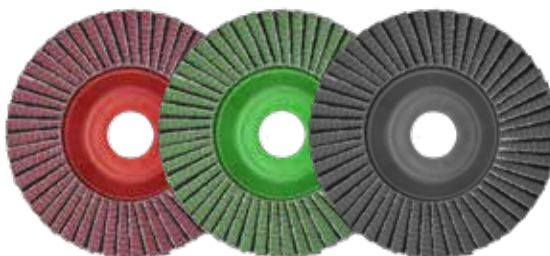

CÓDIGO	Grão	Furo	Ø	€
MDGL01	60	22,23	115	67,47
MDGL02	120	22,23	115	67,47
MDGL03	200	22,23	115	67,47

Esfregões Abrasivos Multimaterial

(Azulejos, Mármore, Cerâmica, Vidro e Fibra de Vidro)

NOVO



CÓDIGO	Grão	Cor	€
MDE01	60	●	19,47
MDE02	100	●	18,13
MDE03	200	●	14,93
MDE04	400	●	14,93
MDE05	800	●	14,93
MDE06	1500	●	14,93
MDE07	3000	●	14,93

ESCAREADORES HSS-CO E TITÂNIO

HSS-CO AND TIN COATED COUNTERSINKS
ALÉSOIRS HSS-CO ET EN TITANE

Escareadores de 3 Canais, Ângulo 90° em HSS-CO - DIN335C

CÓDIGO	Ø Nominal	Capacidade Mínima	Capacidade Máxima	Comp.	Cabo	PCS	€
ESCO01	4,30	1,30	- 4,00	40	4	1	8,16
ESCO02	5,30	1,50	- 4,80	40	4	1	8,16
ESCO03	6,30	1,50	- 5,80	45	5	1	8,42
ESCO04	7,30	1,80	- 6,80	50	6	1	9,32
ESCO05	8,30	2,00	- 7,80	50	6	1	9,54
ESCO06	9,40	2,20	- 8,90	50	6	1	10,46
ESCO07	10,40	3,00	- 9,70	50	6	1	11,50
ESCO08	12,40	3,20	- 12,00	56	8	1	12,41
ESCO09	15,00	3,50	- 15,00	60	10	1	14,24
ESCO10	16,50	3,60	- 16,00	60	10	1	15,19
ESCO15	19,00	3,50	- 19,00	63	10	1	17,76
ESCO11	20,50	3,50	- 20,00	63	10	1	20,92
ESCO16	23,00	3,80	- 23,00	67	10	1	22,90
ESCO12	25,00	4,50	- 24,00	67	10	1	32,12
ESCO13	28,00	4,00	- 27,50	71	12	1	37,17
ESCO14	31,00	5,00	- 30,00	71	12	1	40,61



Jogo em Caixa Metálica	
Composição 6 UNDS	
Ø	UN
6,30	1
8,30	1
10,40	1
12,40	1
16,50	1
20,50	1
CÓDIGO	€
ESJ001	77,99

Escareadores de 3 Canais, Ângulo 90° em HSS-CO / Titânio - DIN335C

CÓDIGO	Ø Nominal	Capacidade Mínima	Capacidade Máxima	Comp.	Cabo	PCS	€
ESTI01	4,30	1,30	- 4,00	40	4	1	12,84
ESTI02	5,30	1,50	- 4,80	40	4	1	12,84
ESTI03	6,30	1,50	- 5,80	45	5	1	13,02
ESTI04	7,30	1,80	- 6,80	50	6	1	15,02
ESTI05	8,30	2,00	- 7,80	50	6	1	15,28
ESTI06	9,40	2,20	- 8,90	50	6	1	16,17
ESTI07	10,40	3,00	- 9,70	50	6	1	17,26
ESTI08	12,40	3,20	- 12,00	56	8	1	18,74
ESTI09	15,00	3,50	- 15,00	60	10	1	21,48
ESTI10	16,50	3,60	- 16,00	60	10	1	22,51
ESTI15	19,00	3,50	- 19,00	63	10	1	26,32
ESTI11	20,50	3,50	- 20,00	63	10	1	31,00
ESTI16	23,00	3,80	- 23,00	67	10	1	37,63
ESTI12	25,00	4,50	- 24,00	67	10	1	43,92
ESTI13	28,00	4,00	- 27,50	71	12	1	48,44
ESTI14	31,00	5,00	- 30,00	71	12	1	59,45



Jogo em Caixa Metálica	
Composição 6 UNDS	
Ø	UN
6,30	1
8,30	1
10,40	1
12,40	1
16,50	1
20,50	1
CÓDIGO	€
ESJT01	117,82

Escareadores com Furo, Ângulo de 90° em HSS-CO

CÓDIGO	Ø Nominal	Capacidade Mínima	Capacidade Máxima	Comp.	Cabo	PCS	€
ESCF01	10,00	2,00	- 5,00	45	6	1	11,17
ESCF02	14,00	5,00	- 10,00	48	8	1	12,55
ESCF03	20,00	10,00	- 15,00	65	10	1	24,70
ESCF04	27,00	15,00	- 20,00	86	12	1	43,76
ESCF05	30,00	20,00	- 25,00	102	15	1	79,98
ESCF06	35,00	25,00	- 30,00	115	15	1	118,15
ESCF07	40,00	30,00	- 35,00	127	15	1	173,59
ESCF08	45,00	35,00	- 40,00	136	15	1	244,70
ESCF09	50,00	40,00	- 50,00	166	20	1	300,17



Jogo em Caixa Metálica	
Composição 4 UNDS	
Ø	UN
2 - 5	1
5 - 10	1
10 - 15	1
15 - 20	1
CÓDIGO	€
ESCFJ01	92,19

ESCAREADORES 90° TOPLINE HSS-CO E HSS-TIN

HSS-CO AND HSS-TIN 90° TOPLINE COUNTERSINKS
ALÉSOIRS 90° TOPLINE HSS-CO ET HSS-TIN

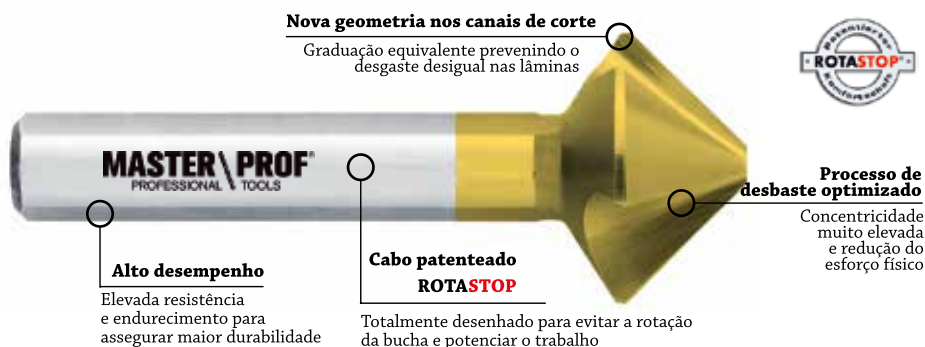

Vantagens

- + 50% de durabilidade
- + 25% de rapidez
- + facilidade na realização do trabalho
- + melhor acabamento



Escareadores de 3 Canais, Ângulo 90° em HSS-CO - DIN335C

CÓDIGO						PCS	€
ESTOP50	6,30	45	5	1,5	M 3	1	15,59
ESTOP51	8,30	50	6	2,0	M 4	1	19,59
ESTOP52	10,40	50	6	2,5	M 5	1	20,25
ESTOP53	12,40	56	8	2,8	M 6	1	22,56
ESTOP54	15,00	60	10	3,2	M 8	1	29,54
ESTOP55	16,50	60	10	3,2	M 8	1	30,23
ESTOP56	19,00	63	10	3,5	M 10	1	31,92
ESTOP57	20,50	63	10	3,5	M 10	1	32,71
ESTOP58	23,00	67	10	3,8	M 12	1	34,31
ESTOP59	25,00	67	10	3,8	M 12	1	39,82
ESTOP60	31,00	71	12	4,2	M 16	1	44,32



HSS-TIN

CÓDIGO						PCS	€
ESTOP01	6,30	45	5	1,5	M 3	1	17,01
ESTOP02	8,30	50	6	2,0	M 4	1	21,36
ESTOP03	10,40	50	6	2,5	M 5	1	22,09
ESTOP04	12,40	56	8	2,8	M 6	1	24,60
ESTOP05	15,00	60	10	3,2	M 8	1	32,21
ESTOP06	16,50	60	10	3,2	M 8	1	32,97
ESTOP07	19,00	63	10	3,5	M 10	1	34,80
ESTOP08	20,50	63	10	3,5	M 10	1	35,67
ESTOP09	23,00	67	10	3,8	M 12	1	37,41
ESTOP10	25,00	67	10	3,8	M 12	1	38,16
ESTOP11	31,00	71	12	4,2	M 16	1	41,13

JOGOS DE ESCAREADORES 90° TOPLINE HSS-CO E HSS-TIN

HSS-CO AND HSS-TIN 90° TOPLINE COUNTERSINKS SETS
JEUX ALÉSOIRS 90° TOPLINE HSS-CO ET HSS-TIN

HSS-CO



Jogo em HSS-CO Caixa Plástica

Composição 6 unidades

Ø	UN
6,30	1
8,30	1
10,40	1
12,40	1
16,50	1
20,50	1

CÓDIGO	€
ESTOP70	140,93

Composição 5 unidades

Ø	UN
6,30	1
10,40	1
16,50	1
20,50	1
25,00	1

CÓDIGO	€
ESTOP71	135,48

TIN



Jogo em HSS-TIN Caixa Plástica

Composição 6 unidades

Ø	UN
6,30	1
8,30	1
10,40	1
12,40	1
16,50	1
20,50	1

CÓDIGO	€
ESTOP30	153,69

Composição 5 unidades

Ø	UN
6,30	1
10,40	1
16,50	1
20,50	1
25,00	1

CÓDIGO	€
ESTOP31	145,13

Com cabo patenteado ROTASTOP® DIN335-C

Devido ao processo de retificação otimizado, a nova geração de escareadores da **MASTER PROF**, garante um processo de corte até 25% mais rápido com uma otimização de vida útil de aproximadamente 50%. O cabo ROTASTOP® (patenteado) foi totalmente desenhado para evitar a rotação na bucha e potencializar o trabalho. Com este escareador garante os melhores resultados, processos de corte mais rápidos e reduz os custos nas aplicações.

ESCAREADORES DE 90° CABO HEXAGONAL HSS E ANTIVIBRAÇÃO HSS-CO

HSS AND HSS-CO 8% COUNTERSINKS ANTIVIBRATION HEXAGONAL HANDLE
ALÉSOIRS 90° CÂBLE HEXAGONALE HSS ET ANTI-VIBRATION HSS-CO

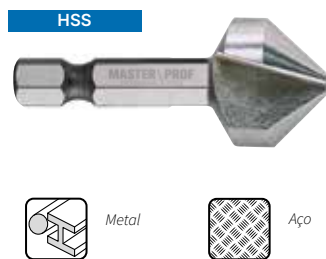

Metal



Aço

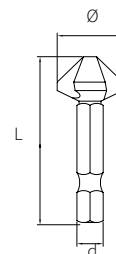

Escareador de Cabo Hexagonal 1/4 - E6.3

CÓDIGO	Ø	L	D	d	€
ESCO80	6,3	40	1/4	M 3	8,20
ESCO81	8,3	45	1/4	M 4	9,02
ESCO82	10,4	47	1/4	M 5	10,22
ESCO83	12,4	49	1/4	M 6	12,34
ESCO84	16,5	52	1/4	M 8	13,32
ESCO85	20,5	55	1/4	M 10	18,30

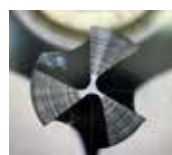
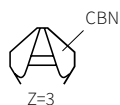

Escareador Antivibração 3Z com Hélice Alternada HSS-CO

CÓDIGO	Ø	L	D-	d	€
ESCOA01	6,3	45	1,5	5	16,20
ESCOA02	8,3	50	2	6	17,10
ESCOA03	10,4	50	2,5	6	21,10
ESCOA04	12,4	56	2,80	8	22,56
ESCOA05	15,0	60	3,20	10	28,30
ESCOA06	16,5	60	3,20	10	30,23
ESCOA07	20,5	63	3,50	10	31,80
ESCOA08	25,0	67	3,80	10	33,20
ESCOA09	31,00	71	4,20	12	38,10



FRESAS ESCALONADAS EM HSS E TIN

STEP DRILLS
FRAISE-ESCALIERS

HSS



HSS-G para Furos em Chapa e Tubo

CÓDIGO	Ø Medida Min.	Ø Medida Max.	Ø Progres. Degraus	Nº Degraus	Comp. Total	Ø Cabo	PCS	€
MFE02	4	a 12	1	9	72	6	1	16,15
MFE04	4	a 20	2	9	85	10	1	21,74
MFE06	4	a 30	2	13	97	10	1	45,90
MFE10	5	a 38	1	14	95	12	1	56,32
MFE09	6	a 40	1	16	105	13	1	58,56
MFE08	40	a 50	1	11	100	13	1	139,60



Caixa Plástica	
Composição 3 Peças	
Ø Medida Min. / Max.	UN
4 a 12	1
4 a 20	1
4 a 30	1
CÓDIGO	€
MFBE10	83,81

HSS

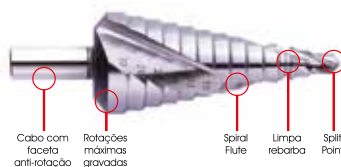

Helicoidais HSS-G

CÓDIGO	Ø Medida Min.	Ø Medida Max.	Ø Progres. Degraus	Nº Degraus	Comp. Total	Ø Cabo	PCS	€
MFE40	4	a 12	1	5	80	6	1	24,06
MFE41	4	a 20	2	4	67	8	1	32,37
MFE42	6	a 30	2	4	98	10	1	51,92
MFE43	6	a 36	3	3	82	12	1	58,89



Caixa Plástica	
Composição 3 UNDS	
Ø Medida Min. / Max.	UN
4 a 12	1
4 a 20	1
6 a 30	1
CÓDIGO	€
MFE49	108,36

TIN



HSS-G Revestida a Titânio para Furar Inox e Aço Tratado

CÓDIGO	Ø Medida Min.	Ø Medida Max.	Ø Progres. Degraus	Nº Degraus	Comp. Total	Ø Cabo	PCS	€
MFET02	4	a 12	1	9	72	6	1	25,25
MFET04	4	a 20	2	9	85	10	1	41,31
MFET06	4	a 30	2	13	97	10	1	81,98
MFET09	6	a 40	1	16	105	13	1	103,38



Caixa Plástica	
Composição 3 Peças	
Ø Medida Min. / Max.	UN
4 a 12	1
4 a 20	1
4 a 30	1
CÓDIGO	€
MFBEET6	148,43

TIALN



Helicoidais HSS-G + TIALN para Inox

CÓDIGO	Ø Medida Min.	Ø Medida Max.	Ø Progres. Degraus	Nº Degraus	Comp. Total	Ø Cabo	PCS	€
MFE60	4	a 12	1	5	80	6	1	29,89
MFE61	4	a 20	2	4	67	8	1	34,66
MFE62	6	a 30	2	4	98	10	1	64,48
MFE63	6	a 36	3	3	82	12	1	73,13



Caixa Plástica	
Composição 3 Peças	
Ø Medida Min. / Max.	UN
4 a 12	1
4 a 20	1
6 a 30	1
CÓDIGO	€
MFE69	129,35

FRESAS ESCALONADAS HSS COM CABO HEXAGONAL 1/4 - E6.3

HSS STEP DRILLS WITH HEXAGONAL CABLE
FRAISE-ESCALIERS AVEC CÂBLE HEXAGONALE HSS



ENCAIXE RÁPIDO

ENCAIXE RÁPIDO



Metal



Aço

R ≤ 800 N/mm²



Metal



Aço

R ≤ 800 N/mm²

Fresa Escalonada Helicoidal HEX 1/4

CÓDIGO	Ø	Prog. Degraus	Nº Degraus	Comp. Total	Cabo	€
MFE80	4 a 12	1	8	80	1/4	12,77
MFE81	4 a 20	2	9	76	1/4	17,80
MFE82	6 a 30	2	12	100	1/4	36,67

Fresa Escalonada Direita HEX 1/4

CÓDIGO	Ø	Prog. Degraus	Nº Degraus	Comp. Total	Cabo	€
MFE90	4 a 12	1	9	68	1/4	17,86
MFE91	4 a 20	2	9	78	1/4	44,24
MFE92	6 a 30	2	13	101	1/4	53,84

HSS



JOGOS DE FRESAS ESCALONADAS HELICOIDAIS HEX 1/4

Composição 3 Peças

- 1 x 4 a 12 mm
- 1 x 4 a 20 mm
- 1 x 6 a 30 mm

CÓDIGO	€
MFE89	96,35

HSS



JOGOS DE FRESAS ESCALONADAS DIREITAS HEX 1/4

Composição 3 Peças

- 1 x 4 a 12 mm
- 1 x 4 a 20 mm
- 1 x 6 a 30 mm

CÓDIGO	€
MFE93	94,66

FRESAS FRONTAIS DE 1 NAVALHA P/ ALUMÍNIO SÉRIE CURTA E LONGA HSS

ALUMINIUM 1Z HSS FINISHING END MILLS

FRAISES FRONTALES À 1 COUPEAU POUR ALUMINIUM SÉRIE COURTE ET LONGUE HSS



Série Curta - Encabadouro ø 8mm

CÓDIGO	Ø	Ød mm	L mm	l mm	PCS	€
PROF441201	3	8	60	12	1	11,63
PROF441202	4	8	60	12	1	11,63
PROF441203	5	8	60	12	1	11,63
PROF441204	6	8	60	14	1	11,63
PROF441205	7	8	60	14	1	14,24
PROF441206	8	8	80	15	1	14,24
PROF441207	10	10	80	15	1	14,64

Série Curta - Encabadouro ø 6mm

CÓDIGO	Ø	Ød mm	L mm	l mm	PCS	€
PROF441301	3	6	60	12	1	11,63
PROF441302	4	6	60	12	1	11,63
PROF441303	5	6	60	12	1	11,63
PROF441304	6	6	60	14	1	11,63



Série Longa - Encabadouro ø 8mm

CÓDIGO	Ø	Ød mm	L mm	l mm	Y mm	PCS	€
PROF441401	4	8	80	16	29	1	16,47
PROF441402	5	8	80	16	29	1	16,47
PROF441403	6	8	90	16	29	1	16,47
PROF441404	8	8	100	28	40	1	18,28

Série Longa - Encabadouro ø 6mm

CÓDIGO	Ø	Ød mm	L mm	l mm	Y mm	PCS	€
PROF441501	5	6	80	14	31	1	16,47
PROF441502	6	6	80	14	31	1	16,47

FRESAS FRONTAIS DE 1 NAV. P/ ALUMÍNIO SÉRIE CURTA E LONGA METAL DURO

ALUMINIUM 1Z HSS FINISHING END MILLS

FRAISES FRONTALES À 1 COUPEAU POUR ALUMINIUM SÉRIE COURTE ET LONGUE MÉTAL DUR



Série Curta (Recomendado a Termoplásticos)

CÓDIGO	Ø	Ød mm	L mm	l mm	PCS	€
PROF941101	3,00	3	38	12	1	17,18
PROF941102	4,00	4	40	12	1	20,91
PROF941103	5,00	5	50	12	1	25,85
PROF941104	6,00	6	50	14	1	30,70
PROF941105	8,00	8	63	15	1	46,60
PROF941106	10,00	10	72	15	1	65,14



Série Longa (Recomendado a Alumínio)

CÓDIGO	Ø	Ød mm	L mm	l mm	PCS	€
PROF941401	4,00	8	80	16	1	73,39
PROF941402	5,00	8	80	16	1	73,39
PROF941403	6,00	8	90	16	1	73,39
PROF941404	8,00	8	100	28	1	95,72
PROF941405	10,00	10	120	40	1	123,79

FRESAS FRONTAIS 1 NAV. POLIDAS TIPO ESPELHO P/ ALUMÍNIO EM METAL DURO

1Z MIRROR POLISHED END MILLS

FRAISES FRONTALES 1 NAV. POLI MIROIR POUR L'ALUMINIUM MÉTAL DUR



Série Curta

CÓDIGO	Ø	Ød mm	L mm	l mm	PCS	€
PROF941601	1,00	3	38	5	1	10,73
PROF941602	1,50	3	38	6	1	10,73
PROF941603	2,00	3	38	6	1	10,73
PROF941604	2,50	3	38	6	1	10,73
PROF941605	3,00	3	38	12	1	16,70
PROF941606	4,00	4	45	15	1	20,34
PROF941607	5,00	5	50	16	1	25,15
PROF941608	6,00	6	50	17	1	29,86
PROF941609	8,00	8	60	22	1	45,34
PROF941610	10,00	10	75	32	1	64,38
PROF941611	12,00	12	75	35	1	96,60



Série Longa

CÓDIGO	Ø	Ød mm	L mm	l mm	PCS	€
PROF941701	3,00	3	70	42	1	31,98
PROF941702	4,00	4	70	42	1	39,59
PROF941703	5,00	5	80	42	1	47,44
PROF941704	6,00	6	85	52	1	62,09
PROF941705	8,00	8	90	52	1	90,14
PROF941706	10,00	10	100	52	1	124,00
PROF941707	12,00	12	100	55	1	163,29

Características:

- Canal especial polido tipo espelho;
- Melhora o rendimento em perfis de alumínio e duroplásticos;
- Geometria melhorada para um alto rendimento.

FRESAS FRONTAIS 2 NAVALHAS CABO CILÍNDRICO HSS-CO 8% E TIALSIN

2Z HSS-CO 8% FINISHING END MILLS

FRAISES FRONTAUX 2 COUTEAUX CÂBLE CYLINDRIQUE HSSE 8% ET TIALNIN

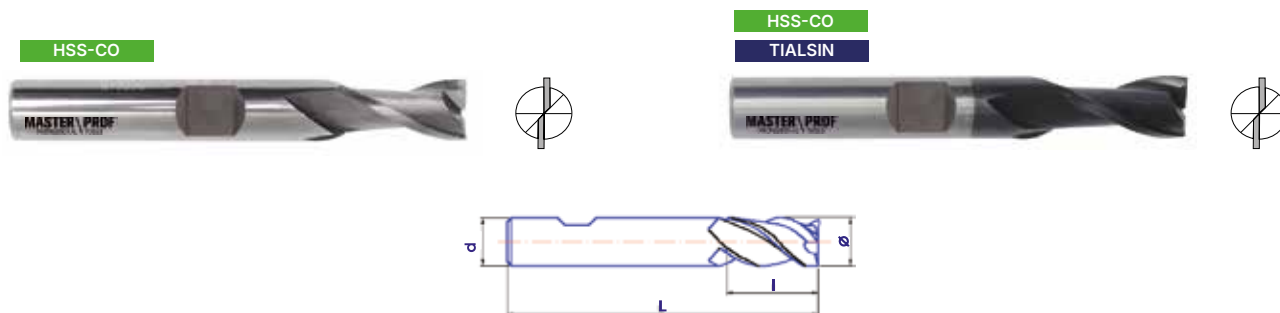

HSSE 8% Co

CÓDIGO	Ø	d mm	L mm	l mm	PCS	€
PROF442001	2,00	6	48	4	1	11,33
PROF442002	2,50	6	49	5	1	11,33
PROF442003	3,00	6	49	5	1	11,33
PROF442004	3,50	6	50	6	1	12,35
PROF442005	4,00	6	51	7	1	11,33
PROF442006	4,50	6	52	8	1	13,58
PROF442007	5,00	6	52	8	1	11,33
PROF442008	5,50	6	52	8	1	13,96
PROF442009	6,00	6	52	8	1	11,33
PROF442010	6,50	10	60	10	1	18,24
PROF442011	7,00	10	60	10	1	17,72
PROF442012	7,50	10	61	11	1	17,56
PROF442013	8,00	10	61	11	1	14,59
PROF442014	8,50	10	61	11	1	19,73
PROF442015	9,00	10	61	11	1	18,14
PROF442016	9,50	10	61	11	1	19,29
PROF442017	10,00	10	63	13	1	14,51
PROF442018	11,00	12	70	13	1	22,17
PROF442019	12,00	12	73	16	1	19,42
PROF442020	13,00	12	73	16	1	28,56
PROF442021	14,00	12	73	16	1	28,56
PROF442022	15,00	12	73	16	1	31,94
PROF442023	16,00	16	79	19	1	28,10
PROF442024	17,00	16	79	19	1	38,00
PROF442025	18,00	16	79	19	1	38,00
PROF442026	19,00	16	79	19	1	47,96
PROF442027	20,00	20	88	22	1	45,38
PROF442028	22,00	20	88	22	1	59,37
PROF442029	24,00	25	102	26	1	79,48
PROF442030	25,00	25	102	26	1	75,20
PROF442031	28,00	25	102	26	1	95,18
PROF442032	30,00	25	102	26	1	108,46
PROF442033	32,00	32	112	32	1	111,39
PROF442034	36,00	32	112	32	1	149,01
PROF442035	40,00	40	130	48	1	182,94

TIALSIN

CÓDIGO	Ø	d mm	L mm	l mm	PCS	€
PROF442036	2,00	6	48	4	1	18,50
PROF442037	2,50	6	49	5	1	18,50
PROF442038	3,00	6	49	5	1	18,50
PROF442039	3,50	6	50	6	1	19,48
PROF442040	4,00	6	51	7	1	18,50
PROF442041	4,50	6	52	8	1	20,68
PROF442042	5,00	6	52	8	1	18,50
PROF442043	5,50	6	52	8	1	21,05
PROF442044	6,00	6	52	8	1	18,50
PROF442045	6,50	10	60	10	1	28,16
PROF442046	7,00	10	60	10	1	27,81
PROF442047	7,50	10	61	11	1	27,70
PROF442048	8,00	10	61	11	1	25,80
PROF442049	8,50	10	61	11	1	29,11
PROF442050	9,00	10	61	11	1	28,08
PROF442051	9,50	10	61	11	1	28,84
PROF442052	10,00	10	63	13	1	25,72
PROF442053	11,00	12	70	13	1	32,15
PROF442054	12,00	12	73	16	1	29,91
PROF442055	13,00	12	73	16	1	39,73
PROF442056	14,00	12	73	16	1	39,73
PROF442057	15,00	12	73	16	1	45,10
PROF442058	16,00	16	79	19	1	41,38
PROF442059	17,00	16	79	19	1	52,73
PROF442060	18,00	16	79	19	1	52,73
PROF442061	19,00	16	79	19	1	63,90
PROF442062	20,00	20	88	22	1	61,40
PROF442063	22,00	20	88	22	1	81,48
PROF442064	24,00	25	102	26	1	101,05
PROF442065	25,00	25	102	26	1	96,90
PROF442066	28,00	25	102	26	1	126,23
PROF442067	30,00	25	102	26	1	139,13
PROF442068	32,00	32	112	32	1	141,96
PROF442069	36,00	32	112	32	1	182,20
PROF442070	40,00	40	130	48	1	225,36

FRESAS FRONTAIS 3 NAVALHAS CABO CILÍNDRICO HSS-CO 8% E TIALSIN

3Z HSS-CO 8% FINISHING END MILLS

FRAISES FRONTAUX 3 COUTEAUX CÂBLE CYLINDRIQUE HSSE 8% ET TIALSIN

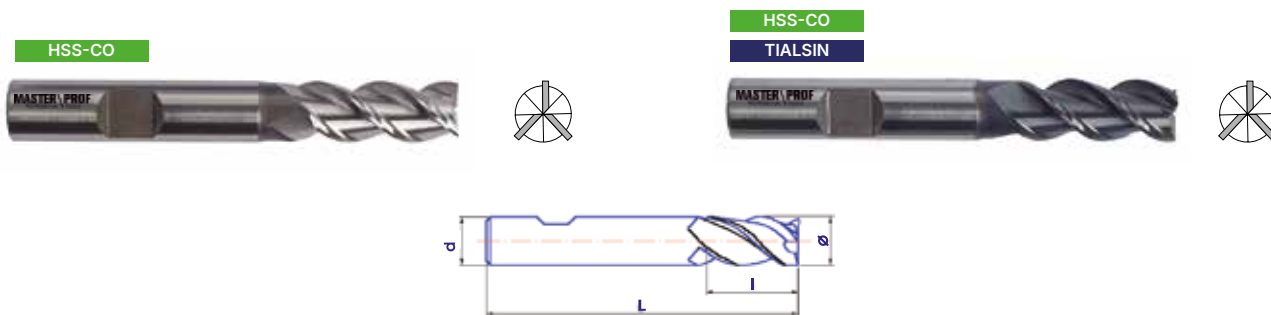

HSSE 8% Co

CÓDIGO	Ø	d mm	L mm	l mm	PCS	€
PROF443001	2,00	6	51	7	1	13,38
PROF443002	2,50	6	51	8	1	13,38
PROF443003	3,00	6	52	8	1	13,05
PROF443004	3,50	6	55	11	1	13,79
PROF443005	4,00	6	55	11	1	13,38
PROF443006	4,50	6	57	11	1	14,74
PROF443007	5,00	6	57	13	1	13,38
PROF443008	5,50	6	57	13	1	17,60
PROF443009	6,00	6	57	13	1	14,49
PROF443010	6,50	10	66	16	1	21,45
PROF443011	7,00	10	66	16	1	19,65
PROF443012	7,50	10	66	16	1	22,91
PROF443013	8,00	10	69	19	1	17,68
PROF443014	8,50	10	69	19	1	24,13
PROF443015	9,00	10	69	19	1	21,87
PROF443016	9,50	10	72	19	1	26,13
PROF443017	10,00	10	72	22	1	19,02
PROF443018	11,00	12	79	22	1	26,49
PROF443019	12,00	12	83	26	1	23,87
PROF443020	13,00	12	83	26	1	34,06
PROF443021	14,00	12	83	26	1	33,56
PROF443022	15,00	12	83	26	1	36,72
PROF443023	16,00	16	92	32	1	35,85
PROF443024	17,00	16	92	32	1	49,97
PROF443025	18,00	16	92	32	1	44,94
PROF443026	19,00	16	92	32	1	60,31
PROF443027	20,00	20	104	38	1	51,65
PROF443028	22,00	20	104	38	1	71,74
PROF443029	25,00	25	121	45	1	93,25
PROF443030	28,00	25	121	45	1	111,35
PROF443031	30,00	25	121	45	1	128,89
PROF443032	32,00	32	133	53	1	135,70

TIALSIN

CÓDIGO	Ø	d mm	L mm	l mm	PCS	€
PROF443033	2,00	6	51	7	1	21,07
PROF443034	2,50	6	51	8	1	21,07
PROF443035	3,00	6	52	8	1	20,55
PROF443036	3,50	6	55	11	1	21,92
PROF443037	4,00	6	55	11	1	21,31
PROF443038	4,50	6	57	11	1	22,91
PROF443039	5,00	6	57	13	1	21,54
PROF443040	5,50	6	57	13	1	24,94
PROF443041	6,00	6	57	13	1	22,19
PROF443042	6,50	10	66	16	1	30,78
PROF443043	7,00	10	66	16	1	30,55
PROF443044	7,50	10	66	16	1	32,97
PROF443045	8,00	10	69	19	1	30,83
PROF443046	8,50	10	69	19	1	33,51
PROF443047	9,00	10	69	19	1	32,15
PROF443048	9,50	10	72	19	1	35,17
PROF443049	10,00	10	72	22	1	31,21
PROF443050	11,00	12	79	22	1	38,00
PROF443051	12,00	12	83	26	1	35,80
PROF443052	13,00	12	83	26	1	46,99
PROF443053	14,00	12	83	26	1	45,71
PROF443054	15,00	12	83	26	1	51,31
PROF443055	16,00	16	92	32	1	59,35
PROF443056	17,00	16	92	32	1	69,64
PROF443057	18,00	16	92	32	1	66,39
PROF443058	19,00	16	92	32	1	77,13
PROF443059	20,00	20	104	38	1	74,08
PROF443060	22,00	20	104	38	1	97,37
PROF443061	25,00	25	121	45	1	125,60
PROF443062	28,00	25	121	45	1	147,71
PROF443063	30,00	25	121	45	1	165,08
PROF443064	32,00	32	133	53	1	168,92

FRESAS FRONTAIS 4 NAVALHAS CABO CILÍNDRICO HSS-CO 8% E TIALSIN

4Z HSS-CO 8% FINISHING END MILLS

FRAISES FRONTAUX 4 COUTEAUX CÂBLE CYLINDRIQUE HSSE 8% ET TIALSIN

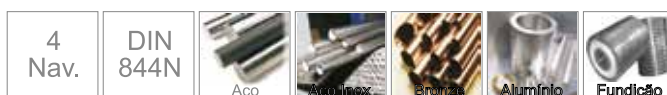
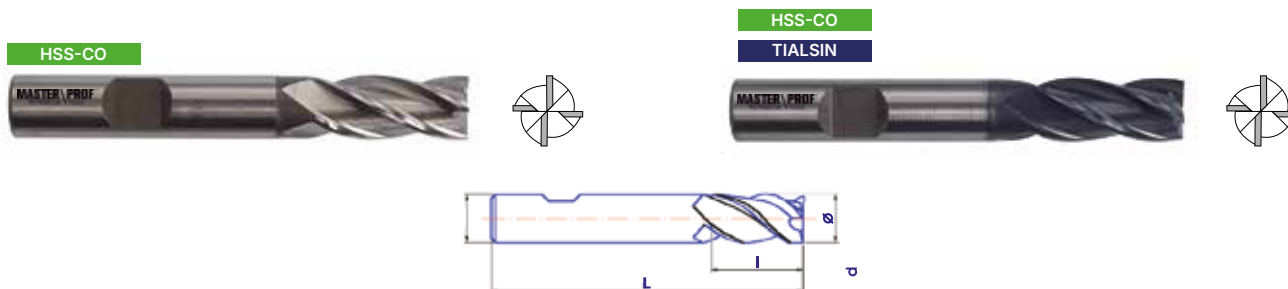

HSSE 8% Co

CÓDIGO	Ø	d mm	L mm	l mm	PCS	€
PROF460001	2,00	6	51	7	1	12,43
PROF460002	2,50	6	51	8	1	12,43
PROF460003	3,00	6	52	8	1	12,43
PROF460004	3,50	6	54	10	1	12,81
PROF460005	4,00	6	55	11	1	12,43
PROF460006	4,50	6	55	11	1	13,69
PROF460007	5,00	6	57	13	1	12,43
PROF460008	5,50	6	57	13	1	19,92
PROF460009	6,00	6	57	13	1	13,03
PROF460010	6,50	10	66	16	1	19,92
PROF460011	7,00	10	66	16	1	18,24
PROF460012	7,50	10	66	16	1	23,51
PROF460013	8,00	10	69	19	1	16,27
PROF460014	8,50	10	69	19	1	24,52
PROF460015	9,00	10	69	19	1	20,38
PROF460016	9,50	10	69	19	1	25,96
PROF460017	10,00	10	63	22	1	17,64
PROF460018	11,00	12	72	22	1	24,58
PROF460019	12,00	12	79	26	1	22,17
PROF460020	13,00	12	83	26	1	31,63
PROF460021	14,00	12	83	26	1	30,43
PROF460022	15,00	12	83	26	1	34,08
PROF460023	16,00	16	92	32	1	33,28
PROF460024	17,00	16	92	32	1	40,94
PROF460025	18,00	16	92	32	1	41,76
PROF460026	19,00	16	92	32	1	47,96
PROF460027	20,00	20	104	38	1	47,96
PROF460028	22,00	20	104	38	1	62,98
PROF460029	24,00	25	121	45	1	82,72
PROF460030	25,00	25	121	45	1	82,72
PROF460031	26,00	25	121	45	1	94,90
PROF460032	28,00	25	121	45	1	97,79
PROF460033	30,00	25	121	45	1	113,18
PROF460034	32,00	32	133	53	1	116,59
PROF460035	36,00	32	133	53	1	152,56
PROF460036	40,00	40	155	63	1	183,41

A partir da medida 25mm sem corte ao centro

TIALSIN

CÓDIGO	Ø	d mm	L mm	l mm	PCS	€
PROF460037	2,00	6	51	7	1	20,87
PROF460038	2,50	6	51	8	1	20,87
PROF460039	3,00	6	52	8	1	20,87
PROF460040	3,50	6	54	10	1	21,20
PROF460041	4,00	6	55	11	1	20,87
PROF460042	4,50	6	55	11	1	21,20
PROF460043	5,00	6	57	13	1	20,87
PROF460044	5,50	6	57	13	1	27,10
PROF460045	6,00	6	57	13	1	20,87
PROF460046	6,50	10	66	16	1	31,15
PROF460047	7,00	10	66	16	1	30,31
PROF460048	7,50	10	66	16	1	33,82
PROF460049	8,00	10	69	19	1	27,89
PROF460050	8,50	10	69	19	1	34,60
PROF460051	9,00	10	69	19	1	30,94
PROF460052	9,50	10	69	19	1	35,64
PROF460053	10,00	10	63	22	1	29,63
PROF460054	11,00	12	72	22	1	35,62
PROF460055	12,00	12	79	26	1	33,05
PROF460056	13,00	12	83	26	1	44,55
PROF460057	14,00	12	83	26	1	43,11
PROF460058	15,00	12	83	26	1	46,53
PROF460059	16,00	16	92	32	1	45,89
PROF460060	17,00	16	92	32	1	64,49
PROF460061	18,00	16	92	32	1	61,69
PROF460062	19,00	16	92	32	1	66,88
PROF460063	20,00	20	104	38	1	70,15
PROF460064	22,00	20	104	38	1	91,78
PROF460065	24,00	25	121	45	1	114,29
PROF460066	25,00	25	121	45	1	114,29
PROF460067	26,00	25	121	45	1	128,61
PROF460068	28,00	25	121	45	1	131,04
PROF460069	30,00	25	121	45	1	144,25
PROF460070	32,00	32	133	53	1	171,63
PROF460071	36,00	32	133	53	1	254,98
PROF460072	40,00	40	155	63	1	279,20

A partir da medida 25mm sem corte ao centro

FRESAS FRONTAIS 4 NAV. CABO CIL. C/ CENTRO DESBASTE HSS-CO 8% E TIALSIN

4Z HSS-CO 8% FINISHING END MILLS

FRAISES FRONTALES 4 COUTEAUX CÂBLE CIL. AVEC CENTRE D'ÉBAUCHE HSSE 8% ET TIALSIN

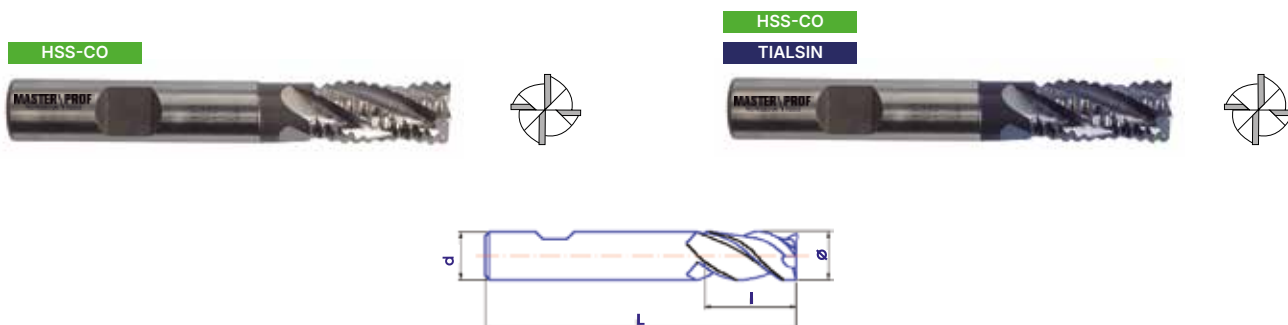

HSSE 8% Co

CÓDIGO	Ø	d mm	L mm	l mm	PCS	€
PROF464001	6,00	6	57	13	1	31,18
PROF464002	7,00	10	66	16	1	37,54
PROF464003	8,00	10	69	19	1	32,55
PROF464004	9,00	10	69	19	1	38,96
PROF464005	10,00	10	69	22	1	32,59
PROF464006	11,00	12	72	22	1	47,66
PROF464007	12,00	12	79	26	1	38,97
PROF464008	13,00	12	83	26	1	55,40
PROF464009	14,00	12	83	26	1	45,61
PROF464010	15,00	12	83	26	1	59,97
PROF464011	16,00	16	83	32	1	53,75
PROF464012	17,00	16	92	32	1	73,82
PROF464013	18,00	16	92	32	1	58,99
PROF464014	19,00	16	92	32	1	86,70
PROF464015	20,00	20	92	38	1	73,92
PROF464016	22,00	20	104	38	1	87,49
PROF464017	24,00	25	104	45	1	110,06
PROF464018	25,00	25	121	45	1	109,26
PROF464019	26,00	25	121	45	1	126,83
PROF464020	28,00	25	121	45	1	126,38
PROF464021	30,00	25	121	45	1	140,34
PROF464022	32,00	32	133	53	1	153,90
PROF464023	36,00	32	133	53	1	182,24
PROF464024	40,00	40	155	63	1	204,92

TIALSIN

CÓDIGO	Ø	d mm	L mm	l mm	PCS	€
PROF464025	6,00	6	57	13	1	38,43
PROF464026	7,00	10	66	16	1	45,89
PROF464027	8,00	10	69	19	1	40,91
PROF464028	9,00	10	69	19	1	48,09
PROF464029	10,00	10	69	22	1	40,57
PROF464030	11,00	12	72	22	1	59,71
PROF464031	12,00	12	79	26	1	53,56
PROF464032	13,00	12	83	26	1	66,94
PROF464033	14,00	12	83	26	1	58,25
PROF464034	15,00	12	83	26	1	73,57
PROF464035	16,00	16	83	32	1	67,46
PROF464036	17,00	16	92	32	1	89,85
PROF464037	18,00	16	92	32	1	75,72
PROF464038	19,00	16	92	32	1	103,37
PROF464039	20,00	20	92	38	1	93,75
PROF464040	22,00	20	104	38	1	110,65
PROF464041	24,00	25	104	45	1	118,04
PROF464042	25,00	25	121	45	1	129,41
PROF464043	26,00	25	121	45	1	147,87
PROF464044	28,00	25	121	45	1	147,47
PROF464045	30,00	25	121	45	1	160,03
PROF464046	32,00	32	133	53	1	196,00
PROF464047	36,00	32	133	53	1	251,59
PROF464048	40,00	40	155	63	1	266,27

FRESAS FRONTAIS 2 NAV. CABO CIL. C/ CENTRO METAL DURO E CROMAX

2Z CARBIDE END MILLS

FRAISES FRONTAUX 2 COUTEAUX CÂBLE CIL. AVEC CENTRE EN MÉTAL DUR ET CHROMAX



METAL DURO



Metal Duro (K30)

CÓDIGO	Ø	d mm	L mm	l mm	PCS	€
PROF942101	1,00	1,00	40	3,00	1	17,70
PROF942102	1,50	1,50	40	3,00	1	17,70
PROF942103	2,00	2,00	40	8,00	1	17,70
PROF942104	2,50	2,50	40	8,00	1	17,70
PROF942105	3,00	3,00	38	8,00	1	17,70
PROF942106	3,50	3,50	50	8,00	1	17,70
PROF942107	4,00	4,00	50	8,00	1	17,70
PROF942108	4,50	4,50	50	8,00	1	19,24
PROF942109	5,00	5,00	50	10,00	1	19,24
PROF942110	5,50	5,50	57	10,00	1	20,80
PROF942111	6,00	6,00	57	10,00	1	20,80
PROF942112	6,50	6,50	60	13,00	1	31,74
PROF942113	8,00	8,00	63	16,00	1	33,15
PROF942114	8,50	8,50	67	16,00	1	43,53
PROF942115	10,00	10,00	72	19,00	1	46,40
PROF942116	12,00	12,00	83	22,00	1	63,90
PROF942117	14,00	14,00	83	22,00	1	95,53
PROF942118	16,00	16,00	92	26,00	1	106,63
PROF942119	18,00	18,00	92	26,00	1	175,63
PROF942120	20,00	20,00	104	32,00	1	189,02



METAL DURO CROMAX

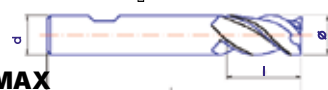

Metal Duro (K30) CROMAX

CÓDIGO	Ø	d mm	L mm	l mm	PCS	€
PROF942125	1,00	1,00	40	3,00	1	24,87
PROF942126	1,50	1,50	40	3,00	1	24,87
PROF942127	2,00	2,00	40	8,00	1	24,87
PROF942128	2,50	2,50	40	8,00	1	24,87
PROF942129	3,00	3,00	38	8,00	1	24,87
PROF942130	3,50	3,50	50	8,00	1	24,87
PROF942131	4,00	4,00	50	8,00	1	24,87
PROF942132	4,50	4,50	50	8,00	1	26,39
PROF942133	5,00	5,00	50	10,00	1	26,39
PROF942134	5,50	5,50	57	10,00	1	27,97
PROF942135	6,00	6,00	57	10,00	1	27,97
PROF942136	6,50	6,50	60	13,00	1	39,99
PROF942137	8,00	8,00	63	16,00	1	41,41
PROF942138	8,50	8,50	67	16,00	1	52,60
PROF942139	10,00	10,00	72	19,00	1	55,47
PROF942140	12,00	12,00	83	22,00	1	73,72
PROF942141	14,00	14,00	83	22,00	1	106,56
PROF942142	16,00	16,00	92	26,00	1	119,58
PROF942143	18,00	18,00	92	26,00	1	190,21
PROF942144	20,00	20,00	104	32,00	1	204,97

FRESAS FRONTAIS 3 NAV. CABO CIL. C/ CENTRO METAL DURO E CROMAX

3Z CARBIDE END MILLS

FRAISES FRONTAUX 3 COUTEAUX CÂBLE CIL. AVEC CENTRE EN MÉTAL DUR ET CHROMAX



METAL DURO



Metal Duro (K30)

CÓDIGO	Ø	d mm	L mm	l mm	PCS	€
PROF943101	1,00	1,00	40	3,00	1	17,70
PROF943102	1,50	1,50	40	3,00	1	17,70
PROF943103	2,00	2,00	40	8,00	1	17,70
PROF943104	2,50	2,50	40	8,00	1	17,70
PROF943105	3,00	3,00	38	8,00	1	17,70
PROF943106	3,50	3,50	50	8,00	1	17,70
PROF943107	4,00	4,00	50	8,00	1	17,70
PROF943108	4,50	4,50	50	8,00	1	19,24
PROF943109	5,00	5,00	50	10,00	1	19,24
PROF943110	5,50	5,50	57	10,00	1	20,80
PROF943111	6,00	6,00	57	10,00	1	20,80
PROF943112	6,50	6,50	60	13,00	1	31,74
PROF943113	8,00	8,00	63	16,00	1	33,17
PROF943114	8,50	8,50	67	16,00	1	43,53
PROF943115	10,00	10,00	72	19,00	1	46,40
PROF943116	12,00	12,00	83	22,00	1	63,90
PROF943117	14,00	14,00	83	22,00	1	95,53
PROF943118	16,00	16,00	92	26,00	1	106,63
PROF943119	18,00	18,00	92	26,00	1	175,63
PROF943120	20,00	20,00	104	32,00	1	189,04



METAL DURO CROMAX

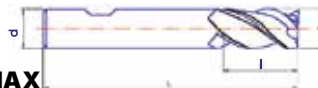

Metal Duro (K30) CROMAX

CÓDIGO	Ø	d mm	L mm	l mm	PCS	€
PROF943125	1,00	1,00	40	3,00	1	24,87
PROF943126	1,50	1,50	40	3,00	1	24,87
PROF943127	2,00	2,00	40	8,00	1	24,87
PROF943128	2,50	2,50	40	8,00	1	24,87
PROF943129	3,00	3,00	38	8,00	1	24,87
PROF943130	3,50	3,50	50	8,00	1	24,87
PROF943131	4,00	4,00	50	8,00	1	24,87
PROF943132	4,50	4,50	50	8,00	1	26,39
PROF943133	5,00	5,00	50	10,00	1	26,39
PROF943134	5,50	5,50	57	10,00	1	27,97
PROF943135	6,00	6,00	57	10,00	1	27,97
PROF943136	6,50	6,50	60	13,00	1	39,99
PROF943137	8,00	8,00	63	16,00	1	41,41
PROF943138	8,50	8,50	67	16,00	1	52,60
PROF943139	10,00	10,00	72	19,00	1	55,47
PROF943140	12,00	12,00	83	22,00	1	73,72
PROF943141	14,00	14,00	83	22,00	1	106,56
PROF943142	16,00	16,00	92	26,00	1	119,58
PROF943143	18,00	18,00	92	26,00	1	190,21
PROF943144	20,00	20,00	104	32,00	1	204,97

FRESAS FRONTAIS 4 NAV. CABO CIL. C/ CENTRO METAL DURO E CROMAX

4Z CARBIDE END MILLS

FRAISES FRONTAUX 4 COUTEAUX CÂBLE CIL. AVEC CENTRE EN MÉTAL DUR ET CHROMAX

METAL DURO



METAL DURO

CROMAX



Metal Duro (K30)

CÓDIGO	Ø	d mm	L mm	l mm	PCS	€
PROF940101	1,00	3,00	40	3,00	1	17,70
PROF940102	1,50	3,00	40	3,00	1	17,70
PROF940103	2,00	3,00	40	8,00	1	17,70
PROF940104	2,50	3,00	40	8,00	1	17,70
PROF940105	3,00	3,00	38	8,00	1	17,70
PROF940106	3,50	3,50	50	8,00	1	17,70
PROF940107	4,00	4,00	50	8,00	1	17,70
PROF940108	4,50	4,50	50	8,00	1	17,70
PROF940109	5,00	5,00	50	10,00	1	19,24
PROF940110	5,50	5,50	57	10,00	1	20,80
PROF940111	6,00	6,00	57	10,00	1	20,80
PROF940112	6,50	6,50	60	13,00	1	31,74
PROF940113	8,00	8,00	63	16,00	1	33,17
PROF940114	8,50	8,50	67	16,00	1	43,53
PROF940115	10,00	10,00	72	19,00	1	46,40
PROF940116	12,00	12,00	83	22,00	1	63,90
PROF940117	14,00	14,00	83	22,00	1	95,53
PROF940118	16,00	16,00	92	26,00	1	106,63
PROF940119	18,00	18,00	92	26,00	1	175,63
PROF940120	20,00	20,00	104	32,00	1	189,04

Metal Duro (K30) CROMAX

CÓDIGO	Ø	d mm	L mm	l mm	PCS	€
PROF940125	1,00	3,00	40	3,00	1	24,87
PROF940126	1,50	3,00	40	3,00	1	24,87
PROF940127	2,00	3,00	40	8,00	1	24,87
PROF940128	2,50	3,00	40	8,00	1	24,87
PROF940129	3,00	3,00	38	8,00	1	24,87
PROF940130	3,50	3,50	50	8,00	1	24,87
PROF940131	4,00	4,00	50	8,00	1	24,87
PROF940132	4,50	4,50	50	8,00	1	26,39
PROF940133	5,00	5,00	50	10,00	1	26,39
PROF940134	5,50	5,50	57	10,00	1	27,97
PROF940135	6,00	6,00	57	10,00	1	27,97
PROF940136	6,50	6,50	60	13,00	1	39,99
PROF940137	8,00	8,00	63	16,00	1	41,41
PROF940138	8,50	8,50	67	16,00	1	52,60
PROF940139	10,00	10,00	72	19,00	1	55,47
PROF940140	12,00	12,00	83	22,00	1	73,72
PROF940141	14,00	14,00	83	22,00	1	106,58
PROF940142	16,00	16,00	92	26,00	1	119,56
PROF940143	18,00	18,00	92	26,00	1	190,21
PROF940144	20,00	20,00	104	32,00	1	204,98

MÁQUINAS ELETROMAGNÉTICAS

MAGNETIC DRILL FOR MAX Ø 35 MM ANNULAR CUTTERS

MACHINE À BASE ÉLECTROMAGNÉTIQUE POUR FRAISES JUSQU'À Ø 35 MM

MASTERBASIC

Máquina com base magnética para fresas

Até Ø 35 mm



Capacidade de furação

Fresa Eletromagnética (Ø max)	12 - 35 mm
Broca helicoidal (Ø max)	1 - 13 mm
Escareador (Ø max)	10 - 35 mm

Dimensão da máquina

Altura	293 - 383 mm
Comprimento	265 mm
Largura	175 mm
Curso	90 mm
Peso	8,5 Kg



35 mm 13 mm 35 mm



8,5 Kg 850 W 1000 Kg 90 mm

Magnética (L x W x H) 160x81x36 mm

Força Magnética 1000 Kg

Potência do Motor 850 W

Voltagem 220-240 AC / 50-60 Hz

Velocidade (sem carga) 750 rpm

Velocidade (com carga) 400 rpm

Encaixe Weldon 19,05 mm

MASTERBASIC: Esquema de utilização dos acessórios



Adaptador
Weldon 19.05 - Quick-in



WELDON



Quick-IN

MASTER BASIC

Composição

1 x base magnética
1 x proteção de segurança
3 x cabos
1 x chave hexagonal 2,5 mm
1 x chave hexagonal 3 mm
1 x chave hexagonal 4 mm
1 x chave hexagonal 5 mm
1 x sistema de lubrificação
1 x corrente de segurança
1 x manual de utilização
1 x expulsor

CÓDIGO

€

MFMEM03

630,00

MÁQUINAS ELETROMAGNÉTICAS

MAGNETIC DRILL FOR MAX Ø 50 MM ANNULAR CUTTERS, 2 GEARS

MACHINE AVEC BASE ÉLECTROMAGNÉTIQUE POUR FRAISES JUSQU'À Ø 50 MM, DEUX VITESSES

MASTERELITE

Máquina com base magnética para fresas

Até Ø 50 mm, Duas velocidades



Capacidade de furação

Fresa Eletromagnética (Ø max)	12 - 50 mm
Broca helicoidal (Ø max)	1 - 20 mm
Escareador (Ø max)	10 - 50 mm

Dimensão da máquina

Altura	385 - 550 mm
Comprimento	320 mm
Largura	210 mm
Curso	170 mm
Peso	13,5 Kg

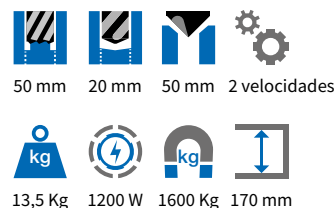

Magnética (L x W x H)	168x84x49 mm
Força Magnética	1600 Kg
Potência do Motor	1200 W
Voltagem	220-240 AC/50-60 Hz
Velocidade (sem carga)	380 rpm / 690 rpm
Velocidade (com carga)	235 rpm / 425 rpm
Encaixe	Weldon 19,05 mm

MASTERELITE: Esquema de utilização dos acessórios



MASTER ELITE	
Composição	
1 x base magnética	
1 x proteção de segurança	
3 x cabos	
1 x chave hexagonal 2,5 mm	
1 x chave hexagonal 3 mm	
1 x chave hexagonal 4 mm	
1 x chave hexagonal 5 mm	
1 x sistema de lubrificação	
1 x corrente de segurança	
1 x manual de utilização	
1 x expulsor	
CÓDIGO	€
MFMEM02	945,00

MÁQUINAS ELETROMAGNÉTICAS

MAGNETIC DRILL FOR MAX Ø 32 MM ANNULAR CUTTERS, ADJUSTABLE SPEED AND R/L ROTATION

MACHINE À BASE ÉLECTROMAGNÉTIQUE POUR FRAISES JUSQU'À Ø 32 MM, VITESSE VARIABLE ET INVERSION DE ROTATION

MASTERPRO

Máquina com Base Magnética para Fresas

Até Ø 32 mm, velocidade variável e inversão de rotação



32 mm 13 mm 40 mm M12



11 Kg



1000 W



1500Kg



150 mm



Velocidade variável



Inversão de rotação

Capacidade de furação

Fresa Eletromagnética (Ø max)	12 - 32 mm
Broca helicoidal (Ø max)	1 - 13 mm
Escareador (Ø max)	10 - 40 mm
Macho de máquina (Ø)	M3 - M12

Dimensões da máquina

Altura	370 - 512 mm
Comprimento	320 mm
Largura	210 mm
Curso	150 mm
Peso	11 Kg

Magnética (L x W x H)	160x80x42 mm
Força Magnética	1500 Kg
Potência do Motor	1000 W
Voltagem	220-240 AC/50-60 Hz
Velocidade (sem carga)	100 - 600 rpm
Velocidade (com carga 1000W, 9,1A)	225 rpm
Encaixe	Weldon 19,05 mm

MASTER PRO	
Composição	
1 x base magnética	
1 x proteção de segurança	
3 x cabos	
3 x adaptadores weldon para machos com cabo Ø 7,8,9	
1 x chave 2,5 mm	
1 x chave hexagonal 3 mm	
1 x chave hexagonal 4 mm	
1 x chave hexagonal 5 mm	
1 x sistema de lubrificação	
1 x corrente de segurança	
1 x manual de utilização	
1 x expulsor	
CÓDIGO	€
MFMEM01	1449,00

MÁQUINA PARA UTILIZAÇÃO COM MACHOS E FAZER ROSCAS

MÁQUINAS ELETROMAGNÉTICAS

MAGNETIC DRILL FOR MAX Ø 32 MM ANNULAR CUTTERS, ADJUSTABLE SPEED AND R/L ROTATION
MACHINE À BASE ÉLECTROMAGNÉTIQUE POUR FRAISES JUSQU'À Ø 32 MM, VITESSE VARIABLE ET INVERSION DE ROTATION

MASTERPROF: Esquema de utilização dos acessórios



(incluído)

Adaptador de Macho de máquina com gambo Ø 7 mm

(incluído)

Adaptador de Macho de máquina com cabo Ø 8 mm

(incluído)

Adaptador de Macho de máquina com cabo Ø 9 mm



WELDON



Adaptador Weldon 19.05 Quick-in



Quick-IN



Adaptador Weldon 19.05 - 1/2 UNF



Bucha Encaixe 1/2 x 20 UNF



FRESAS PARA MÁQUINAS ELETROMAGNÉTICA EM M2L (HSS + ALUMÍNIO)

WELDON SHANK HSS CORE DRILLS FOR MAGNETIC MACHINES

FRAISES HSS À CAROTTER AVEC WELDON QUEUE POUR MACHINES À EMBASE ÉLECTROMAGNÉTIQUE

HSS M2L



HSS M2L



Série Curta

CÓDIGO	Ø	PCS	€
MFME01	12	1	21,05
MFME02	13	1	21,05
MFME03	14	1	21,82
MFME04	15	1	22,73
MFME05	16	1	23,65
MFME06	17	1	24,40
MFME07	18	1	25,32
MFME08	19	1	25,92
MFME09	20	1	27,15
MFME10	21	1	28,98
MFME11	22	1	30,04
MFME12	23	1	31,28
MFME13	24	1	32,49
MFME14	25	1	33,56
MFME15	26	1	34,77
MFME16	27	1	35,09
MFME17	28	1	37,21
MFME18	29	1	38,45
MFME19	30	1	40,19
MFME20	31	1	43,02
MFME21	32	1	46,06
MFME22	33	1	48,51
MFME23	34	1	57,06
MFME24	35	1	63,15
MFME25	36	1	64,69
MFME26	37	1	65,84
MFME27	38	1	66,51
MFME28	39	1	67,12
MFME29	40	1	67,73
MFME30	41	1	68,95

Série Curta

CÓDIGO	Ø	PCS	€
MFME31	42	1	73,53
MFME32	43	1	76,89
MFME39	44	1	78,73
MFME33	45	1	80,24
MFME34	46	1	82,07
MFME35	47	1	83,59
MFME36	48	1	86,94
MFME37	49	1	87,57
MFME38	50	1	92,75
MFME40	51	1	94,68
MFME41	52	1	96,83
MFME42	53	1	98,94
MFME43	54	1	101,10
MFME44	55	1	103,83
MFME45	56	1	104,91
MFME46	57	1	106,95
MFME47	58	1	108,98
MFME48	59	1	111,04
MFME49	60	1	113,13
MFME51	61	1	129,96
MFME52	62	1	127,46
MFME53	63	1	129,68
MFME54	64	1	132,56
MFME55	65	1	135,44
MFME56	66	1	138,38
MFME57	67	1	141,32
MFME58	68	1	144,36
MFME59	69	1	147,41
MFME60	70	1	150,51

Série Longa

CÓDIGO	Ø	PCS	€
MFMELO1	12	1	30,21
MFMELO2	13	1	30,21
MFMELO3	14	1	30,21
MFMELO4	15	1	33,56
MFMELO5	16	1	33,56
MFMELO6	17	1	34,77
MFMELO7	18	1	37,38
MFMELO8	19	1	38,14
MFMELO9	20	1	39,21
MFMELO10	21	1	43,63
MFMELO11	22	1	44,85
MFMELO12	23	1	46,38
MFMELO13	24	1	47,74
MFMELO14	25	1	49,12
MFMELO15	26	1	50,65
MFMELO16	27	1	53,07
MFMELO17	28	1	55,52
MFMELO18	29	1	57,66
MFMELO19	30	1	60,10
MFMELO20	31	1	63,15
MFMELO21	32	1	65,90
MFMELO22	33	1	68,95
MFMELO23	34	1	72,00
MFMELO24	35	1	75,05
MFMELO25	36	1	77,20
MFMELO26	37	1	82,38
MFMELO27	38	1	82,38
MFMELO28	39	1	88,48
MFMELO29	40	1	93,05
MFMELO30	41	1	94,58

Série Longa

CÓDIGO	Ø	PCS	€
MFMELO31	42	1	95,79
MFMELO32	43	1	98,24
MFMELO39	44	1	100,57
MFMELO33	45	1	102,52
MFMELO34	46	1	103,73
MFMELO35	47	1	109,54
MFMELO36	48	1	112,28
MFMELO37	49	1	112,88
MFMELO38	50	1	115,32
MFMELO40	51	1	116,60
MFMELO41	52	1	120,68
MFMELO42	53	1	124,24
MFMELO43	54	1	127,28
MFMELO44	55	1	130,80
MFMELO45	56	1	130,88
MFMELO46	57	1	133,71
MFMELO47	58	1	136,55
MFMELO48	59	1	139,46
MFMELO49	60	1	153,05
MFMELO51	61	1	158,06
MFMELO52	62	1	161,29
MFMELO53	63	1	164,58
MFMELO54	64	1	167,90
MFMELO55	65	1	171,27
MFMELO56	66	1	174,69
MFMELO57	67	1	178,21
MFMELO58	68	1	181,72
MFMELO59	69	1	185,33
MFMELO60	70	1	188,94

FRESAS PARA MÁQUINAS ELETROMAGNÉTICA EM M2L (HSS + ALUMÍNIO)

WELDON SHANK HSS CORE DRILLS FOR MAGNETIC MACHINES

FRAISES HSS À CAROTTER AVEC WELDON QUEUE POUR MACHINES À EMBASE ÉLECTROMAGNÉTIQUE

HSS

**Encaixe
FEIN**



Série Curta

CÓDIGO	Ø	PCS	€
MFMEF01	12	1	21,05
MFMEF02	13	1	21,05
MFMEF03	14	1	21,82
MFMEF04	15	1	22,73
MFMEF05	16	1	23,65
MFMEF06	17	1	24,40
MFMEF07	18	1	25,32
MFMEF08	19	1	25,92
MFMEF09	20	1	27,15
MFMEF10	21	1	28,98
MFMEF11	22	1	30,04
MFMEF12	23	1	31,28
MFMEF13	24	1	32,49
MFMEF14	25	1	33,56
MFMEF15	26	1	34,77
MFMEF16	27	1	35,09
MFMEF17	28	1	37,21
MFMEF18	29	1	38,45
MFMEF19	30	1	40,19
MFMEF20	31	1	43,02

Série Curta

CÓDIGO	Ø	PCS	€
MFMEF21	32	1	46,06
MFMEF22	33	1	48,51
MFMEF23	34	1	57,06
MFMEF24	35	1	63,15
MFMEF25	36	1	64,69
MFMEF26	37	1	65,84
MFMEF27	38	1	66,51
MFMEF28	39	1	67,12
MFMEF29	40	1	67,73
MFMEF30	41	1	68,95
MFMEF31	42	1	73,53
MFMEF32	43	1	76,89
MFMEF33	44	1	78,73
MFMEF34	45	1	80,24
MFMEF35	46	1	82,07
MFMEF36	47	1	83,59
MFMEF37	48	1	86,94
MFMEF38	49	1	87,57
MFMEF39	50	1	92,75



FRESAS PARA MÁQUINAS ELETROMAGNÉTICA EM HSS-CO 8% (P/ INOX)

WELDON SHANK HSS-CO 8% CORE DRILLS FOR MAGNETIC MACHINES

FRAISES HSS-CO 8% À CAROTTER AVEC WELDON QUEUE POUR MACHINES À EMBASE ÉLECTROMAGNÉTIQUE



Série Curta

CÓDIGO	Ø	PCS	€
MFMECO01	12	1	24,38
MFMECO02	13	1	25,94
MFMECO03	14	1	29,03
MFMECO04	15	1	31,12
MFMECO05	16	1	32,68
MFMECO06	17	1	32,68
MFMECO07	18	1	32,68
MFMECO08	19	1	32,68
MFMECO09	20	1	32,68
MFMECO10	21	1	33,74
MFMECO11	22	1	34,76
MFMECO12	23	1	36,83
MFMECO13	24	1	38,92
MFMECO14	25	1	41,50
MFMECO15	26	1	44,11
MFMECO16	27	1	45,65
MFMECO17	28	1	48,28
MFMECO18	29	1	50,84
MFMECO19	30	1	53,47
MFMECO20	31	1	56,03
MFMECO21	32	1	58,65
MFMECO22	33	1	61,22
MFMECO23	34	1	64,33
MFMECO24	35	1	66,94
MFMECO25	36	1	69,51
MFMECO26	37	1	72,65
MFMECO27	38	1	75,23
MFMECO28	39	1	78,33
MFMECO29	40	1	80,96
MFMECO30	41	1	84,05

Série Curta

CÓDIGO	Ø	PCS	€
MFMECO31	42	1	87,69
MFMECO32	43	1	90,30
MFMECO33	44	1	94,65
MFMECO34	45	1	97,57
MFMECO35	46	1	100,14
MFMECO36	47	1	103,77
MFMECO37	48	1	106,89
MFMECO38	49	1	110,51
MFMECO39	50	1	114,15
MFMECO40	51	1	118,31
MFMECO41	52	1	121,96
MFMECO42	53	1	127,14
MFMECO43	54	1	128,69
MFMECO44	55	1	132,33
MFMECO45	56	1	136,28
MFMECO46	57	1	140,36
MFMECO47	58	1	144,59
MFMECO48	59	1	148,90
MFMECO49	60	1	153,39
MFMECO50	61	1	172,11
MFMECO51	62	1	175,57
MFMECO52	63	1	179,07
MFMECO53	64	1	182,62
MFMECO54	65	1	186,30
MFMECO55	66	1	178,71
MFMECO56	67	1	182,30
MFMECO57	68	1	185,90
MFMECO58	69	1	189,58
MFMECO59	70	1	193,32

Série Longa

CÓDIGO	Ø	PCS	€
MFMELCO01	12	1	36,19
MFMELCO02	13	1	37,19
MFMELCO03	14	1	39,76
MFMELCO04	15	1	39,76
MFMELCO05	16	1	39,76
MFMELCO06	17	1	39,76
MFMELCO07	18	1	39,76
MFMELCO08	19	1	46,38
MFMELCO09	20	1	47,43
MFMELCO10	21	1	48,43
MFMELCO11	22	1	49,71
MFMELCO12	23	1	50,47
MFMELCO13	24	1	52,51
MFMELCO14	25	1	54,04
MFMELCO15	26	1	56,56
MFMELCO16	27	1	58,62
MFMELCO17	28	1	62,19
MFMELCO18	29	1	65,24
MFMELCO19	30	1	68,81
MFMELCO20	31	1	72,38
MFMELCO21	32	1	75,42
MFMELCO22	33	1	79,52
MFMELCO23	34	1	83,09
MFMELCO24	35	1	86,66
MFMELCO25	36	1	90,75
MFMELCO26	37	1	94,28
MFMELCO27	38	1	98,37
MFMELCO28	39	1	99,90
MFMELCO29	40	1	102,94
MFMELCO30	41	1	111,13

Série Longa

CÓDIGO	Ø	PCS	€
MFMELCO31	42	1	115,19
MFMELCO32	43	1	119,81
MFMELCO33	44	1	124,89
MFMELCO34	45	1	128,47
MFMELCO35	46	1	133,56
MFMELCO36	47	1	137,61
MFMELCO37	48	1	143,23
MFMELCO38	49	1	147,80
MFMELCO39	50	1	151,89
MFMELCO40	51	1	156,99
MFMELCO41	52	1	162,09
MFMELCO42	53	1	167,18
MFMELCO43	54	1	172,27
MFMELCO44	55	1	177,38
MFMELCO45	56	1	182,70
MFMELCO46	57	1	188,20
MFMELCO47	58	1	193,82
MFMELCO48	59	1	199,64
MFMELCO49	60	1	205,65
MFMELCO50	61	1	212,39
MFMELCO51	62	1	216,73
MFMELCO52	63	1	221,10
MFMELCO53	64	1	225,59
MFMELCO54	65	1	230,13
MFMELCO55	66	1	234,75
MFMELCO56	67	1	239,40
MFMELCO57	68	1	244,17
MFMELCO58	69	1	248,99
MFMELCO59	70	1	253,84

FRESAS PARA MÁQUINAS ELETROMAGNÉTICA EM HSS+TIALN

WELDON SHANK TIALN CORE DRILLS FOR MAGNETIC MACHINES

FRAISES TIALN À CAROTTER AVEC WELDON QUEUE POUR MACHINES À EMBASE ÉLECTROMAGNÉTIQUE



Série Curta

CÓDIGO	Ø	PCS	€
MFMETI01	12	1	46,96
MFMETI02	13	1	46,96
MFMETI03	14	1	50,41
MFMETI04	15	1	52,02
MFMETI05	16	1	53,97
MFMETI06	17	1	55,72
MFMETI07	18	1	57,75
MFMETI08	19	1	60,89
MFMETI09	20	1	62,29
MFMETI10	21	1	65,30
MFMETI11	22	1	66,72
MFMETI12	23	1	74,48
MFMETI13	24	1	77,72
MFMETI14	25	1	79,27
MFMETI15	26	1	97,53
MFMETI16	27	1	98,44
MFMETI17	28	1	100,24
MFMETI18	29	1	102,95
MFMETI19	30	1	104,75

Outras medidas sob consulta

Série Longa

CÓDIGO	Ø	PCS	€
MFMELTI01	12	1	60,10
MFMELTI02	13	1	60,10
MFMELTI03	14	1	61,36
MFMELTI04	15	1	63,74
MFMELTI05	16	1	67,04
MFMELTI06	17	1	70,60
MFMELTI07	18	1	73,09
MFMELTI08	19	1	75,93
MFMELTI09	20	1	77,44
MFMELTI10	21	1	80,41
MFMELTI11	22	1	82,25
MFMELTI12	23	1	89,50
MFMELTI13	24	1	93,53
MFMELTI14	25	1	95,15
MFMELTI15	26	1	115,30
MFMELTI16	27	1	116,92
MFMELTI17	28	1	119,33
MFMELTI18	29	1	120,94
MFMELTI19	30	1	126,60

Outras medidas sob consulta

FRESAS PARA MÁQUINAS ELETROMAGNÉTICAS EM TCT - DENTES METAL DURO

WELDON SHANK CARBIDE TIP CORE DRILLS FOR MAGNETIC MACHINES

FRAISES À CAROTTER AU CARBURE DE TUNGSTÈNE AVEC WELDON QUEUE POUR MACHINES À EMBASE ÉLECTROMAGNÉTIQUE

METAL DURO



Série Curta

CÓDIGO	Ø	PCS	€
MFMET01	12	1	41,44
MFMET02	13	1	41,44
MFMET03	14	1	41,44
MFMET04	15	1	41,44
MFMET05	16	1	41,44
MFMET06	17	1	41,44
MFMET07	18	1	41,44
MFMET08	19	1	41,44
MFMET09	20	1	41,44
MFMET10	21	1	43,24
MFMET11	22	1	43,24
MFMET12	23	1	43,24
MFMET13	24	1	43,24
MFMET14	25	1	43,24
MFMET15	26	1	50,04
MFMET16	27	1	50,04
MFMET17	28	1	50,04
MFMET18	29	1	50,04
MFMET19	30	1	50,04
MFMET20	31	1	60,06
MFMET21	32	1	60,06
MFMET22	33	1	60,06
MFMET23	34	1	60,06
MFMET24	35	1	60,06
MFMET25	36	1	68,87
MFMET26	37	1	68,87
MFMET27	38	1	68,87
MFMET28	39	1	68,87
MFMET29	40	1	68,87
MFMET30	41	1	83,69
MFMET31	42	1	83,69
MFMET32	43	1	83,69
MFMET33	44	1	83,69
MFMET34	45	1	83,69
MFMET35	46	1	90,09
MFMET36	47	1	90,09
MFMET37	48	1	90,09
MFMET38	49	1	90,09
MFMET39	50	1	94,49



Expositor em Acrílico

Composição 19 fresas

Ø	UN
12 x 35	1
14 x 35	1
16 x 35	1
17 x 35	1
18 x 35	1
20 x 35	1
22 x 35	1
23 x 35	1
24 x 35	1
26 x 35	1
27 x 35	1
28 x 35	1
30 x 35	1
32 x 35	1
35 x 35	1
38 x 35	1
40 x 35	1
45 x 35	1
50 x 35	1



Expositor em Vidro

Composição 19 fresas

Ø	UN
12 x 35	1
14 x 35	1
16 x 35	1
17 x 35	1
18 x 35	1
20 x 35	1
22 x 35	1
23 x 35	1
24 x 35	1
26 x 35	1
27 x 35	1
28 x 35	1
30 x 35	1
32 x 35	1
35 x 35	1
38 x 35	1
40 x 35	1
45 x 35	1
50 x 35	1

ADAPTADORES, EXPULSORES E PORTA FRESAS

CORE DRILLS ACCESSORIES FOR MAGNETIC MACHINES
ACCESSOIRES POUR FRAISES À CAROTTER

HSS

Adaptadores

CÓDIGO	Descrição	€
MFMEW01	Adaptador Weldon - 18 Fein	16,79
MFMEW02	Adaptador 18 Fein - Weldon	16,79



Expulsores

CÓDIGO	Descrição	€
MFME50	Expulsor 6,34x77mm para fresa de 30mm comp.	5,57
MFME150	Expulsor 6,34x103mm para fresa de 50mm comp.	6,01



Expulsores para Fresas TCT

CÓDIGO	Descrição	€
MFMET90	Expulsor 7,1x112mm para fresas de 12 a 16mm	19,22
MFMET91	Expulsor 8x112mm para fresas de 17 a 50mm	19,22



Porta Fresas sem Lubrificação para Fresas Eletromagnéticas

CÓDIGO	MT	L	WELDON 19,05mm	€
MFMEW10	2	160	12 ÷ 60	162,55
MFMEW11	3	175	12 ÷ 60	162,55



Porta Fresas com Lubrificação para Fresas Eletromagnéticas

CÓDIGO	MT	L	WELDON 19,05mm	€
MFMEW20	A 2	160	12 ÷ 60	232,21
MFMEW21*	A 3	160	12 ÷ 60	232,21
MFMEW22	B 2	160	12 ÷ 60	255,25
MFMEW23	B 3	160	12 ÷ 60	255,25

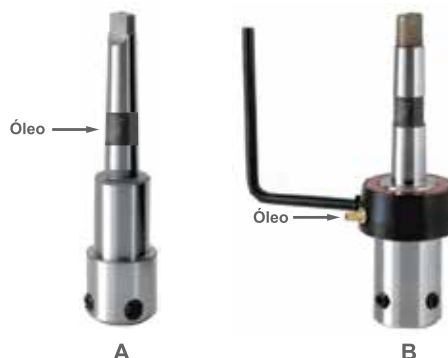

*Até fim de existência

EXPOSITORES E MALAS DE FRESAS P/ MÁQUINAS C/ BASE ELETROMAGNÉTICA

DISPLAYS AND CASES FOR CORE DRILLS

PRÉSENTOIRS ET COFFRETS DE COUPE POUR MACHINES À BASE ÉLECTROMAGNÉTIQUE

HSS M2L

M2L (HSS+Alumínio)



Expositor em Acrílico

Composição 20 fresas

Ø	UN
12 x 30	1
14 x 30	1
16 x 30	1
17 x 30	1
18 x 30	1
20 x 30	1
22 x 30	1
23 x 30	1
24 x 30	1
26 x 30	1
27 x 30	1
28 x 30	1
30 x 30	1
20 x 50	1
22 x 50	1
24 x 50	1
26 x 50	1
28 x 50	1
30 x 50	1
40 x 50	1

CÓDIGO €



Mala em HSS

Composição 7 peças

Ø	UN
12 x 30	1
14 x 30	1
16 x 30	1
18 x 30	1
20 x 30	1
22 x 30	1

1 Expulsor 6,34x77mm

OFERTA MALA

CÓDIGO €

MFMEE51 154,59

HSS-CO 8% (para inox)



Expositor em Acrílico

Composição 20 fresas

Ø	UN
12 x 30	1
14 x 30	1
16 x 30	1
17 x 30	1
18 x 30	1
20 x 30	1
22 x 30	1
23 x 30	1
24 x 30	1
26 x 30	1
27 x 30	1
28 x 30	1
30 x 30	1
20 x 50	1
22 x 50	1
24 x 50	1
26 x 50	1
28 x 50	1
30 x 50	1
40 x 50	1

OFERTA EXPOSITOR



Mala em HSS-CO 8%

Composição 7 peças

Ø	UN
12 x 30	1
14 x 30	1
16 x 30	1
18 x 30	1
20 x 30	1
22 x 30	1

1 Expulsor 6,34x77mm

OFERTA MALA

CÓDIGO €

MFMEECO2 191,76

FRESAS PERFURADORAS RETIFICADAS E JOGOS EM HSS

HSS HOLE CUTTERS

FRAISES DE PERÇAGE HSS RECTIFIÉES



Para furar inox, ferro fundido, chapa de aço e alumínio até 8mm de espessura



CÓDIGO	Ø	PCS	€	CÓDIGO	Ø	PCS	€
MFP12	12	1	12,28	MFP50	50	1	35,02
MFP13	13	1	12,28	MFP51	51	1	43,46
MFP14	14	1	12,54	MFP52	52	1	44,36
MFP15	15	1	12,54	MFP53	53	1	45,48
MFP16	16	1	12,54	MFP54	54	1	47,23
MFP17	17	1	12,54	MFP55	55	1	48,08
MFP18	18	1	12,54	MFP56	56	1	48,41
MFP19	19	1	12,94	MFP57	57	1	48,41
MFP20	20	1	13,72	MFP58	58	1	50,29
MFP21	21	1	14,36	MFP59	59	1	51,90
MFP22	22	1	15,01	MFP60	60	1	51,90
MFP23	23	1	16,17	MFP65	65	1	66,93
MFP24	24	1	16,44	MFP70	70	1	71,79
MFP25	25	1	16,99	MFP75	75	1	77,31
MFP26	26	1	18,13	MFP80	80	1	86,42
MFP27	27	1	18,42	MFP85	85	1	97,46
MFP28	28	1	19,17	MFP90	90	1	107,21
MFP29	29	1	19,85	MFP95	95	1	115,00
MFP30	30	1	20,20	MFP96	100	1	124,75
MFP31	31	1	21,02				
MFP32	32	1	21,66				
MFP33	33	1	22,36				
MFP34	34	1	23,14				
MFP35	35	1	23,68				
MFP36	36	1	24,82				
MFP37	37	1	25,09				
MFP38	38	1	25,76				
MFP39	39	1	27,94				
MFP40	40	1	27,94				
MFP41	41	1	28,29				
MFP42	42	1	28,88				
MFP43	43	1	29,89				
MFP44	44	1	30,44				
MFP45	45	1	31,42				
MFP46	46	1	31,68				
MFP47	47	1	32,48				
MFP48	48	1	34,36				
MFP49	49	1	35,02				
MFP50	50	1	35,02				

Expositor de Fresas em Acrílico					
Composição 21 fresas					
Ø 18,19,20,21,22,23,24,25,26,27,28,29,30,31,32,33,34,35,36,38,40					
(1 fresa de cada medida) OFERTA EXPOSITOR	<table border="1"> <thead> <tr> <th>CÓDIGO</th> <th>€</th> </tr> </thead> <tbody> <tr> <td>MFJPM18</td> <td>404,30</td> </tr> </tbody> </table>	CÓDIGO	€	MFJPM18	404,30
CÓDIGO	€				
MFJPM18	404,30				

Expositor de Fresas em Acrílico					
Composição 31 fresas					
Ø 12,13,14,15,16,17,18,19,20,21,22,23,24,25,26,27,28,29,30,31,32,33,34,35,36,37,38,39,40, 45, 50					
(1 fresa de cada medida) OFERTA EXPOSITOR	<table border="1"> <thead> <tr> <th>CÓDIGO</th> <th>€</th> </tr> </thead> <tbody> <tr> <td>MFJPM12</td> <td>598,40</td> </tr> </tbody> </table>	CÓDIGO	€	MFJPM12	598,40
CÓDIGO	€				
MFJPM12	598,40				



Mala de Fresas	
Composição 8 peças	
Ø	UN
16	1
18	1
20	1
22	1
25	1
30	1
32	1
35	1
CÓDIGO	€
MFJ001	143,15

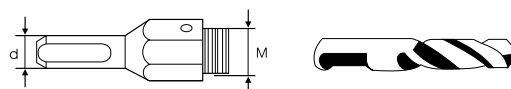

Adaptadores

CÓDIGO	Descrição	Ø	d	M	€
MFA12	Cabo	12 a 14	8	10 x 1,25	4,54
MFA15	Cabo	15 a 34	10	12 x 1,25	4,54
MFA50	Cabo	35 a 50	10	14 x 1,50	5,91
MFA51	Cabo	51 a 100	12	16 x 1,50	6,82
MFB12	Broca	12 a 100	6x52		2,01

FRESAS PERFURADORAS RETIFICADAS E JOGOS EM HSS REVESTIDAS A TIN

TIN COATED HOLE CUTTERS

FRAISES DE PERÇAGE HSS RECTIFIÉES ET REVÊTUES DE TIN



Para furar todo o material metálico em especial aço inox até 8mm de espessura



CÓDIGO	Ø	PCS	€	CÓDIGO	Ø	PCS	€
MFPT12	12	1	23,50	MFPT40	40	1	46,04
MFPT13	13	1	23,50	MFPT41	41	1	51,09
MFPT14	14	1	23,50	MFPT42	42	1	51,09
MFPT15	15	1	23,50	MFPT43	43	1	53,14
MFPT16	16	1	25,88	MFPT44	44	1	53,14
MFPT17	17	1	25,88	MFPT45	45	1	56,02
MFPT18	18	1	25,88	MFPT46	46	1	56,02
MFPT19	19	1	25,88	MFPT47	47	1	56,02
MFPT20	20	1	25,88	MFPT48	48	1	60,30
MFPT21	21	1	28,31	MFPT49	49	1	60,30
MFPT22	22	1	28,31	MFPT50	50	1	60,30
MFPT23	23	1	30,64	MFPT51	51	1	65,07
MFPT24	24	1	30,64	MFPT52	52	1	65,07
MFPT25	25	1	30,64	MFPT53	53	1	65,07
MFPT26	26	1	32,99	MFPT54	54	1	65,07
MFPT27	27	1	32,99	MFPT55	55	1	65,07
MFPT28	28	1	32,99	MFPT56	56	1	66,95
MFPT29	29	1	32,99	MFPT57	57	1	66,95
MFPT30	30	1	34,03	MFPT58	58	1	66,95
MFPT31	31	1	34,03	MFPT59	59	1	66,95
MFPT32	32	1	34,03	MFPT60	60	1	66,95
MFPT33	33	1	34,03				
MFPT34	34	1	34,03				
MFPT35	35	1	34,03				
MFPT36	36	1	41,28				
MFPT37	37	1	41,28				
MFPT38	38	1	41,28				
MFPT39	39	1	46,04				

Expositor de Fresas em Acrílico	
Composição 21 fresas	
Ø 18,19,20,21,22,23,24,25,26,27,28,29,30,31,32,33,34,35,36,38,40	
(1 fresa de cada medida)	CÓDIGO €
OFERTA EXPOSITOR	MFJPT18 690,93

Expositor de Fresas em Acrílico	
Composição 31 fresas	
Ø 12,13,14,15,16,17,18,19,20,21,22,23,24,25,26,27,28,29,30,31,32,33,34,35,36,37,38,39,40, 45, 50	
(1 fresa de cada medida)	CÓDIGO €
OFERTA EXPOSITOR	MFJPT12 990,79



Mala de Fresas	
Composição 8 peças	
Ø	UN
16	1
18	1
20	1
22	1
25	1
30	1
32	1
35	1
CÓDIGO	€
MFJ002	238,72

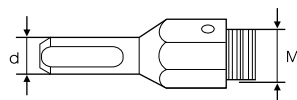

Adaptadores

CÓDIGO	Descrição	Ø	d	M	€
MFA12	Cabo	12 a 14	8	10 x 1,25	4,54
MFA15	Cabo	15 a 34	10	12 x 1,25	4,54
MFA50	Cabo	35 a 50	10	14 x 1,50	5,91
MFA51	Cabo	51 a 100	12	16 x 1,50	6,82
MFB12	Broca	12 a 100	6x52		2,01

FRESAS PERFURADORAS RETIFICADAS E JOGOS EM HSS REVESTIDAS A TIALN

TIALN COATED HOLE CUTTERS

FRAISES DE PERÇAGE HSS RECTIFIÉES ET REVÊTUES DE TIALN

TIALN



23 MM

Para furar aço, ferro, liga leve e todo o tipo de material metálico até 8mm de espessura, especial para inox



TIALN



Aço Inox



Fundição



CÓDIGO	Ø	PCS	€	CÓDIGO	Ø	PCS	€
MFPTI12	12	1	26,21	MFPTI40	40	1	47,37
MFPTI13	13	1	26,21	MFPTI41	41	1	53,06
MFPTI14	14	1	26,21	MFPTI42	42	1	53,06
MFPTI15	15	1	26,21	MFPTI43	43	1	54,96
MFPTI16	16	1	28,42	MFPTI44	44	1	54,96
MFPTI17	17	1	28,42	MFPTI45	45	1	58,11
MFPTI18	18	1	28,42	MFPTI46	46	1	58,11
MFPTI19	19	1	29,68	MFPTI47	47	1	58,11
MFPTI20	20	1	29,68	MFPTI48	48	1	62,54
MFPTI21	21	1	30,83	MFPTI49	49	1	62,54
MFPTI22	22	1	30,83	MFPTI50	50	1	62,54
MFPTI23	23	1	33,03	MFPTI51	51	1	66,43
MFPTI24	24	1	33,03	MFPTI52	52	1	66,43
MFPTI25	25	1	33,03	MFPTI53	53	1	66,43
MFPTI26	26	1	35,25	MFPTI54	54	1	66,43
MFPTI27	27	1	35,25	MFPTI55	55	1	66,43
MFPTI28	28	1	35,25	MFPTI56	56	1	67,54
MFPTI29	29	1	35,25	MFPTI57	57	1	67,54
MFPTI30	30	1	36,63	MFPTI58	58	1	67,54
MFPTI31	31	1	36,63	MFPTI59	59	1	67,54
MFPTI32	32	1	36,63	MFPTI60	60	1	67,54
MFPTI33	33	1	36,63				
MFPTI34	34	1	36,63				
MFPTI35	35	1	36,63				
MFPTI36	36	1	42,95				
MFPTI37	37	1	42,95				
MFPTI38	38	1	42,95				
MFPTI39	39	1	47,37				

Expositor de Fresas em Acrílico					
Composição 21 fresas					
Ø 18,19,20,21,22,23,24,25,26,27,28,29,30,31,32,33,34,35,36,38,40					
(1 fresa de cada medida) OFERTA EXPOSITOR	<table border="1"> <thead> <tr> <th>CÓDIGO</th> <th>€</th> </tr> </thead> <tbody> <tr> <td>MFJPTI21</td> <td>707,22</td> </tr> </tbody> </table>	CÓDIGO	€	MFJPTI21	707,22
CÓDIGO	€				
MFJPTI21	707,22				

Expositor de Fresas em Acrílico					
Composição 31 fresas					
Ø 12,13,14,15,16,17,18,19,20,21,22,23,24,25,26,27,28,29,30,31,32,33,34,35,36,37,38,39,40, 45, 50					
(1 fresa de cada medida) OFERTA EXPOSITOR	<table border="1"> <thead> <tr> <th>CÓDIGO</th> <th>€</th> </tr> </thead> <tbody> <tr> <td>MFJPTI31</td> <td>1062,11</td> </tr> </tbody> </table>	CÓDIGO	€	MFJPTI31	1062,11
CÓDIGO	€				
MFJPTI31	1062,11				



Mala de Fresas	
Composição 8 peças	
Ø	UN
16	1
18	1
20	1
22	1
25	1
30	1
32	1
35	1
CÓDIGO	€
MFJ003	245,78

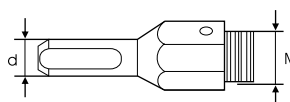

Adaptadores

CÓDIGO	Descrição	Ø	d	M	€
MFA12	Cabo	12 a 14	8	10 x 1,25	4,54
MFA15	Cabo	15 a 34	10	12 x 1,25	4,54
MFA50	Cabo	35 a 50	10	14 x 1,50	5,91
MFA51	Cabo	51 a 100	12	16 x 1,50	6,82
MFB12	Broca	12 a 100	6x52		2,01

FRESAS PERFURADORAS TCT COM DENTES EM METAL DURO (PARA INOX) E JOGOS

WELDON SHANK CARBIDE TIP CORE DRILLS FOR MAGNETIC MACHINES

FRAISES DE PERÇAGE TCT AVEC DENTS EN MÉTAL DUR (POUR L'ACIER INOXYDABLE)



CÓDIGO	Ø	PCS	€	CÓDIGO	Ø	PCS	€
MFPMD15	15	1	37,36	MFPMD50	50	1	84,16
MFPMD16	16	1	37,36	MFPMD51	51	1	94,74
MFPMD17	17	1	37,36	MFPMD52	52	1	94,74
MFPMD18	18	1	37,36	MFPMD53	53	1	94,74
MFPMD19	19	1	38,98	MFPMD54	54	1	94,74
MFPMD20	20	1	38,98	MFPMD55	55	1	94,74
MFPMD21	21	1	38,98	MFPMD56	56	1	113,69
MFPMD22	22	1	38,98	MFPMD57	57	1	113,69
MFPMD23	23	1	39,79	MFPMD58	58	1	113,69
MFPMD24	24	1	39,79	MFPMD59	59	1	113,69
MFPMD25	25	1	39,79	MFPMD60	60	1	127,77
MFPMD26	26	1	46,94	MFPMD65	65	1	127,77
MFPMD27	27	1	46,94	MFPMD70	70	1	154,30
MFPMD28	28	1	46,94	MFPMD75	75	1	165,13
MFPMD29	29	1	46,94	MFPMD80	80	1	178,67
MFPMD30	30	1	46,94	MFPMD85	85	1	197,62
MFPMD31	31	1	54,68	MFPMD90	90	1	213,85
MFPMD32	32	1	54,68	MFPMD95	95	1	224,96
MFPMD33	33	1	54,68	MFPMD100	100	1	243,64
MFPMD34	34	1	54,68	MFPMD105	105	1	252,29
MFPMD35	35	1	54,68	MFPMD110	110	1	30,24
MFPMD36	36	1	63,36	MFPMD115	115	1	322,13
MFPMD37	37	1	63,36	MFPMD120	120	1	1,47
MFPMD38	38	1	63,36				
MFPMD39	39	1	63,36				
MFPMD40	40	1	63,36				
MFPMD41	41	1	72,55				
MFPMD42	42	1	72,55				
MFPMD43	43	1	72,55				
MFPMD44	44	1	72,55				
MFPMD45	45	1	72,55				
MFPMD46	46	1	84,16				
MFPMD47	47	1	84,16				
MFPMD48	48	1	84,16				
MFPMD49	49	1	84,16				

Expositor de Fresas em Acrílico					
Composição 21 fresas					
Ø 18,19,20,21,22,23,24,25,26,27,28,29,30,31,32,33,34,35,36,38,40					
(1 fresa de cada medida) OFERTA EXPOSITOR	<table border="1"> <thead> <tr> <th>CÓDIGO</th> <th>€</th> </tr> </thead> <tbody> <tr> <td>MFJMD18</td> <td>1010,77</td> </tr> </tbody> </table>	CÓDIGO	€	MFJMD18	1010,77
CÓDIGO	€				
MFJMD18	1010,77				

Expositor de Fresas em Acrílico					
Composição 31 fresas					
Ø 15,16,17,18,19,20,21,22,23,24,25,26,27,28,29,30,31,32,33,34,35,36,37,38,39,40, 45, 50					
(1 fresa de cada medida) OFERTA EXPOSITOR	<table border="1"> <thead> <tr> <th>CÓDIGO</th> <th>€</th> </tr> </thead> <tbody> <tr> <td>MFJMD15</td> <td>1406,29</td> </tr> </tbody> </table>	CÓDIGO	€	MFJMD15	1406,29
CÓDIGO	€				
MFJMD15	1406,29				



Mala de Fresas	
Composição 8 peças	
Ø	UN
16	1
18	1
20	1
22	1
25	1
30	1
32	1
35	1
CÓDIGO	€
MFJ004	348,77

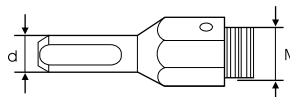

Adaptadores

CÓDIGO	Descrição	Ø	d	M	€
MFAMD15	Cabo	12 a 14	8	10 x 1,25	6,49
MFAMD22	Cabo	15 a 34	10	12 x 1,25	7,88
MFAMD39	Cabo	35 a 50	10	14 x 1,50	9,74
MFB15	Cabo	51 a 100	12	16 x 1,50	6,49
MFB105	Broca	12 a 100	6x52		9,32

FRESAS ROTATIVAS EM METAL DURO HM-4 E HM-3 (CABO Ø 6mm)

HM-4 AND HM-3 HARD METAL ROTARY MILLS (SHANK Ø 6mm)

FRAISES ROTATIFS EN MÉTAL DUR HM-4 ET HM-3 (CÂBLE Ø 6 mm)

METAL DURO

HM-4

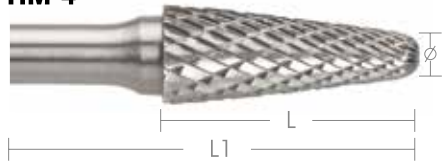

Corte Cruzado:

para aço tratado, aço inox e materiais metálicos em geral



METAL DURO

HM-3



Corte Standard:

para aço, alumínio e materiais plásticos



CÓDIGO	Ø	x	L	x	L'	PCS	€
MFR100	6	x	18	x	50	1	15,34
MFR101	8	x	18	x	63	1	18,93
MFR102	10	x	20	x	65	1	23,49
MFR103	12	x	25	x	70	1	29,73
MFR104	16	x	25	x	70	1	44,10
MFR105	6	x	18	x	50	1	15,34
MFR106	8	x	18	x	63	1	18,93
MFR107	10	x	20	x	65	1	23,49
MFR108	12	x	25	x	70	1	29,73
MFR109	16	x	25	x	70	1	44,10
MFR110	6	x	18	x	50	1	15,34
MFR111	8	x	18	x	63	1	18,93
MFR112	10	x	20	x	65	1	23,49
MFR113	12	x	25	x	70	1	29,73
MFR114	16	x	25	x	70	1	44,10
MFR115	6	x	18	x	50	1	15,34
MFR116	8	x	18	x	63	1	18,93
MFR117	10	x	20	x	65	1	23,49
MFR118	12	x	25	x	70	1	29,73
MFR119	16	x	25	x	70	1	44,10
MFR120	6	x	18	x	50	1	15,34
MFR121	8	x	18	x	63	1	18,93
MFR122	10	x	20	x	65	1	23,49
MFR123	12	x	25	x	70	1	29,73
MFR124	16	x	25	x	70	1	44,10
MFR125	6	x	18	x	50	1	15,34
MFR126	8	x	18	x	63	1	18,93
MFR127	10	x	20	x	65	1	23,49
MFR128	12	x	25	x	70	1	29,73
MFR129	16	x	25	x	70	1	44,10
MFR130	6	x	18	x	50	1	15,34
MFR131	8	x	18	x	63	1	18,93
MFR132	10	x	16	x	65	1	23,49
MFR133	12	x	25	x	70	1	29,73
MFR134	16	x	25	x	70	1	44,10
MFR135	6	x	5	x	50	1	15,34
MFR136	8	x	7	x	63	1	18,93
MFR137	10	x	9	x	65	1	23,49
MFR138	12	x	10	x	70	1	29,73
MFR139	16	x	14	x	55	1	44,10

HM-4

Cilíndrica	Tipo A	
Cilíndrica Esférica	Tipo B	
Ogiva em Ponta	Tipo C	
Ogiva Arredondada	Tipo D	
Cônica em Bico	Tipo E	
Cônica com Ponta Arredondada	Tipo F	
Gota	Tipo G	
Esférica	Tipo H	

CÓDIGO	Ø	x	L	x	L'	PCS	€
MFR140	6	x	18	x	50	1	15,29
MFR141	8	x	18	x	63	1	18,78
MFR142	10	x	20	x	65	1	23,25
MFR143	12	x	25	x	70	1	29,43
MFR144	16	x	25	x	70	1	43,66
MFR145	6	x	18	x	50	1	15,29
MFR146	8	x	18	x	63	1	18,78
MFR147	10	x	20	x	65	1	23,25
MFR148	12	x	25	x	70	1	29,43
MFR149	16	x	25	x	70	1	43,66
MFR150	6	x	18	x	50	1	15,29
MFR151	8	x	18	x	63	1	18,78
MFR152	10	x	20	x	65	1	23,25
MFR153	12	x	25	x	70	1	29,43
MFR154	16	x	25	x	70	1	43,66
MFR155	6	x	18	x	50	1	15,29
MFR156	8	x	18	x	63	1	18,78
MFR157	10	x	20	x	65	1	23,25
MFR158	12	x	25	x	70	1	29,43
MFR159	16	x	25	x	70	1	43,66
MFR160	6	x	18	x	50	1	15,29
MFR161	8	x	18	x	63	1	18,78
MFR162	10	x	20	x	65	1	23,25
MFR163	12	x	25	x	70	1	29,43
MFR164	16	x	25	x	70	1	43,66
MFR165	6	x	18	x	50	1	15,29
MFR166	8	x	18	x	63	1	18,78
MFR167	10	x	20	x	65	1	23,25
MFR168	12	x	25	x	70	1	29,43
MFR169	16	x	25	x	70	1	43,66
MFR170	6	x	18	x	50	1	15,29
MFR171	8	x	18	x	63	1	18,78
MFR172	10	x	16	x	65	1	23,25
MFR173	12	x	25	x	70	1	29,43
MFR174	16	x	25	x	70	1	43,66
MFR175	6	x	5	x	50	1	15,29
MFR176	8	x	7	x	63	1	18,78
MFR177	10	x	9	x	65	1	23,25
MFR178	12	x	10	x	70	1	29,43
MFR179	16	x	14	x	70	1	43,76

FRESAS ROTATIVAS EM HSS (CABO Ø 6mm)

ROTARY MILLS IN HSS (SHANK Ø 6mm)
 FRAISES ROTATIVAS HSS (CÂBLE Ø 6mm)

HSS

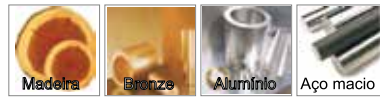

Utilização: corte de madeira macia, bronze, aço macio e alumínio

CÓDIGO	Ø	x	L	PCS	€
MFR200	6	x	20	1	8,34
MFR201	8	x	30	1	10,58
MFR202	10	x	30	1	12,23
MFR203	12	x	30	1	12,96
MFR204	15	x	30	1	16,27
MFR205	6	x	20	1	8,34
MFR206	8	x	30	1	10,58
MFR207	10	x	30	1	12,23
MFR208	12	x	30	1	12,96
MFR209	15	x	30	1	16,27
MFR210	6	x	20	1	8,34
MFR211	8	x	30	1	10,58
MFR212	10	x	30	1	12,23
MFR213	12	x	30	1	12,96
MFR214	15	x	30	1	16,27
MFR215	6	x	20	1	8,34
MFR216	8	x	30	1	10,58
MFR217	10	x	30	1	12,23
MFR218	12	x	30	1	12,96
MFR219	15	x	30	1	16,27
MFR220	6	x	5	1	8,34
MFR221	8	x	7	1	10,58
MFR222	10	x	9	1	12,23
MFR223	12	x	10	1	12,96
MFR224	15	x	14	1	16,27



HSS



Jogos em Acrílico HSS					
Composição 10 fresas					
TIPO	Ø	UN	TIPO	Ø	UN
A	6 x 20	1	C	10 x 30	1
A	10 x 30	1	D	6 x 20	1
B	6 x 20	1	D	10 x 30	1
B	10 x 30	1	H	6 x 5	1
C	6 x 20	1	H	10 x 9	1

OFERTA EXPOSITOR

CÓDIGO	€
MFRE06	102,88

JOGOS DE MACHOS MANUAIS HSS

HSS HAND TAPS SETS

JEUX DE TARAUDS À MAIN HSS

HSS



Machos n°1 - Cónico



Machos n°2 - 1/2 Cónico



Machos n°3 - Direito

M

DIN
352

HSS



Jogo de 3

HSS



Machos n°1 - Cónico



Machos n°3 - Direito

MF

DIN
2181

HSS



Jogo de 2

Rosca Métrica HSS DIN352

CÓDIGO	Medida	l mm	L mm	PCS	€
MJP550	M 2 x 0,40	10	36	3	12,48
MJP551	M 2,5 x 0,45	12	40	3	13,81
MJP552	M 3 x 0,50	12	40	3	7,95
MJP553	M 4 x 0,70	14	45	3	7,95
MJP554	M 5 x 0,80	14	50	3	8,47
MJP555	M 6 x 1,00	16	56	3	9,48
MJP578	M 7 x 1,00	19	50	3	14,02
MJP556	M 8 x 1,25	18	63	3	11,16
MJP579	M 9 x 1,25	22	63	3	16,71
MJP557	M 10 x 1,50	25	70	3	14,27
MJP558	M 12 x 1,75	30	75	3	18,39
MJP559	M 14 x 2,00	32	80	3	23,86
MJP560	M 16 x 2,00	32	80	3	28,25
MJP561	M 18 x 2,50	40	95	3	40,66
MJP562	M 20 x 2,50	40	95	3	48,92
MJP563	M 22 x 2,50	40	100	3	57,75
MJP564	M 24 x 3,00	50	110	3	67,37
MJP565	M 27 x 3,00	50	110	3	88,97
MJP566	M 30 x 3,50	50	125	3	113,78
MJP567	M 33 x 3,50	50	132	3	142,85
MJP568	M 36 x 4,00	56	150	3	168,51
MJP569	M 39 x 4,00	56	150	3	272,88
*MJP570	M 42 x 4,50	63	160	3	318,95
*MJP571	M 45 x 4,50	63	160	3	406,02
*MJP572	M 48 x 5,00	68	180	3	568,24
*MJP573	M 52 x 5,00	68	180	3	584,75
*MJP574	M 56 x 5,50	85	200	3	826,67
*MJP575	M 60 x 5,50	85	200	3	920,20
*MJP576	M 64 x 6,00	90	220	3	974,27
*MJP577	M 68 x 6,00	90	220	3	1083,34

* entrega sob consulta

Rosca Métrica Fina DIN2181

CÓDIGO	Medida	l mm	L mm	PCS	€
MJP650	M 4 x 0,50	10	45	2	12,84
MJP651	M 5 x 0,50	12	50	2	13,66
MJP652	M 6 x 0,75	14	50	2	11,77
MJP653	M 8 x 1,00	22	56	2	12,31
MJP654	M 10 x 1,00	20	63	2	16,31
MJP655	M 10 x 1,25	20	63	2	16,31
MJP656	M 12 x 1,00	22	70	2	19,32
MJP657	M 12 x 1,25	22	70	2	16,31
MJP658	M 12 x 1,50	22	70	2	16,31
MJP659	M 13 x 1,00	22	70	2	33,45
MJP660	M 14 x 1,00	22	70	2	19,57
MJP661	M 14 x 1,25	22	70	2	19,57
MJP662	M 14 x 1,50	22	70	2	19,57
MJP663	M 16 x 1,00	22	70	2	21,85
MJP664	M 16 x 1,50	22	70	2	21,85
MJP665	M 18 x 1,00	22	80	2	30,87
MJP666	M 18 x 1,50	22	80	2	30,87
MJP667	M 20 x 1,50	22	80	2	34,08
MJP668	M 20 x 2,00	22	80	2	34,08
MJP669	M 22 x 1,00	22	80	2	41,20
MJP670	M 22 x 1,50	22	80	2	41,20
MJP671	M 24 x 1,50	22	90	2	48,33
MJP672	M 24 x 2,00	22	90	2	48,33
MJP673	M 25 x 1,50	22	90	2	74,64
MJP674	M 26 x 1,50	22	90	2	74,64
MJP675	M 27 x 1,50	22	90	2	71,68
MJP676	M 27 x 2,00	22	90	2	71,68
MJP677	M 30 x 1,50	22	90	2	97,53
MJP678	M 30 x 2,00	22	90	2	97,53



JOGOS DE MACHOS MANUAIS EM HSS, HSS-CO E TIN

HSS HAND TAPS SETS

JEUX DE TARAUDS À MAIN HSS, HSS-CO ET TIN

HSS-CO



Macho nº1 - Cónico



Macho nº2 - 1/2 Cónico



Macho nº3 - Direito

M

DIN
352

HSS-CO
VAPO



Jogo de 3

Rosca Métrica HSS-CO Vapo para Inox

CÓDIGO	Medida	l mm	L mm	PCS	€
MJ120	M 3 x 0,50	11	40	3	17,86
MJ121	M 4 x 0,70	13	45	3	19,57
MJ122	M 5 x 0,80	16	50	3	25,47
MJ123	M 6 x 1,00	19	50	3	25,47
MJ124	M 8 x 1,25	22	56	3	28,51
MJ125	M 10 x 1,50	24	70	3	39,73
MJ126	M 12 x 1,75	29	75	3	46,38
MJ127	M 14 x 2,00	30	80	3	50,37
MJ128	M 16 x 2,00	32	80	3	65,97
MJ129	M 18 x 2,50	40	95	3	82,30
MJ130	M 20 x 2,50	40	95	3	95,04

TIN



Macho nº1 - Cónico



Macho nº2 - 1/2 Cónico



Macho nº3 - Direito

M

DIN
352

TIN



Jogo de 3

Rosca Métrica TIN para Inox

CÓDIGO	Medida	l mm	L mm	PCS	€
MJ150	M 3 x 0,50	11	40	3	41,17
MJ151	M 4 x 0,70	13	45	3	42,22
MJ152	M 5 x 0,80	16	50	3	43,15
MJ153	M 6 x 1,00	19	50	3	43,23
MJ154	M 8 x 1,25	22	56	3	51,95
MJ155	M 10 x 1,50	24	70	3	61,72
MJ156	M 12 x 1,75	29	75	3	94,85
MJ157	M 14 x 2,00	30	80	3	112,89
MJ158	M 16 x 2,00	32	80	3	140,97

HSS



Macho nº1 - Cónico



Macho nº2 - 1/2 Cónico



Macho nº3 - Direito

Rosca
Esquerda

DIN
352

HSS



Jogo de 3

Rosca Esquerda HSS

CÓDIGO	Medida	l mm	L mm	PCS	€
MJP900	M 3 x 0,50	11	40	3	13,11
MJP902	M 4 x 0,70	13	45	3	13,50
MJP904	M 5 x 0,80	16	50	3	15,97
MJP906	M 6 x 1,00	19	50	3	16,49
MJP908	M 8 x 1,25	22	56	3	17,60
MJP910	M 10 x 1,50	24	70	3	23,12
MJP912	M 12 x 1,75	29	75	3	30,78
MJP913	M 14 x 2,00	30	80	3	46,20
MJP914	M 16 x 2,00	32	80	3	51,10
MJP915	M 18 x 2,50	40	95	3	54,36
MJP916	M 20 x 2,50	40	95	3	59,97
MJP917	M 22 x 2,50	40	100	3	67,71
MJP918	M 24 x 3,00	50	110	3	85,33
MJP919	M 27 x 3,00	50	110	3	232,91
MJP920	M 30 x 3,50	56	125	3	288,42

HSS



Macho nº1 - Cónico



Macho nº2 - 1/2 Cónico



Macho nº3 - Direito

BSW

DIN
352

HSS



Jogo de 3

Rosca BSW HSS

CÓDIGO	Medida	l mm	L mm	PCS	€
MJP760	1/8 x 40	12	40	3	16,53
MJP761	5/32 x 32	14	45	3	16,53
MJP762	3/16 x 24	14	45	3	16,53
MJP775	7/32 x 24	18	50	3	16,53
MJP763	1/4 x 20	22	56	3	16,53
MJP764	5/16 x 18	22	56	3	17,46
MJP765	3/8 x 16	25	70	3	18,84
MJP766	7/16 x 14	30	75	3	24,71
MJP767	1/2 x 12	30	75	3	29,81
MJP768	9/16 x 12	32	80	3	41,39
MJP769	5/8 x 11	32	80	3	49,58
MJP770	3/4 x 10	40	95	3	66,10
MJP771	7/8 x 9	40	100	3	77,22
MJP772	1" x 8	50	110	3	77,22
MJP773	1" 1/4 x 7	56	132	3	251,68
MJP774	1" 1/2 x 6	63	150	3	366,08



JOGOS DE MACHOS MANUAIS BSP (GAS), UNC E UNF-SAE EM HSS

HSS HAND TAPS SETS

JEUX DE TARAUDS POUR MACHINE À FILETAGE BSP (GAZ), UNC ET UNF-SAE EN HSS

HSS



Machete n°1 - Cónico



Machete n°3 - Direito

GAS
BSP

DIN
5157

HSS



Jogo de 2

Rosca GAS BSP HSS

CÓDIGO	Medida	I mm	L mm	PCS	€
MJP500	G 1/8 x 28	20	63	2	14,86
MJP501	G 1/4 x 19	20	70	2	16,85
MJP502	G 3/8 x 19	22	70	2	21,79
MJP503	G 1/2 x 14	22	80	2	36,50
MJP504	G 5/8 x 14	22	80	2	55,25
MJP505	G 3/4 x 14	22	90	2	54,62
MJP506	G 7/8 x 14	22	90	2	94,79
MJP507	G 1" x 11	25	100	2	87,62
MJP508	G 1"1/8 x 11	40	125	2	128,88
MJP509	G 1"1/4 x 11	40	125	2	134,70
MJP511	G 1"1/2 x 11	40	140	2	183,11
MJP512	G 1"3/4 x 11	40	140	2	325,55
MJP513	G 2" x 11	40	160	2	325,55

HSS



Machete n°1 - Cónico



Machete n°2 - 1/2 Cónico



Machete n°3 - Direito

UNC

DIN
352

HSS



Jogo de 3

Rosca UNC HSS

CÓDIGO	Medida	I mm	L mm	PCS	€
MJP455	UNC 1/4 x 20	19	50	3	21,09
MJP456	UNC 5/16 x 18	22	56	3	22,90
MJP457	UNC 3/8 x 16	24	70	3	24,05
MJP458	UNC 7/16 x 14	24	70	3	38,23
MJP459	UNC 1/2 x 13	29	75	3	38,23
MJP460	UNC 9/16 x 12	30	80	3	53,21
MJP461	UNC 5/8 x 11	32	80	3	76,93
MJP462	UNC 3/4 x 10	40	95	3	89,29
MJP463	UNC 7/8 x 9	40	100	3	89,29
MJP464	UNC 1" x 8	50	110	3	89,29

HSS



Machete n°1 - Cónico



Machete n°3 - Direito

UNF

DIN
352

HSS



Jogo de 2

Rosca UNF-SAE HSS

CÓDIGO	Medida	I mm	L mm	PCS	€
MJP400	UNF 1/4 x 28	18	50	2	16,23
MJP401	UNF 5/16 x 24	22	56	2	17,62
MJP402	UNF 3/8 x 24	22	63	2	18,62
MJP403	UNF 7/16 x 20	18	63	2	24,46
MJP404	UNF 1/2 x 20	30	75	2	29,40
MJP405	UNF 9/16 x 18	32	80	2	29,40
MJP406	UNF 5/8 x 18	32	80	2	35,10
MJP407	UNF 3/4 x 16	40	95	2	47,15
MJP408	UNF 7/8 x 14	40	100	2	62,98
MJP409	UNF 1" x 12	22	90	2	62,98



MACHOS MANUAIS ROSCA MÉTRICA HSS E ROSCA BSW / WHITWORTH HSS

HSS METRIC THREAD AND BSW WHITWORTH THREAD HAND TAPS

TARAUDS À MAIN À FILETAGE MÉTRIQUE HSS ET À FILETAGE HSS BSW / WHITWORTH

HSS



Machos n°1
Cónico



Machos n°2
1/2 Cónico



Machos n°3
Direito

Rosca Métrica HSS DIN352

Medida	I mm	L mm	PCS	CÓDIGO	€	CÓDIGO	€	CÓDIGO	€
M 2 x 0,40	10	36	1	MJPA001	4,36	MJPA025	4,36	MJPA050	4,36
M 2,5 x 0,45	12	40	1	MJPA002	4,82	MJPA026	4,82	MJPA051	4,82
M 3 x 0,50	12	40	1	MJPA003	3,10	MJPA027	3,10	MJPA052	3,10
M 4 x 0,70	14	45	1	MJPA005	3,25	MJPA029	3,25	MJPA054	3,25
M 5 x 0,80	14	50	1	MJPA006	3,26	MJPA030	3,26	MJPA055	3,26
M 6 x 1,00	16	56	1	MJPA007	3,40	MJPA031	3,40	MJPA056	3,40
M 7 x 1,00	19	50	1	MJPA008	3,75	MJPA032	3,75	MJPA057	3,75
M 8 x 1,25	18	63	1	MJPA009	3,91	MJPA033	3,91	MJPA058	3,91
M 9 x 1,25	22	63	1	MJPA010	5,57	MJPA034	4,69	MJPA059	5,57
M 10 x 1,50	25	70	1	MJPA011	4,98	MJPA035	4,98	MJPA060	4,98
M 12 x 1,75	30	75	1	MJPA013	6,41	MJPA037	6,41	MJPA062	6,41
M 14 x 2,00	32	80	1	MJPA014	8,33	MJPA038	8,33	MJPA063	8,33
M 16 x 2,00	32	80	1	MJPA015	9,86	MJPA039	9,86	MJPA064	9,86
M 18 x 2,50	40	95	1	MJPA016	15,82	MJPA040	15,82	MJPA065	15,82
M 20 x 2,50	40	95	1	MJPA017	17,08	MJPA041	17,08	MJPA066	17,08
M 22 x 2,50	40	100	1	MJPA018	20,17	MJPA042	20,17	MJPA067	20,17
M 24 x 3,00	50	110	1	MJPA019	23,52	MJPA043	23,52	MJPA068	23,52
M 27 x 3,00	50	110	1	MJPA020	31,08	MJPA044	31,08	MJPA069	31,08
M 30 x 3,50	50	125	1	MJPA021	39,73	MJPA045	39,73	MJPA070	39,73

M

DIN
352

HSS



Machos n°1
Cónico



Machos n°2
1/2 Cónico



Machos n°3
Direito

Rosca BSW / Whitworth HSS

Medida	I mm	L mm	PCS	CÓDIGO	€	CÓDIGO	€	CÓDIGO	€
W 1/8 x 40	12	40	1	MJPA075	5,50	MJPA095	5,50	MJPA115	5,50
W 5/32 x 32	14	45	1	MJPA076	5,50	MJPA096	5,50	MJPA116	5,50
W 3/16 x 24	14	45	1	MJPA077	5,50	MJPA097	5,50	MJPA117	5,50
W 7/32 x 24	18	50	1	MJPA078	5,50	MJPA098	5,50	MJPA118	5,50
W 1/4 x 20	22	56	1	MJPA079	5,50	MJPA099	5,50	MJPA119	5,50
W 5/16 x 18	22	56	1	MJPA080	5,81	MJPA100	5,81	MJPA120	5,81
W 3/8 x 16	25	70	1	MJPA081	6,28	MJPA101	6,28	MJPA121	6,28
W 7/16 x 14	30	75	1	MJPA082	8,24	MJPA102	8,24	MJPA122	8,24
W 1/2 x 12	30	75	1	MJPA083	9,93	MJPA103	9,93	MJPA123	9,93
W 9/16 x 12	32	80	1	MJPA084	13,79	MJPA104	13,79	MJPA124	13,79
W 5/8 x 11	32	80	1	MJPA085	16,52	MJPA105	16,52	MJPA125	16,52
W 3/4 x 10	40	95	1	MJPA086	22,03	MJPA106	22,03	MJPA126	22,03
W 7/8 x 9	40	100	1	MJPA087	25,74	MJPA107	25,74	MJPA127	25,74
W 1" x 8	50	110	1	MJPA088	25,74	MJPA108	25,74	MJPA128	25,74
W 1"1/4 x 7	56	132	1	MJPA089	83,89	MJPA109	83,89	MJPA129	83,89
W 1"1/2 x 6	63	150	1	MJPA090	122,02	MJPA110	122,02	MJPA130	122,02

BSW

DIN
352

HSS



MACHOS PARA MÁQUINA ROSCA MÉTRICA EM HSS DIN371/376

HSS MACHINE TAPS WITH METRIC THREAD DIN371/376

TARAUDS POUR MACHINES À FILETAGE MÉTRIQUES HSS DIN371/376

HSS



HSS

DIN
371/376

Forma B

Navalhas Direitas DIN371/376 HSS

CÓDIGO	Medida	I mm	L mm	PCS	€
DIN371					
MJP600	M 3 x 0,50	11	56	1	4,12
MJP601	M 4 x 0,70	13	63	1	4,12
MJP602	M 5 x 0,80	16	70	1	4,46
MJP603	M 6 x 1,00	19	80	1	4,46
MJP604	M 8 x 1,25	22	90	1	5,53
MJP605	M 10 x 1,50	24	100	1	7,20
DIN376					
MJP606	M 12 x 1,75	29	110	1	9,98
MJP607	M 14 x 2,00	30	110	1	11,92
MJP608	M 16 x 2,00	32	110	1	12,14
MJP609	M 18 x 2,50	34	125	1	16,89
MJP610	M 20 x 2,50	34	140	1	22,34
MJP611	M 22 x 2,50	34	140	1	26,86
MJP612	M 24 x 3,00	38	160	1	34,84
MJP613	M 27 x 3,00	45	135	1	49,36
MJP614	M 30 x 3,50	48	138	1	63,66



HSS

DIN
371/376

Forma B
35°

Navalhas Helicoidais DIN371/376 HSS

CÓDIGO	Medida	I mm	L mm	PCS	€
DIN371					
MJP720	M 3 x 0,50	11	56	1	6,99
MJP721	M 4 x 0,70	13	63	1	6,99
MJP722	M 5 x 0,80	16	70	1	7,11
MJP723	M 6 x 1,00	19	80	1	7,11
MJP724	M 8 x 1,25	22	90	1	8,43
MJP725	M 10 x 1,50	24	100	1	9,67
DIN376					
MJP726	M 12 x 1,75	29	110	1	11,48
MJP727	M 14 x 2,00	30	110	1	14,72
MJP728	M 16 x 2,00	32	110	1	16,61
MJP729	M 18 x 2,50	34	125	1	22,58
MJP730	M 20 x 2,50	34	140	1	28,34

HSS

DIN
371/376

Forma B



HSS

DIN
371/376

Forma B
35°



Jogo de Machos para Máquina Navalhas Direitas DIN371/376 HSS

Composição 7 machos (1 de cada medida)

Ø M3 - M4 - M5 - M6 - M8 - M10 - M12

CÓDIGO €
MJP690 42,17

Jogo de Machos para Máquina Navalhas Helicoidais DIN371/376 HSS

Composição 7 machos (1 de cada medida)

Ø M3 - M4 - M5 - M6 - M8 - M10 - M12

CÓDIGO €
MJP691 75,67



MACHOS PARA MÁQUINA ROSCA MÉTRICA EM HSS-CO DIN371/376

HSS-CO MACHINE TAPS WITH METRIC THREAD DIN371/376

TARAUDS POUR MACHINES À FILETAGE MÉTRIQUES HSS-CO DIN371/376

HSS-CO



HSS-CO

DIN
371/376

Forma B

Navalhas Direitas DIN371/376 HSS-CO

CÓDIGO	Medida	I mm	L mm	PCS	€
DIN371					
MMP001	M 3 x 0,50	11	56	1	6,48
MMP002	M 4 x 0,70	13	63	1	6,48
MMP003	M 5 x 0,80	16	70	1	7,81
MMP004	M 6 x 1,00	19	80	1	9,83
MMP005	M 8 x 1,25	22	90	1	11,54
MMP006	M 10 x 1,50	24	100	1	15,95
DIN376					
MMP007	M 12 x 1,75	29	110	1	18,95
MMP008	M 14 x 2,00	30	110	1	19,38
MMP009	M 16 x 2,00	32	110	1	24,59
MMP010	M 18 x 2,50	34	125	1	27,34
MMP011	M 20 x 2,50	34	140	1	30,47
MMP012	M 22 x 2,50	34	140	1	36,91
MMP013	M 24 x 3,00	38	160	1	46,84
MMP014	M 27 x 3,00	45	160	1	76,04
MMP015	M 30 x 3,50	48	180	1	92,80

HSS-CO

DIN
371/376

Forma B
35°



Navalhas Helicoidais DIN371/376 HSS-CO

CÓDIGO	Medida	I mm	L mm	PCS	€
DIN371					
MMP016	M 3 x 0,50	11	56	1	7,68
MMP017	M 4 x 0,70	13	63	1	7,68
MMP018	M 5 x 0,80	16	70	1	8,47
MMP019	M 6 x 1,00	19	80	1	10,63
MMP020	M 8 x 1,25	22	90	1	13,85
MMP021	M 10 x 1,50	24	100	1	18,72
DIN376					
MMP022	M 12 x 1,75	29	110	1	21,80
MMP023	M 14 x 2,00	30	110	1	21,93
MMP024	M 16 x 2,00	32	110	1	27,95
MMP025	M 18 x 2,50	34	125	1	31,09
MMP026	M 20 x 2,50	34	140	1	34,62

HSS-CO

DIN
371/376

Forma B



HSS-CO

DIN
371/376

Forma B
35°



Jogo de Machos para Máquina Navalhas Direitas DIN371/376 HSS-CO

Composição 7 machos (1 de cada medida)

Ø M3 - M4 - M5 - M6 - M8 - M10 - M12

CÓDIGO €
MJCM01 79,29

Jogo de Machos para Máquina Navalhas Helicoidais DIN371/376 HSS-CO

Composição 7 machos (1 de cada medida)

Ø M3 - M4 - M5 - M6 - M8 - M10 - M12

CÓDIGO €
MJCM02 88,66



MACHOS P/ MÁQUINA ROSCA BSW HSS-CO E ROSCA MÉTRICA TIN DIN371/376

HSS-CO BSW AND METRIC TIN MACHINE TAPS DIN371/376

TARAUDS POUR MACHINES À FILETAGE MÉTRIQUES BSW HSS-CO ET FILETAGE MÉTRIQUES TIN DIN371/376



HSS-CO	DIN 371/376	Forma B
--------	----------------	---------



TIN	DIN 371/376	Forma B
-----	----------------	---------

Rosca BSW / Whitworth Nav. Direitas HSS-CO

CÓDIGO	Medida	I mm	L mm	PCS	€
DIN371					
MMP100	W 8 x 40	11	56	1	23,36
MMP101	W 5/32 x 32	13	63	1	23,36
MMP102	W 3/16 x 24	15	70	1	23,97
MMP103	W 1/4 x 20	17	80	1	23,97
MMP104	W 5/16 x 18	20	90	1	29,52
MMP105	W 3/8 x 16	22	100	1	33,15
DIN376					
MMP106	W 7/16 x 14	22	110	1	35,72
MMP107	W 1/2 x 12	24	110	1	36,06
MMP108	W 9/16 x 12	26	110	1	53,31
MMP109	W 5/8 x 11	27	125	1	53,31
MMP110	W 3/4 x 10	30	140	1	110,44
MMP111	W 7/8 x 9	32	140	1	124,75
MMP112	W 1" x 8	36	160	1	141,68

Rosca Métrica Navalhas Direitas - TIN

CÓDIGO	Medida	I mm	L mm	PCS	€
DIN371					
MMT01	M 3 x 0,50	10	56	1	15,59
MMT02	M 4 x 0,70	12	63	1	15,59
MMT03	M 5 x 0,80	14	70	1	16,32
MMT04	M 6 x 1,00	19	80	1	16,32
MMT05	M 8 x 1,25	22	90	1	18,24
MMT06	M 10 x 1,50	24	100	1	23,02
DIN376					
MMT07	M 12 x 1,75	24	110	1	23,90
MMT08	M 14 x 2,00	26	110	1	52,66
MMT09	M 16 x 2,00	27	110	1	59,77
MMT10	M 18 x 2,50	30	125	1	72,51
MMT11	M 20 x 2,50	32	140	1	82,14



HSS-CO
DIN 371/376
Forma B



TIN
DIN 371/376
Forma B

Jogo de Machos para Máquina Rosca BSW Navalhas Direitas em HSS-CO
Composição 7 machos (1 de cada medida)
Ø 1/8 - 5/32 - 3/16 - 1/4 - 5/16 - 3/8 - 7/16

Jogo de Machos para Máquina Rosca Métrica Navalhas Direitas em TIN
Composição 7 machos (1 de cada medida)
Ø M 3, M 4, M 5, M 6, M 8, M 10, M 12

CÓDIGO	€
MJCM10	123,63

CÓDIGO	€
M JCM20	139,99

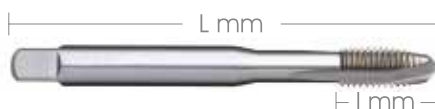

MACHOS PARA MÁQUINA ROSCA BSP (GAS) EM HSS-CO DIN5156

HSS-CO MACHINE TAPS BSP (GAS) THREAD DIN5156

TARAUDS POUR MACHINE À FILETAGE BSP (GAZ) EN HSS-CO DIN5156

HSS-CO



HSS-CO	DIN 5156	Forma B
--------	-------------	---------

Rosca BSP (GAS) Navalhas Direitas HSS-CO

CÓDIGO	Medida	l mm	L mm	PCS	€
MMP050	G 1/8 x 28	20	90	1	17,62
MMP051	G 1/4 x 19	20	100	1	20,39
MMP052	G 3/8 x 19	22	100	1	24,78
MMP053	G 1/2 x 14	25	140	1	41,64
MMP054	G 5/8 x 14	25	140	1	42,33
MMP055	G 3/4 x 14	30	140	1	62,40
MMP056	G 7/8 x 14	30	160	1	64,00
MMP057	G 1" x 11	36	160	1	92,38
MMP058	G 1"1/8 x 11	30	170	1	201,71
MMP059	G 1"1/4 x 11	30	170	1	228,32
MMP060	G 1"1/2 x 11	32	190	1	338,36



HSS-CO	DIN 5156	Forma B 35°
--------	-------------	----------------

Rosca BSP (GAS) Navalhas Helicoidais HSS-CO

CÓDIGO	Medida	l mm	L mm	PCS	€
MMP070	G 1/8 x 28	20	90	1	20,47
MMP071	G 1/4 x 19	20	100	1	23,89
MMP072	G 3/8 x 19	22	100	1	29,02
MMP073	G 1/2 x 14	25	140	1	48,60
MMP074	G 5/8 x 14	25	140	1	49,04
MMP075	G 3/4 x 14	30	140	1	72,68
MMP076	G 7/8 x 14	30	160	1	83,68
MMP077	G 1" x 11	36	160	1	107,42
MMP078	G 1"1/8 x 11	30	170	1	227,12
MMP079	G 1"1/4 x 11	30	170	1	266,07
MMP080	G 1"1/2 x 11	32	190	1	462,62



MACHOS PARA MÁQUINA ROSCA MÉTRICA HSS-CO

HSS-CO BSW AND METRIC TIN MACHINE TAPS DIN371/376
TARAUDS POUR MACHINES À FILETAGE MÉTRIQUES HSS-CO

HSS-CO



HSS-CO



USO UNIVERSAL < 1000 N/mm²

DIN
371/376

Forma B

Navalhas Direitas DIN371/376 HSS-CO

CÓDIGO	Medida	l mm	L mm	PCS	€
DIN371					
MMP201	M 3 x 0,50	11	56	1	11,34
MMP202	M 4 x 0,70	13	63	1	11,34
MMP203	M 5 x 0,80	16	70	1	11,85
MMP204	M 6 x 1,00	19	80	1	11,85
MMP205	M 8 x 1,25	22	90	1	14,58
MMP206	M 10 x 1,50	24	100	1	16,54
DIN376					
MMP207	M 12 x 1,75	29	110	1	19,14
MMP208	M 14 x 2,00	30	110	1	27,38
MMP209	M 16 x 2,00	32	110	1	31,17
MMP210	M 18 x 2,50	34	125	1	42,83
MMP211	M 20 x 2,50	34	140	1	59,87
MMP212	M 22 x 2,50	34	140	1	66,59
MMP213	M 24 x 3,00	38	160	1	70,52
MMP214	M 27 x 3,00	38	160	1	84,14
MMP215	M 30 x 3,50	48	180	1	87,44



HSS-CO



USO UNIVERSAL < 1000 N/mm²

DIN
371/376

Forma B

Navalhas Helicoidais DIN371/376 HSS-CO

CÓDIGO	Medida	l mm	L mm	PCS	€
DIN371					
MMP250	M 3 x 0,50	11	56	1	13,63
MMP251	M 4 x 0,70	13	63	1	13,63
MMP252	M 5 x 0,80	16	70	1	14,20
MMP253	M 6 x 1,00	19	80	1	14,20
MMP254	M 8 x 1,25	22	90	1	17,37
MMP255	M 10 x 1,50	24	100	1	20,09
DIN376					
MMP256	M 12 x 1,75	29	110	1	20,85
MMP257	M 14 x 2,00	30	110	1	29,98
MMP258	M 16 x 2,00	32	110	1	31,68
MMP259	M 18 x 2,50	34	125	1	46,83
MMP260	M 20 x 2,50	34	140	1	65,97

USO UNIVERSAL < 1000 N/mm²



HSS-CO

DIN
371/376

Forma B



Jogo de Machos para Máquina Navalhas Direitas DIN371/376 HSS-CO

Composição 7 machos (1 de cada medida)

Ø M3 - M4 - M5 - M6 - M8 - M10 - M12

CÓDIGO €
MMP270 158,81

USO UNIVERSAL < 1000 N/mm²



HSS-CO

DIN
371/376

Forma B
35°



Jogo de Machos para Máquina Navalhas Helicoidais DIN371/376 HSS-CO

Composição 7 machos (1 de cada medida)

Ø M 3, M 4, M 5, M 6, M 8, M 10, M 12

CÓDIGO €
MMP271 170,50

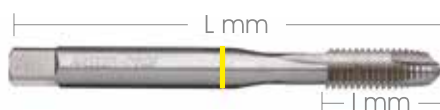

MACHOS P/MÁQUINA P/ TRABALHOS ESPECIAIS P/ INOX EM HSS-CO VAPO

HSS-CO MACHINE TAPS FOR SPECIAL INOX WORK

TARAUDS MACHINE HSS-CO POUR TRAVAUX SPÉCIAUX EN INOX

HSS-CO



HSS-CO
VAPO



AÇO INOX < 850 N/mm²

DIN
371/376

Forma B

Navalhas Direitas HSS-CO - VAPO

CÓDIGO	Medida	I mm	L mm	PCS	€
DIN371					
MMI01	M 3 x 0,50	11	56	1	13,48
MMI02	M 4 x 0,70	13	63	1	13,48
MMI03	M 5 x 0,80	16	70	1	14,50
MMI04	M 6 x 1,00	19	80	1	14,50
MMI05	M 8 x 1,25	22	90	1	16,71
MMI06	M 10 x 1,50	24	100	1	17,73
DIN376					
MMI07	M 12 x 1,75	29	110	1	19,67
MMI08	M 14 x 2,00	30	110	1	28,13
MMI09	M 16 x 2,00	32	110	1	31,98
MMI10	M 18 x 2,50	34	125	1	40,95
MMI11	M 20 x 2,50	34	140	1	61,53



HSS-CO
VAPO



AÇO INOX < 850 N/mm²

DIN
371/376

Forma B
35°

Navalhas Helicoidais HSS-CO - VAPO

CÓDIGO	Medida	I mm	L mm	PCS	€
DIN371					
MMI15	M 3 x 0,50	11	56	1	14,00
MMI16	M 4 x 0,70	13	63	1	14,00
MMI17	M 5 x 0,80	16	70	1	14,59
MMI18	M 6 x 1,00	19	80	1	14,59
MMI19	M 8 x 1,25	22	90	1	17,84
MMI20	M 10 x 1,50	24	100	1	20,64
DIN376					
MMI21	M 12 x 1,75	29	110	1	21,43
MMI22	M 14 x 2,00	30	110	1	30,80
MMI23	M 16 x 2,00	32	110	1	32,56
MMI24	M 18 x 2,50	34	125	1	48,13
MMI25	M 20 x 2,50	34	140	1	67,79

AÇO INOX < 850 N/mm²



HSS-CO
VAPO

DIN
371/376

Forma B



AÇO INOX < 850 N/mm²



HSS-CO
VAPO

DIN
371/376

Forma B
35°



Jogo de Machos para Máquina para Trabalhos Especiais Navalhas Direitas HSS-CO - VAPO

Composição 7 machos (1 de cada medida)

Ø M3 - M4 - M5 - M6 - M8 - M10 - M12

Jogo de Machos para Máquina para Trabalhos Especiais Navalhas Helicoidais HSS-CO - VAPO

Composição 7 machos (1 de cada medida)

Ø M3 - M4 - M5 - M6 - M8 - M10 - M12

CÓDIGO €
MMI90 109,53

CÓDIGO €
MMI91 155,57



MACHOS PARA MÁQUINA PARA TRABALHOS ESPECIAIS EM HSS-CO

HSS-CO MACHINE TAPS FOR SPECIAL WORK
TARAUDS MACHINE HSS-CO POUR TRAVAUX SPÉCIAUX

HSS-CO



HSS-CO



MATERIAIS DUROS < 1000 N/mm²

DIN
371/376

Forma B



HSS-CO



MATERIAIS DUROS < 1000 N/mm²

DIN
371/376

Forma B
35°

Rosca Métrica Navalhas Direitas HSS-CO

CÓDIGO	Medida	I mm	L mm	PCS	€
DIN371					
MMA30	M 3 x 0,50	11	56	1	12,29
MMA31	M 4 x 0,70	13	63	1	12,29
MMA32	M 5 x 0,80	16	70	1	12,84
MMA33	M 6 x 1,00	19	80	1	12,84
MMA34	M 8 x 1,25	22	90	1	15,79
MMA35	M 10 x 1,50	24	100	1	17,92
DIN376					
MMA36	M 12 x 1,75	29	110	1	20,72
MMA37	M 14 x 2,00	30	110	1	29,66
MMA38	M 16 x 2,00	32	110	1	33,70
MMA39	M 18 x 2,50	34	125	1	36,31
MMA40	M 20 x 2,50	34	140	1	64,87

Rosca Métrica Navalhas Helicoidais HSS-CO

CÓDIGO	Medida	I mm	L mm	PCS	€
DIN371					
MMA50	M 3 x 0,50	11	56	1	14,76
MMA51	M 4 x 0,70	13	63	1	14,76
MMA52	M 5 x 0,80	16	70	1	15,38
MMA53	M 6 x 1,00	19	80	1	15,38
MMA54	M 8 x 1,25	22	90	1	18,81
MMA55	M 10 x 1,50	24	100	1	21,76
DIN376					
MMA56	M 12 x 1,75	29	110	1	22,58
MMA57	M 14 x 2,00	30	110	1	32,47
MMA58	M 16 x 2,00	32	110	1	34,32
MMA59	M 18 x 2,50	34	125	1	50,72
MMA60	M 20 x 2,50	34	140	1	71,46

MATERIAIS DUROS < 1000 N/mm²



MATERIAIS DUROS < 1000 N/mm²



Jogo de Machos para Máquina
para Trabalhos Especiais Rosca Métrica
Navalhas Direitas HSS-CO

Composição 7 machos (1 de cada medida)

Ø M3 - M4 - M5 - M6 - M8 - M10 - M12

Jogo de Machos para Máquina
para Trabalhos Especiais Rosca Métrica
Navalhas Helicoidais HSS-CO

Composição 7 machos (1 de cada medida)

Ø M3 - M4 - M5 - M6 - M8 - M10 - M12

CÓDIGO €
MMA90 106,58

CÓDIGO €
MMA91 123,87

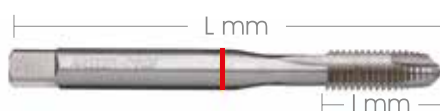

MACHOS PARA MÁQUINA PARA TRABALHOS ESPECIAIS EM HSS-CO

HSS-CO MACHINE TAPS FOR SPECIAL WORK

TARAUDS MACHINE HSS-CO POUR TRAVAUX SPÉCIAUX

HSS-CO



HSS-CO
TIALN

DIN
371/376

Forma B

Navalhas Direitas HSS-CO - TIALN

CÓDIGO	Medida	I mm	L mm	PCS	€
DIN371					
MMTI01	M 3 x 0,50	11	56	1	13,04
MMTI02	M 4 x 0,70	13	63	1	13,41
MMTI03	M 5 x 0,80	16	70	1	13,93
MMTI04	M 6 x 1,00	19	80	1	13,93
MMTI05	M 8 x 1,25	22	90	1	16,70
MMTI06	M 10 x 1,50	24	100	1	19,47
DIN376					
MMTI07	M 12 x 1,75	29	110	1	22,62
MMTI08	M 14 x 2,00	30	110	1	32,35
MMTI09	M 16 x 2,00	32	110	1	36,69
MMTI10	M 18 x 2,50	34	125	1	50,62
MMTI11	M 20 x 2,50	34	140	1	70,75

HSS-CO



DIN
371/376

Forma B
AZ

Rosca Alternada para Alumínio E INOX HSS-CO

CÓDIGO	Medida	I mm	L mm	PCS	€
DIN371					
MMA01	M 3 x 0,50	11	56	1	13,76
MMA02	M 4 x 0,70	13	63	1	14,71
MMA03	M 5 x 0,80	16	70	1	15,70
MMA04	M 6 x 1,00	19	80	1	16,67
MMA05	M 8 x 1,25	22	90	1	18,58
MMA06	M 10 x 1,50	24	100	1	21,04
DIN376					
MMA07	M 12 x 1,75	29	110	1	21,79
MMA08	M 14 x 2,00	30	110	1	31,37
MMA09	M 16 x 2,00	32	110	1	33,20
MMA10	M 18 x 2,50	34	125	1	49,02
MMA11	M 20 x 2,50	34	140	1	69,19



Nitrato
Titânio

DIN
371/376

Laminação HSS-CO Nitrato Titânio

CÓDIGO	Medida	I mm	L mm	PCS	€
DIN371					
MMLA01	M 3 x 0,50	11	56	1	13,55
MMLA02	M 4 x 0,70	13	63	1	13,55
MMLA03	M 5 x 0,80	16	70	1	14,20
MMLA04	M 6 x 1,00	19	80	1	14,20
MMLA05	M 8 x 1,25	22	90	1	17,37
MMLA06	M 10 x 1,50	24	100	1	20,02
DIN376					
MMLA07	M 12 x 1,75	29	110	1	20,79
MMLA08	M 14 x 2,00	30	110	1	57,89
MMLA09	M 16 x 2,00	32	110	1	67,10
MMLA10	M 18 x 2,50	34	125	1	67,39

OBSERVAÇÃO: O PRÉ-FURO NÃO É O MESMO DOS OUTROS MACHOS.

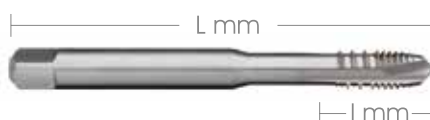

MACHOS P/ MÁQUINA MÉTRICA FINA EM HSS-CO DIN374/B (PASSES ESPECIAIS)

HSS-CO MACHINE TAPS WITH FINE METRIC DIN374/B (SPECIAL THREADS)

TARAUDS POUR MACHINE MÉTRIQUE FINE EN HSS-CO DIN374/B (PASSES SPÉCIALES)

HSS-CO



HSS-CO

DIN
374/B

ISO
2/6 H

CÓDIGO	Medida	I mm	L mm	PCS	€
MM001	MF 3 x 0,35	9	56	1	22,34
MM002	MF 4 x 0,35	10	63	1	22,34
MM003	MF 4 x 0,50	10	63	1	19,49
MM004	MF 5 x 0,50	12	70	1	19,49
MM005	MF 5 x 0,75	12	70	1	22,34
MM006	MF 6 x 0,50	14	80	1	20,04
MM007	MF 6 x 0,75	14	80	1	20,04
MM008	MF 7 x 0,75	14	80	1	27,57
MM009	MF 8 x 0,50	19	80	1	31,81
MM010	MF 8 x 0,75	19	80	1	25,85
MM011	MF 8 x 1,00	22	90	1	22,62
MM012	MF 9 x 0,75	19	80	1	30,18
MM013	MF 9 x 1,00	22	90	1	27,57
MM014	MF 10 x 0,75	20	90	1	26,34
MM015	MF 10 x 1,00	20	90	1	26,34
MM016	MF 10 x 1,25	24	100	1	26,34
MM017	MF 11 x 1,00	20	90	1	37,33
MM018	MF 11 x 1,25	22	90	1	37,33
MM019	MF 12 x 0,75	22	100	1	37,33
MM020	MF 12 x 1,00	22	100	1	30,76
MM021	MF 12 x 1,25	22	100	1	30,76
MM022	MF 12 x 1,50	22	100	1	30,76
MM023	MF 13 x 1,00	22	100	1	43,71
MM024	MF 13 x 1,50	22	100	1	43,71
MM025	MF 14 x 0,75	22	100	1	43,71
MM026	MF 14 x 1,00	22	100	1	43,71
MM027	MF 14 x 1,25	22	100	1	43,71
MM028	MF 14 x 1,50	22	100	1	40,99
MM029	MF 15 x 1,00	22	100	1	43,71
MM030	MF 15 x 1,50	22	100	1	43,71
MM031	MF 16 x 1,00	22	100	1	43,71
MM032	MF 16 x 1,25	22	100	1	43,71
MM033	MF 16 x 1,50	22	100	1	43,71
MM034	MF 18 x 1,00	25	110	1	52,62
MM035	MF 18 x 1,25	25	110	1	52,62
MM036	MF 18 x 1,50	25	110	1	52,62
MM037	MF 18 x 2,00	34	125	1	52,62
MM038	MF 20 x 1,00	25	125	1	56,12
MM039	MF 20 x 1,25	25	125	1	56,12
MM040	MF 20 x 1,50	25	125	1	56,12
MM041	MF 20 x 2,00	34	140	1	56,12
MM042	MF 21 x 1,50	25	125	1	75,99
MM043	MF 22 x 1,00	25	125	1	75,99
MM044	MF 22 x 1,25	25	125	1	75,99
MM045	MF 22 x 1,50	25	125	1	75,99
MM046	MF 22 x 2,00	34	140	1	75,99
MM047	MF 23 x 1,50	25	125	1	101,49
MM048	MF 24 x 1,00	28	140	1	87,72
MM049	MF 24 x 1,25	28	140	1	87,72
MM050	MF 24 x 1,50	28	140	1	87,72
MM051	MF 24 x 2,00	28	140	1	87,72

CÓDIGO	Medida	I mm	L mm	PCS	€
MM052	MF 25 x 1,00	28	140	1	101,49
MM053	MF 25 x 1,50	28	140	1	101,49
MM054	MF 26 x 1,00	28	140	1	100,63
MM055	MF 26 x 1,50	28	140	1	100,63
MM056	MF 26 x 2,00	28	140	1	100,63
MM057	MF 27 x 1,00	28	140	1	108,36
MM058	MF 27 x 1,50	28	140	1	108,36
MM059	MF 27 x 2,00	28	140	1	108,36
MM060	MF 28 x 1,00	28	140	1	108,36
MM061	MF 28 x 1,50	28	140	1	108,36
MM062	MF 28 x 2,00	28	140	1	108,36
MM063	MF 29 x 1,50	28	150	1	146,20
MM064	MF 30 x 1,00	28	150	1	125,56
MM065	MF 30 x 1,50	28	150	1	125,56
MM066	MF 30 x 2,00	28	150	1	125,56
MM067	MF 30 x 2,50	45	180	1	140,18
MM068	MF 30 x 3,00	45	180	1	140,18
MM069	MF 32 x 1,50	28	150	1	157,38
MM070	MF 32 x 2,00	28	150	1	157,38
MM071	MF 32 x 3,00	50	180	1	157,38
MM072	MF 33 x 1,50	30	160	1	175,46
MM073	MF 33 x 2,00	30	160	1	175,46
MM074	MF 33 x 3,00	50	180	1	175,46
MM075	MF 34 x 1,50	30	170	1	178,89
MM076	MF 34 x 2,00	30	170	1	178,89
MM077	MF 35 x 1,50	30	170	1	186,64
MM078	MF 36 x 1,50	30	170	1	186,64
MM079	MF 36 x 2,00	30	170	1	186,64
MM080	MF 36 x 3,00	56	200	1	186,64
MM081	MF 38 x 1,50	30	170	1	199,53
MM082	MF 39 x 1,50	30	170	1	199,53
MM083	MF 39 x 2,00	30	170	1	199,53
MM084	MF 39 x 3,00	60	200	1	199,53
MM085	MF 40 x 1,50	30	170	1	215,87
MM086	MF 40 x 2,00	30	170	1	215,87
MM087	MF 40 x 3,00	60	200	1	215,87
MM088	MF 42 x 1,50	30	170	1	257,15
MM089	MF 42 x 2,00	30	170	1	257,15
MM090	MF 42 x 3,00	60	200	1	257,15
MM091	MF 45 x 1,50	32	180	1	286,41
MM092	MF 45 x 2,00	32	180	1	286,41
MM093	MF 45 x 3,00	50	200	1	286,41
MM094	MF 48 x 1,50	32	190	1	341,45
MM095	MF 48 x 2,00	32	190	1	341,45
MM096	MF 48 x 3,00	50	225	1	341,45
MM097	MF 50 x 1,50	32	190	1	402,51
MM098	MF 50 x 2,00	32	190	1	402,51
MM099	MF 50 x 3,00	50	225	1	402,51
MM100	MF 52 x 1,50	32	190	1	438,63
MM101	MF 52 x 2,00	32	190	1	438,63
MM102	MF 52 x 3,00	50	225	1	438,63
MM103	MF 63 x 1,50	50	275	1	773,19

* Navalhas helicoidais sob consulta

APLICAÇÕES DE MACHOS PARA MÁQUINA

MACHINE TAPS APPLICATIONS
APPLICATIONS DES TARAUDS MACHINE



Machos para Máquina com Anel de Cor

Nome	Aço Construção ≤ 500 N/mm ²	Aço Construção ≥ 500 N/mm ²	Aço ≤ 1000 N/mm ²	Aço Temperado ≤ 1000 N/mm ²	Liga Aço ≤ 1200 N/mm ²
Forma B	●	●	●	○	
35°	●	●	●	○	
Broca Macho	●	○			
Forma B	●	●	●	●	●
35°	●	●	●	●	●
Forma B VAP					
35° / VAP					

Machos para Máquina Especiais

Forma B				●	●
Forma B				●	●
Forma B AZ	●	●			
Laminação					

● Recomendado

○ Adequado

APLICAÇÕES DE MACHOS PARA MÁQUINA

MACHINE TAPS APPLICATIONS
APPLICATIONS DES TARAUDS MACHINE

Machos para Máquina com Anel de Cor

Aços Duros 40 60 HRC ≤ 850 N/mm ²	Aço de Ferramenta ≤ 1000 N/mm ²	Fundição ≤ 300 HB	Cobre ≤ 400 N/mm	Liga Alumínio ≤ 450 N/mm	Óleo de Corte	Óleo Solúvel	Lubrificação Mínima	Trabalho a Seco
	○		○	○	●	●	●	
	○		○	○	●	●	●	
○		○		●	●			
	●				●	●	●	
	●				●	●	●	
●					●	●	●	
●					●	●	●	

Machos para Máquina Especiais

	●				●	●	●	
	●						●	●
		●	●		●			
			●	●	●	●		

● Recomendado ○ Adequado

MACHOS PARA TRABALHOS ESPECIAIS

MACHINE TAPS FOR SPECIAL WORKS

TARAUDS MACHINE POUR TRAVAUX SPÉCIAUX

HSS-CO



HSS-CO

DIN
13

Broca - Macho HSS-CO (2 em 1)

CÓDIGO	Medida	I mm	M mm	L mm	PCS	€
MMB01	M 3 x 0,50	16	11	56	1	24,52
MMB02	M 4 x 0,70	18	14	63	1	24,52
MMB03	M 5 x 0,80	20	18	71	1	24,52
MMB04	M 6 x 1,00	22	22	80	1	27,69
MMB05	M 8 x 1,25	26	25	95	1	30,86
MMB06	M 10 x 1,50	30	31	106	1	33,97
MMB07	M 12 x 1,75	32	35	115	1	45,55

HSS



HSS

DIN
3126

1/4

Broca - Macho - Escareador HSS (3 em 1)

CÓDIGO	Medida	I mm	L mm	PCS	€
MTX100	3 x 0,50	2,50	36	1	9,27
MTX101	4 x 0,70	3,30	39	1	9,27
MTX102	5 x 0,80	4,20	41	1	9,27
MTX103	6 x 1,00	5,00	44	1	9,27
MTX104	8 x 1,25	6,80	50	1	10,57
MTX105	10 x 1,50	8,50	59	1	10,57

HSS-CO



HSS

DIN
3126

1/4

Macho Bit HSS-CO

CÓDIGO	Medida	I mm	L mm	PCS	€
MMB20	3 x 0,50	2,50	33	1	6,70
MMB21	4 x 0,70	3,30	35	1	6,86
MMB22	5 x 0,80	4,20	36	1	7,51
MMB23	6 x 1,00	5,00	39	1	7,84
MMB24	8 x 1,25	6,80	40	1	10,13
MMB25	10 x 1,50	8,50	41	1	12,42

Jogo Macho - Bit

Composição 6 machos
(1 de cada medida)

Ø M3 - M4 - M5 - M6 -
M8 - M10 - M12

CÓDIGO	€
MMB29	55,56



HSS

Conta Fios Métrico ISO 60° - Wh 55°

CÓDIGO	Descrição	PCS	€
MMB99	52 pcs ISO 0,25 ÷ 6	1	14,87



CABEÇAS DE ROSCAR PARA MACHOS COM RETORNO AUTOMÁTICO

REVERSAL TAPPING CHUCKS

TÊTES DE FILETAGE AVEC RETOUR AUTOMATIQUE



(Acessórios incluídos)

CÓDIGO	Medida	Montagem	Capacidade	Ø D	Torque Máx.	Velocidade Máx. RPM	€
MACR01	7	B16	M2-M7	55	14	1500	530,40
MACR02	12	B16	M5-M12	75	65	1000	620,54
MACR03	20	B22	M8-M20	91	125	600	722,64



Pinças para cabeça de roscar

CÓDIGO	Medida	Capacidade	Aperto	€
MACR05	7	M2 - M7	Ø 2,5-4,2	48,66
MACR06	7	M4 - M7	Ø 4,2-6,5	48,66
MACR07	12	M5 - M8	Ø 3,5-7	48,66
MACR08	12	M8 - M12	Ø 7,0-10,0	48,66
MACR09	20	M8 - M14	Ø 6,0-9,0	48,66
MACR10	20	M14 - M20	Ø 9,0-14,0	48,66

CAÇONETES EM HSS

DIES
FILIÈRES

HSS



HSS

DIN
EN 22568
(DIN 223)

Rosca Métrica HSS

CÓDIGO	Medida	Ø	PCS	€
MCP20	M 2 x 0,40	16	1	11,23
MCP21	M 2,5 x 0,45	16	1	11,23
MCP22	M 3 x 0,50	20	1	8,76
MCP23	M 3,5 x 0,60	20	1	8,76
MCP24	M 4 x 0,70	20	1	8,43
MCP25	M 5 x 0,80	20	1	8,43
MCP27	M 6 x 1,00	20	1	8,43
MCP28	M 7 x 1,00	25	1	10,12
MCP30	M 8 x 1,25	25	1	10,02
MCP31	M 9 x 1,25	25	1	10,02
MCP34	M 10 x 1,50	30	1	10,02
MCP35	M 11 x 1,50	30	1	14,26
MCP38	M 12 x 1,75	38	1	15,15
MCP42	M 14 x 2,00	38	1	16,15
MCP45	M 16 x 2,00	45	1	21,40
MCP48	M 18 x 2,50	45	1	23,15
MCP51	M 20 x 2,50	45	1	24,10
MCP53	M 22 x 2,50	55	1	33,65
MCP56	M 24 x 3,00	55	1	37,70
MCP59	M 27 x 3,00	65	1	61,57
MCP62	M 30 x 3,50	65	1	61,57



HSS

DIN
EN 22568
(DIN 223)

Rosca Métrica Fina HSS

CÓDIGO	Medida	Ø	PCS	€
MCP26	MF 6 x 0,75	20	1	12,42
MCP29	MF 8 x 1,00	25	1	12,78
MCP32	MF 10 x 1,00	30	1	14,80
MCP33	MF 10 x 1,25	30	1	14,80
MCP63	MF 12 x 1,00	38	1	20,34
MCP36	MF 12 x 1,25	38	1	20,34
MCP37	MF 12 x 1,50	38	1	20,34
MCP39	MF 14 x 1,00	38	1	20,34
MCP40	MF 14 x 1,25	38	1	20,34
MCP41	MF 14 x 1,50	38	1	20,34
MCP43	MF 16 x 1,00	45	1	27,68
MCP44	MF 16 x 1,50	45	1	27,68
MCP46	MF 18 x 1,00	45	1	30,07
MCP47	MF 18 x 1,50	45	1	30,07
MCP49	MF 20 x 1,50	45	1	31,39
MCP50	MF 20 x 2,00	45	1	31,39
MCP52	MF 22 x 1,50	55	1	43,54
MCP54	MF 24 x 1,50	55	1	49,04
MCP55	MF 24 x 2,00	55	1	49,04
MCP57	MF 25 x 1,50	55	1	49,04
MCP58	MF 27 x 2,00	65	1	61,57
MCP60	MF 30 x 1,50	65	1	83,86
MCP61	MF 30 x 2,00	65	1	83,86



HSS

ISO

Especiais para Estojos Rosca Métrica HSS

CÓDIGO	Medida	Ø	PCS	€
MCPE30	M 2 x 0,40	25 x 9	1	20,90
MCPE31	M 3 x 0,50	25 x 9	1	12,53
MCPE32	M 4 x 0,70	25 x 9	1	12,53
MCPE33	M 5 x 0,80	25 x 9	1	12,53
MCPE34	M 6 x 1,00	25 x 9	1	12,53
MCPE35	M 7 x 1,00	25 x 9	1	12,53
MCPE36	M 8 x 1,25	25 x 9	1	12,53
MCPE37	M 10 x 1,50	25 x 9	1	12,53
MCPE39	M 10 x 1,50	38 x 14	1	20,19
MCPE38	M 12 x 1,75	25 x 9	1	14,23
MCPE40	M 12 x 1,75	38 x 14	1	20,19
MCPE41	M 14 x 2,00	38 x 14	1	20,19
MCPE42	M 16 x 2,00	38 x 14	1	20,19
MCPE43	M 18 x 2,50	38 x 14	1	28,22
MCPE44	M 20 x 2,50	38 x 14	1	28,22



HSS

ISO

Especiais para Estojos Métrica Fina HSS

CÓDIGO	Medida	Ø	PCS	€
MCPE50	M 8 x 1,00	25 x 9	1	15,97
MCPE51	M 10 x 1,00	38 x 14	1	20,19
MCPE52	M 10 x 1,25	38 x 14	1	20,19
MCPE53	M 12 x 1,25	38 x 14	1	20,19
MCPE54	M 12 x 1,50	38 x 14	1	20,19
MCPE55	M 14 x 1,25	38 x 14	1	20,19
MCPE56	M 14 x 1,50	38 x 14	1	20,19
MCPE57	M 16 x 1,50	38 x 14	1	20,19
MCPE58	M 18 x 1,50	38 x 14	1	20,19

CAÇONETES ROSCA MÉTRICA FINA HSS (PASSES ESPECIAIS)

HSS METRIC FINE THREAD DIES (SPECIAL THREADS)

FILIÈRES DE FILETAGE MÉTRIQUE FIN HSS (PASSES SPÉCIALES)

HSS



Rosca Métrica Fina HSS

CÓDIGO	Medida	Ø	PCS	€
MCF01	MF 3 x 0,35	20	1	11,86
MCF02	MF 4 x 0,35	20	1	18,63
MCF03	MF 4 x 0,50	20	1	11,86
MCF04	MF 5 x 0,50	20	1	11,86
MCF05	MF 5 x 0,75	20	1	16,19
MCF06	MF 6 x 0,50	20	1	16,19
MCF07	MF 7 x 0,75	25	1	16,19
MCF08	MF 8 x 0,50	25	1	16,19
MCF09	MF 8 x 0,75	25	1	12,90
MCF10	MF 9 x 0,75	25	1	28,43
MCF11	MF 9 x 1,00	25	1	17,56
MCF12	MF 10 x 0,75	30	1	15,45
MCF13	MF 11 x 1,00	30	1	21,25
MCF14	MF 11 x 1,25	30	1	21,25
MCF15	MF 12 x 0,75	38	1	27,93
MCF16	MF 13 x 1,00	38	1	29,41
MCF17	MF 13 x 1,50	38	1	29,41
MCF18	MF 14 x 0,75	38	1	36,09
MCF19	MF 15 x 1,00	38	1	46,95
MCF20	MF 15 x 1,50	38	1	34,01
MCF21	MF 16 x 1,25	45	1	38,50
MCF22	MF 18 x 1,25	45	1	46,95
MCF23	MF 18 x 2,00	45	1	31,17
MCF24	MF 20 x 1,00	45	1	33,07
MCF25	MF 20 x 1,25	45	1	33,07
MCF26	MF 21 x 1,50	45	1	56,01
MCF27	MF 22 x 1,00	55	1	51,85
MCF28	MF 22 x 1,25	55	1	51,85
MCF29	MF 22 x 2,00	55	1	48,45
MCF30	MF 23 x 1,50	55	1	100,81
MCF31	MF 24 x 1,00	55	1	52,77
MCF32	MF 24 x 1,25	55	1	52,77
MCF33	MF 25 x 1,00	55	1	73,23
MCF34	MF 26 x 1,00	55	1	91,50
MCF35	MF 26 x 1,50	55	1	91,50
MCF36	MF 26 x 2,00	55	1	91,50
MCF37	MF 27 x 1,00	65	1	105,44
MCF38	MF 27 x 1,50	65	1	105,44
MCF39	MF 28 x 1,00	65	1	105,44
MCF40	MF 28 x 1,50	65	1	105,44
MCF41	MF 28 x 2,00	65	1	105,44

Rosca Métrica Fina HSS

CÓDIGO	Medida	Ø	PCS	€
MCF42	MF 29 x 1,50	65	1	105,44
MCF43	MF 30 x 1,00	65	1	105,44
MCF44	MF 30 x 2,50	65	1	105,44
MCF45	MF 30 x 3,00	65	1	105,44
MCF46	MF 32 x 1,50	65	1	104,42
MCF47	MF 32 x 2,00	65	1	104,42
MCF48	MF 32 x 3,00	65	1	104,42
MCF49	MF 33 x 1,50	65	1	119,15
MCF50	MF 33 x 2,00	65	1	119,15
MCF51	MF 33 x 3,00	65	1	119,15
MCF52	MF 34 x 1,50	65	1	119,15
MCF53	MF 34 x 2,00	65	1	119,15
MCF54	MF 35 x 1,50	65	1	125,01
MCF55	MF 36 x 1,50	65	1	125,01
MCF56	MF 36 x 2,00	65	1	125,01
MCF57	MF 36 x 3,00	65	1	125,01
MCF58	MF 38 x 1,50	75	1	213,38
MCF59	MF 39 x 1,50	75	1	185,55
MCF60	MF 39 x 2,00	75	1	185,55
MCF61	MF 39 x 3,00	75	1	213,38
MCF62	MF 40 x 1,50	75	1	247,66
MCF63	MF 40 x 2,00	75	1	185,55
MCF64	MF 40 x 3,00	75	1	185,55
MCF65	MF 42 x 1,50	75	1	185,55
MCF66	MF 42 x 2,00	75	1	185,55
MCF67	MF 42 x 3,00	75	1	237,94
MCF68	MF 45 x 1,50	90	1	297,73
MCF69	MF 45 x 2,00	90	1	297,73
MCF70	MF 45 x 3,00	90	1	297,73
MCF71	MF 48 x 1,50	90	1	297,73
MCF72	MF 48 x 2,00	90	1	297,73
MCF73	MF 48 x 3,00	90	1	397,80
MCF74	MF 50 x 1,50	90	1	298,11
MCF75	MF 50 x 2,00	90	1	297,73
MCF76	MF 50 x 3,00	90	1	297,73
MCF77	MF 52 x 1,50	90	1	297,73
MCF78	MF 52 x 2,00	90	1	297,73
MCF79	MF 52 x 3,00	90	1	297,73
MCF80	MF 63 x 1,50	105	1	576,15

CAÇONETES

DIES
FILIERES

HSS	DIN 223	BSW
-----	------------	-----



Rosca BSW/Whitworth HSS

CÓDIGO	Medida	Ø	PCS	€
MCP65	W 1/8 x 40	20	1	12,32
MCP66	W 5/32 x 32	20	1	12,32
MCP67	W 3/16 x 24	20	1	12,32
MCP68	W 7/32 x 24	20	1	14,04
MCP69	W 1/4 x 20	20	1	14,04
MCP70	W 5/16 x 18	25	1	14,04
MCP71	W 3/8 x 16	30	1	15,84
MCP72	W 7/16 x 14	30	1	20,85
MCP73	W 1/2 x 12	38	1	23,97
MCP74	W 9/16 x 12	38	1	23,97
MCP75	W 5/8 x 11	45	1	28,94
MCP76	W 3/4 x 10	45	1	35,29
MCP77	W 7/8 x 9	55	1	52,79
MCP78	W 1" x 8	55	1	54,93
MCP79	W 1"1/4 x 7	76	1	174,23
MCP80	W 1"1/2 x 6	76	1	174,23

HSS	DIN 223	UNF SAE
-----	------------	------------



Rosca UNF/SAE HSS

CÓDIGO	Medida	Ø	PCS	€
MCP82	UNF 1/4 x 28	20	1	17,11
MCP83	UNF 5/16 x 24	25	1	17,11
MCP84	UNF 3/8 x 24	30	1	19,51
MCP85	UNF 7/16 x 20	30	1	19,57
MCP86	UNF 1/2 x 20	38	1	26,48
MCP87	UNF 9/16 x 18	38	1	26,48
MCP88	UNF 5/8 x 18	45	1	33,22
MCP89	UNF 3/4 x 16	45	1	39,41
MCP90	UNF 7/8 x 14	55	1	54,36
MCP91	UNF 1" x 12	55	1	58,67

HSS	DIN 223	UNC
-----	------------	-----



Rosca UNC HSS

CÓDIGO	Medida	Ø	PCS	€
MCU01	UNC 1/4 x 20	20	1	18,04
MCU02	UNC 5/16 x 18	25	1	12,74
MCU03	UNC 3/8 x 16	30	1	15,15
MCU04	UNC 7/16 x 14	30	1	15,20
MCU05	UNC 1/2 x 13	38	1	23,97
MCU06	UNC 9/16 x 12	38	1	23,97
MCU07	UNC 5/8 x 11	45	1	31,20
MCU08	UNC 3/4 x 10	45	1	32,37
MCU09	UNC 7/8 x 9	55	1	47,01

Até ao fim de existência

HSS	DIN 5158	BSP GAS
-----	-------------	------------



Rosca BSP - GAS

CÓDIGO	Medida	Ø	PCS	€
MCG20	G 1/8 x 28	30	1	13,81
MCG21	G 1/4 x 19	38	1	18,88
MCG22	G 3/8 x 19	45	1	24,46
MCG23	G 1/2 x 14	45	1	24,46
MCG24	G 5/8 x 14	55	1	39,41
MCG25	G 3/4 x 14	55	1	40,99
MCG26	G 7/8 x 14	65	1	53,35
MCG27	G 1" x 11	65	1	54,30
MCG29	G 1"1/4 x 11	75	1	70,14
MCG31	G 1"1/2 x 11	90	1	113,42
MCG33	G 2" x 11	105	1	139,07

HSS-CO	DIN 223	INOX
--------	------------	------

HSS-CO



Rosca Métrica HSS-CO para INOX-VAPO

CÓDIGO	Medida	Ø	PCS	€
MCPI02	M 3 x 0,50	20,6	1	12,92
MCPI03	M 4 x 0,70	20,6	1	12,50
MCPI04	M 5 x 0,80	20,6	1	11,48
MCPI14	M 6 x 1,00	20,6	1	11,48
MCPI07	M 8 x 1,25	25,4	1	15,40
MCPI08	M 10 x 1,50	30	1	18,96
MCPI09	M 12 x 1,75	38,1	1	22,57
MCPI10	M 14 x 2,00	38,1	1	24,57
MCPI11	M 16 x 2,00	45	1	34,95
MCPI12	M 18 x 2,50	45	1	35,11
MCPI13	M 20 x 2,50	45	1	37,11

DESANDADORES E EXTRATORES

TAPS AND DIES HOLDERS / SCREW EXTRACTORS

PORTE-TARAUDS ET PORTE-FILIÈRES / EXTRACTEUR VIS

ZAMAC



Desandador de Machos em ZAMAC

CÓDIGO	Medida	Métrica	BSW	BSP	€
MMZD01	Nº 0	1 ÷ 8	1/16 ÷ 1/4		2,82
MMZD07	Nº 1	1 ÷ 10	1/16 ÷ 3/8	1/8	3,47
MMZD03	Nº 2	4 ÷ 12	5/32 ÷ 1/2	1/8	7,94
MMZD04	Nº 3	5 ÷ 20	7/32 ÷ 3/4	1/8 ÷ 1/2	16,08
MMZD05	Nº 4	11 ÷ 27	7/16 ÷ 1"	1/4 ÷ 3/4	20,43
MMZD06	Nº 5	13 ÷ 32	1/2 ÷ 1"1/4	1/4 ÷ 1"	30,92

ZAMAC



Desandador de Caçonetes em ZAMAC

CÓDIGO	Medida	Métrica	BSW/ BSP	€
MCZD01	16 x 5	M 1 ÷ 2,6	W 1/16 ÷ 3/32	2,41
MCZD03	20 x 7	M 4,5 ÷ 6	W 3/16 ÷ 1/4	2,75
MCZD04	25 x 9	M 7 ÷ 9	W 5/16	3,43
MCZD05	30 x 11	M 10 ÷ 11	W 3/8 ÷ 7/16	4,84
MCZD07	38 x 14	M 12 ÷ 14	W 1/2 ÷ 9/16	7,16
MCZD09	45 x 18	M 16 ÷ 20	W 5/8 ÷ 13/16	10,26
MCZD11	55 x 22	M 22 24	W 7/8 ÷ 1"	14,84
MCZD13	65 x 25	M 27 36	W 1"1/8 ÷ 1"3/8	21,42

AÇO



Desandador de Machos em Aço

CÓDIGO	Medida	Métrica	BSW	BSP	€
MMCD01	Nº 0	1 ÷ 8	1/16 ÷ 1/4		12,96
MMCD02	Nº 1	1 ÷ 10	1/16 ÷ 3/8	1/8	13,88
MMCD03	Nº 2	4 ÷ 12	5/32 ÷ 1/2	1/8	20,36
MMCD04	Nº 3	5 ÷ 20	7/32 ÷ 3/4	1/8 ÷ 1/2	33,32
MMCD05	Nº 4	11 ÷ 27	7/16 ÷ 1"	1/4 ÷ 3/4	53,58
MMCD06	Nº 5	13 ÷ 32	1/2 ÷ 1"1/4	1/4 ÷ 1"	94,66
MMCD07	Nº 6	18 ÷ 42	3/4 ÷ 1"1/2	1/2 1"1/4	105,90
MMCD08	Nº 7	25 ÷ 52	1 ÷ 2"1/8	3/4 2" 1/4	122,93

AÇO



Desandador de Caçonetes em Aço

CÓDIGO	Medida	Métrica	BSW/ BSP	€
MCD20	20 x 7	M 4,5 ÷ 6	W 3/16 ÷ 1/4	16,19
MCD25	25 x 9	M 7 ÷ 9	W 5/16	18,28
MCD30	30 x 11	M 10 ÷ 11	W 3/8 ÷ 7/16	18,28
MCD38	38 x 14	M 12 ÷ 14	W 1/2 ÷ 9/16	20,90
MCD45	45 x 18	M 16 ÷ 20	W 5/8 ÷ 13/16	27,43
MCD55	55 x 22	M 22 ÷ 24	W 7/8 ÷ 1"	33,98
MCD65	65 x 25	M 27 36	W 1"1/8 ÷ 1"3/8	46,75
MCD75	75 x 30	M 39 42	W 1"1/2 ÷ 1"5/8	102,35



Desandador de Machos com Roquete ISO

CÓDIGO	Medida	Capacidade	PCS	€
MMD01	M 3 - M 10	85 mm	1	13,27
MMD02	M 5 - M 12	100 mm	1	16,83



Desandador de Machos com Roquete Longo

CÓDIGO	Medida	Capacidade	PCS	€
MML01	M 3 - M 10	250 mm	1	22,55
MML02	M 5 - M 12	300 mm	1	30,37



Extrator de Parafusos

CÓDIGO	(mm)	Medida (")	PCS	€
MMEX1	3 - 6	1/8 - 1/4	1	1,45
MMEX2	6 - 8	1/4 - 5/16	1	1,45
MMEX3	8 - 11	5/16 - 7/16	1	1,77
MMEX4	11 - 14	7/16 - 9/16	1	2,08
MMEX5	14 - 18	9/16 - 3/4	1	2,71
MMEX6	18 - 24	3/4 - 1"	1	3,77



Jogo de Extratores de Parafusos (Caixa Plástica)

CÓDIGO	Medida (")	PCS	€
MMEX7	3 a 18	1	10,01
MMEX8	3 a 24	1	14,48

ESTOJOS DE MACHOS E CAÇONETES HSS-G E HSS-CO

HSS-G AND HSS-CO DRILLS AND DIES CASES IN METAL BOX
ASSORTIMENTS POUR TARAUDS ET FILIÈRES HSS-G ET HSS-CO

HSS



Estojo de 3 a 12 HSS-G

Composição 30 peças

Machos (3 de cada medida)
M3, M4, M5, M6, M8, M10, M12

Caçonetes (1 de cada medida)
M3, M4, M5, M6, M8, M10, M12

1 Desandador de machos N°1

1 Desandador de caçonetes 25,4

CÓDIGO

€

MJOGO01

73,30

HSS



Estojo de 3 a 20 HSS-G

Composição 54 peças

Machos (3 de cada medida)
M3, M4, M5, M6, M8, M10, M12, M14, M16, M18, M20

Caçonetes (1 de cada medida)
M3, M4, M5, M6, M8, M10, M12, M14, M16, M18, M20

Desandador de caçonetes (1 de cada medida)
20×5, 20×7, 25, 30, 38, 45

Desandador de machos (1 de cada medida) N°1, N°3

Roquetes (1 de cada medida) N°1, N°2

CÓDIGO

€

MJOGO02

320,00

HSS

HSS-CO



Estojo de 3 a 24 HSS-G

Composição 61 peças

Machos (3 de cada medida) M3, M4, M5, M6, M8, M10, M12, M14, M16, M18, M20, M22, M24

Caçonetes (1 de cada medida) M3, M4, M5, M6, M8, M10, M12, M14, M16, M18, M20, M22, M24

Desandador de caçonetes (1 de cada medida) 20×5, 20×7, 25, 30, 38, 45, 55

Desandador de machos (1 de cada medida) N°1, N°4

CÓDIGO

€

MJOGO03

629,33

Estojo de 3 a 24 HSS-CO

Composição 61 peças

Machos (3 de cada medida) M3, M4, M5, M6, M8, M10, M12, M14, M16, M18, M20, M22, M24

Caçonetes (1 de cada medida) M3, M4, M5, M6, M8, M10, M12, M14, M16, M18, M20, M22, M24

Desandador de caçonetes (1 de cada medida)
20×5, 20×7, 25, 30, 38, 45, 55

Desandador de machos (1 de cada medida) N°1, N°4

CÓDIGO

€

MJOGO04

1088,00

ESTOJOS DE MACHOS E CAÇONETES HSS-G

THREADING SETS IN METAL OR WOOD CASES
ASSORTIMENTS POUR TARAUDS ET FILIÈRES HSS-G

HSS



HSS



Estojo BSW 1/8 a 1/2" (Caixa Metálica)

Composição 36 peças

Machos (3 de cada medida) 1/8, 3/16, 1/4, 5/16, 3/8, 7/16, 1/2
Caçonetes (1 de cada medida) 1/8, 3/16, 1/4, 5/16, 3/8, 7/16, 1/2
Desandador de machos (1 de cada medida) N°1, N°2 Roquetes N°1
Desandador de caçonetes (1 de cada medida) 20×5, 20×7, 25, 30, 38

CÓDIGO	€
MJOGO05	566,20

Estojo BSW 1/4 a 3/4" (Caixa Plástica)

Composição 39 peças

Machos (3 de cada medida) 1/4, 5/16, 3/8, 7/16, 1/2, 9/16, 5/8, 3/4
Caçonetes (1 de cada medida) 1/4, 5/16, 3/8, 7/16, 1/2, 9/16, 5/8, 3/4
Desandador de machos (1 de cada medida) N°1, N°3
Desandador de caçonetes (1 de cada medida) 20×7, 25, 30, 38, 45

CÓDIGO	€
MJOGO06	571,43

Estojo BSW 1/4 a 1" (Caixa Plástica)

Composição 43 peças

Machos (3 de cada medida) 1/4, 5/16, 3/8, 7/16, 1/2, 5/8, 3/4, 7/8, 1"
Caçonetes (1 de cada medida) 1/4, 5/16, 3/8, 7/16, 1/2, 5/8, 3/4, 7/8, 1"
Desandador de machos (1 de cada medida) N°1, N°4
Desandador de caçonetes (1 de cada medida) 20×7, 25, 30, 38, 45

CÓDIGO	€
MJOGO07	785,71

ESTOJO DE MACHOS E CAÇONETES AUTO ESPECIAIS P/ GARAGEM EM C. V.

THREADING SET FOR AUTOMOTIVE IN C. V.
ASSORTIMENTS POUR TARAUDS ET FILIÈRES SPÉCIALES POUR LE GARAGE

CROMO VANADIUM



Estojo M2 a M18 (Caixa Metálica) Rosca Métrica e Rosca Métrica Fina

Composição 110 peças

Machos (2 de cada medida)		Caçonetes (1 de cada medida)	
M2×0,40	M11×0,75	M2×0,40	M11×0,75
M3×0,50	M11×1,00	M3×0,50	M11×1,00
M4×0,70	M11×1,25	M4×0,70	M11×1,25
M5×0,80	M11×1,50	M5×0,80	M11×1,50
M6×0,75	M12×0,75	M6×0,75	M12×0,75
M6×1,00	M12×1,00	M6×1,00	M12×1,00
M7×0,75	M12×1,25	M7×0,75	M12×1,25
M7×1,00	M12×1,50	M7×1,00	M12×1,50
M8×0,75	M12×1,75	M8×0,75	M12×1,75
M8×1,00	M14×1,00	M8×1,00	M14×1,00
M8×1,25	M14×1,25	M8×1,25	M14×1,25
M9×0,75	M14×1,50	M9×0,75	M14×1,50
M9×1,00	M14×2,00	M9×1,00	M14×2,00
M9×1,25	M16×1,00	M9×1,25	M16×1,00
M10×0,75	M16×1,50	M10×0,75	M16×1,50
M10×1,00	M16×2,00	M10×1,00	M16×2,00
M10×1,25	M18×1,50	M10×1,25	M18×1,50
M10×1,50		M10×1,50	

Desandador de machos N°1 e N°3
Desandador de caçonetes 25,4 e 38,1
Roquete N°1

CÓDIGO	€
MMEM123	294,00

JOGOS DE MACHOS DE MÁQUINA, ESCAREADORES E CAÇONETES EM HSS

PROFESSIONAL KIT FOR DRILLING, DEBURRING AND THREADING
KIT PROFESSIONNEL POUR LE PERÇAGE, L'ALÉSAGE ET LE TARAUDAGE

HSS



Jogo de Machos de Máquina-Brocas HSS M3-M12	
Composição 15 peças	
Jogo de machos maquina - brocas Machos DIN 352 M3 / M4 / M5 / M6 / M8 / M10 / M12 Brocas ø 2,5 / 3,3 / 4,2 / 5,0 / 6,8 / 8,5 / 10,2 mm +desandador de machos	

CÓDIGO	€
MM901	47,77



Jogo de Escareadores HSS	
Composição 6 peças	
Escareador DIN335C ø 6,3/8,3/10,4/12,4/16,5/20,5	

CÓDIGO	€
MM902	49,76



Jogo de Caçonetes HSS	
Composição 8 peças	
Caçonetes DIN223 ø 25 mm: M3 / M4 / M5 / M6 / M8 / M10 / M12 +desandador de caçonetes 25 x 9	

CÓDIGO	€
MM903	33,77





JOGOS PARA REPARAR ROSCAS K-COIL

K-COIL THREAD REPAIR SETS

JEUX DE RÉPARATION DE FILETS K-COIL

HSS



CÓDIGO						€
KC600	M 2 x 0,40	2,1mm	Nº2	Nº2	20PCS	20,57
KC601	M 2,5 x 0,45	2,6mm	Nº3	Nº3	20PCS	20,57
KC602	M 3 x 0,50	3,2mm	Nº4	Nº4	20PCS	20,57
KC603	M 3,5 x 0,60	3,7mm	Nº5	Nº5	20PCS	20,57
KC604	M 4 x 0,70	4,2mm	Nº6	Nº6	20PCS	20,57
KC605	M 5 x 0,80	5,2mm	Nº8	Nº8	20PCS	21,38
KC606	M 6 x 1,00	6,3mm	Nº9	Nº9	20PCS	23,07
KC607	M 7 x 1,00	7,3mm	Nº10	Nº10	20PCS	29,36
KC608	M 8 x 1,25	8,3mm	Nº11	Nº11	20PCS	29,36
KC609	M 8 x 1,00	8,3mm	Nº11	Nº11	20PCS	29,36
KC610	M 9 x 1,25	9,3mm	Nº12	Nº12	15PCS	32,57
KC611	M 10 x 1,50	10,4mm	Nº13	Nº13	15PCS	31,37
KC612	M 10 x 1,25	10,3mm	Nº13	Nº13	15PCS	31,37
KC613	M 10 x 1,00	10,3mm	Nº13	Nº13	15PCS	31,37
KC614	M 11 x 1,50	11,4mm	Nº14	Nº14	10PCS	35,16
KC615	M 12 x 1,75	12,4mm	Nº15	Nº15	10PCS	35,16
KC616	M 12 x 1,50	12,4mm	Nº15	Nº15	10PCS	35,16
KC617	M 12 x 1,25	12,3mm	Nº15	Nº15	10PCS	35,16
KC618	M 12 x 1,00	12,3mm	Nº15	Nº15	10PCS	35,16
KC619	M 14 x 2,00		Nº16		10PCS	42,17
KC620	M 14 x 1,50		Nº16		10PCS	42,17
KC621	M 14 x 1,25		Nº17		10PCS	42,17
KC622	M 14 x 1,00		Nº17		10PCS	42,17
KC623	M 16 x 2,00		Nº18		10PCS	51,05
KC624	M 16 x 1,50		Nº18		10PCS	51,05
KC625	M 18 x 2,50		Nº20		5PCS	64,62
KC626	M 18 x 2,00		Nº20		5PCS	64,62
KC627	M 18 x 1,50		Nº20		5PCS	64,62
KC628	M 20 x 2,50		Nº21		5PCS	69,98
KC629	M 20 x 2,00		Nº21		5PCS	69,98
KC630	M 20 x 1,50		Nº21		5PCS	69,98
KC631	M 22 x 2,50		Nº22		5PCS	80,60
KC632	M 22 x 2,00		Nº22		5PCS	80,60
KC633	M 22 x 1,50		Nº22		5PCS	80,60
KC634	M 24 x 3,00		Nº23		5PCS	92,93
KC635	M 24 x 2,00		Nº23		5PCS	92,93
KC636	M 24 x 1,50		Nº23		5PCS	92,93

Outras medidas sob consulta

JOGOS PARA REPARAR ROSCAS K-COIL UNF E BSP

K-COIL UNF AND BSP THREAD REPAIR SETS

TROUSSE POUR RÉTABLIR TARAUDAGES ENDOMMAGÉES

HSS



Jogos para Reparar Roscas K-Coil UNF

CÓDIGO									€
KC669	UNF	1/4	x	28	6,7mm	Nº9	Nº9	20PCS	48,15
KC670	UNF	5/16	x	24	8,3mm	Nº11	Nº11	20PCS	69,14
KC671	UNF	3/8	x	24	9,8mm	Nº13	Nº13	15PCS	62,96
KC672	UNF	7/16	x	20	11,5mm	Nº14	Nº14	10PCS	70,65
KC673	UNF	1/2	x	20	13mm	Nº15	Nº15	10PCS	77,55
KC674	UNF	9/16	x	18		Nº16		10PCS	104,16
KC675	UNF	5/8	x	18		Nº18		10PCS	104,16
KC676	UNF	3/4	x	16		Nº21		5PCS	132,34
KC677	UNF	7/8	x	14		Nº22		5PCS	161,32
KC678	UNF	1"	x	12		Nº23		4PCS	153,49

Outras medidas sob consulta

Jogos para Reparar Roscas K-Coil BSP

CÓDIGO									€
KC705	BSP	1/8	x	28		1		10PCS	97,89
KC706	BSP	1/4	x	19		1		10PCS	106,50
KC707	BSP	3/8	x	19		1		10PCS	114,33
KC708	BSP	1/2	x	14		1		10PCS	138,61
KC709	BSP	5/8	x	14		1		10PCS	325,76
KC710	BSP	3/4	x	14		1		10PCS	325,76
KC711	BSP	7/8	x	14		1		10PCS	447,93
KC712	BSP	1"	x	11		1		10PCS	447,93

Outras medidas sob consulta





JOGOS PARA REPARAR ROSCAS K-COIL

K-COIL THREAD REPAIR SETS

TROUSSE POUR RÉTABLIR TARAUDAGES ENDOMMAGÉES

HSS



CÓDIGO		PCS						€
KC751	M5 a M12	130	M 5 x 0,80	5,2mm	Nº8	Nº8	25PCS	108,92
			M 6 x 1,00	6,3mm	Nº9	Nº9	25PCS	
			M 8 x 1,25	8,3mm	Nº11	Nº11	25PCS	
			M 10 x 1,50	10,4mm	Nº13	Nº13	25PCS	
			M 12 x 1,75	12,4mm	Nº15	Nº15	10PCS	
KC750	M6 a M10	87	M 6 x 1,00	6,3mm	Nº9	Nº9	25PCS	144,75
			M 8 x 1,25	8,3mm	Nº11	Nº11	25PCS	
			M 10 x 1,50	10,4mm	Nº13	Nº13	25PCS	
KC752	M6 a M14x1,25	113	M 6 x 1,00	6,3mm	Nº9	Nº9	25PCS	264,61
			M 8 x 1,25	8,3mm	Nº11	Nº11	25PCS	
			M 10 x 1,50	10,4mm	Nº13	Nº13	25PCS	
			M 12 x 1,75	12,4mm	Nº15	Nº15	10PCS	
			M 14 x 1,25		Nº17		10PCS	
KC753	M6 a M14x1,25	115	M 6 x 1,00	6,3mm	Nº9	Nº9	25PCS	262,90
			M 8 x 1,25	8,3mm	Nº11	Nº11	25PCS	
			M 10 x 1,50	10,4mm	Nº13	Nº13	25PCS	
			M 12 x 1,75	12,4mm	Nº15	Nº15	10PCS	
			Especial para velas →	M 14 x 1,25		Nº17		
KC754	UNC 1/4 a 1/2	115	1/4 x 20	6,7mm	Nº9	Nº9	25PCS	297,70
			5/16 x 18	8,3mm	Nº10	Nº11	25PCS	
			3/8 x 16	9,9mm	Nº12	Nº12	25PCS	
			7/16 x 14	11,6mm	Nº14	Nº14	10PCS	
			1/2 x 13	13mm	Nº15	Nº15	10PCS	
KC755	UNF 1/4 a 1/2	115	1/4 x 28	6,7mm	Nº9	Nº9	25PCS	297,70
			5/16 x 24	8,3mm	Nº11	Nº11	25PCS	
			3/8 x 24	9,8mm	Nº13	Nº13	25PCS	
			7/16 x 20	11,5mm	Nº14	Nº14	10PCS	
			1/2 x 20	13mm	Nº15	Nº15	10PCS	
KC756	BSW 1/4 a 1/2	115	1/4 x 20	6,7mm	Nº9	Nº9	25PCS	297,70
			5/16 x 18	8,3mm	Nº10	Nº11	25PCS	
			3/8 x 16	9,9mm	Nº12	Nº12	25PCS	
			7/16 x 14	11,5mm	Nº14	Nº14	10PCS	
			1/2 x 12	13mm	Nº15	Nº15	10PCS	
KC757	BSF 1/4 a 1/2	115	1/4 x 26	6,6mm	Nº9	Nº9	25PCS	297,70
			5/16 x 22	8,3mm	Nº11	Nº11	25PCS	
			3/8 x 20	9,9mm	Nº12	Nº12	25PCS	
			7/16 x 18	11,5mm	Nº14	Nº14	10PCS	
			1/2 x 16	13mm	Nº15	Nº15	10PCS	

MACHOS K-COIL FORMA D ISO 1/4H

HSS K-COIL TAPS

TARAUDS K-COIL HSS

HSS



Rosca métrica HSS

CÓDIGO	Medida	PCS	€
KC400	M 2 x 0,40	1	12,90
KC401	M 2,5 x 0,45	1	12,90
KC514	M 3 x 0,50	1	11,14
KC403	M 3,5 x 0,60	1	10,02
KC404	M 4 x 0,70	1	10,02
KC405	M 5 x 0,80	1	10,02
KC406	M 6 x 1,00	1	10,02
KC407	M 7 x 1,00	1	12,45
KC408	M 8 x 1,00	1	12,45
KC409	M 8 x 1,25	1	12,45
KC410	M 9 x 1,25	1	15,22
KC411	M 10 x 1,00	1	15,22
KC412	M 10 x 1,25	1	15,22
KC413	M 10 x 1,50	1	15,22
KC414	M 11 x 1,50	1	17,30
KC415	M 12 x 1,00	1	20,75
KC416	M 12 x 1,25	1	21,10
KC417	M 12 x 1,50	1	21,10
KC418	M 12 x 1,75	1	17,30
KC419	M 14 x 1,00	1	24,05
KC420	M 14 x 1,25	1	24,05
KC421	M 14 x 1,50	1	24,05
KC422	M 14 x 2,00	1	24,05
KC423	M 16 x 1,50	1	28,89
KC424	M 16 x 2,00	1	28,89
KC425	M 18 x 1,50	1	36,32
KC426	M 18 x 2,00	1	36,32
KC427	M 18 x 2,50	1	36,32
KC428	M 20 x 1,50	1	39,95
KC429	M 20 x 2,00	1	39,95
KC430	M 20 x 2,50	1	39,95
KC431	M 22 x 1,50	1	46,00
KC432	M 22 x 2,00	1	46,00
KC433	M 22 x 2,50	1	46,00
KC434	M 24 x 1,50	1	58,12
KC435	M 24 x 2,00	1	58,12
KC436	M 24 x 3,00	1	58,12

Outras medidas sob consulta



Macho K-Coil Combi (especial para velas) Rosca Métrica / Rosca métrica fina

CÓDIGO	Medida	PCS	€
KC550	M 6 x 1,00	1	19,70
KC551	M 8 x 1,25	1	19,70
KC552	M 10 x 1,00	1	24,90
KC553	M 10 x 1,50	1	24,90
KC554	M 12 x 1,25	1	35,82
KC555	M 14 x 1,25	1	41,55
KC556	M 18 x 1,50	1	59,46



Rosca UNC - UNF - BSW - BSF - BSP em HSS

CÓDIGO	Medida	PCS	€
KC454	UNC 1/2 x 13	1	19,54
KC455	UNC 1/4 x 20	1	11,33
KC456	UNC 3/8 x 16	1	12,90
KC457	UNC 5/16 x 18	1	12,31
KC458	UNC 7/16 x 14	1	17,19
KC459	UNC 9/16 x 12	1	32,43
KC460	UNC 5/8 x 11	1	40,00
KC461	UNC 3/4 x 10	1	48,65
KC462	UNC 7/8 x 9	1	56,66
KC463	UNC 1" x 8	1	56,66
KC469	UNF 1/2 x 20	1	20,33
KC470	UNF 1/4 x 28	1	11,33
KC471	UNF 3/8 x 24	1	12,90
KC472	UNF 5/16 x 24	1	12,31
KC473	UNF 7/16 x 20	1	17,19
KC474	UNF 9/16 x 18	1	32,43
KC475	UNF 5/8 x 18	1	40,05
KC476	UNF 3/4 x 16	1	48,65
KC477	UNF 7/8 x 14	1	56,66
KC478	UNF 1" x 12	1	56,66
KC483	BSW 1/8 x 40	1	11,33
KC484	BSW 3/16 x 24	1	11,33
KC485	BSW 1/2 x 12	1	19,54
KC486	BSW 1/4 x 20	1	11,33
KC487	BSW 3/8 x 16	1	12,90
KC488	BSW 5/16 x 18	1	12,90
KC489	BSW 7/16 x 14	1	17,19
KC490	BSW 9/16 x 12	1	32,43
KC491	BSW 5/8 x 11	1	40,05
KC492	BSW 3/4 x 10	1	48,65
KC493	BSW 7/8 x 9	1	56,66
KC494	BSW 1" x 8	1	56,66
KC495	BSF 3/16 x 32	1	11,88
KC496	BSF 1/2 x 16	1	19,54
KC497	BSF 1/4 x 26	1	11,33
KC498	BSF 3/8 x 20	1	12,90
KC499	BSF 5/16 x 22	1	12,90
KC500	BSF 7/16 x 18	1	17,19
KC501	BSF 9/16 x 16	1	34,00
KC502	BSF 5/8 x 14	1	41,98
KC503	BSF 3/4 x 12	1	50,99
KC504	BSF 7/8 x 11	1	59,38
KC505	BSF 1" x 10	1	59,38
KC506	BSP 1/8 x 28	1	55,44
KC507	BSP 1/4 x 19	1	72,77
KC508	BSP 3/8 x 19	1	90,09
KC509	BSP 1/2 x 14	1	106,26
KC510	BSP 5/8 x 14	1	145,53
KC511	BSP 3/4 x 14	1	215,99
KC512	BSP 7/8 x 14	1	272,58
KC513	BSP 1" x 11	1	336,11

Outras medidas sob consulta

ACESSÓRIOS K-COIL

K-COIL ACCESSORIES

ACCESSOIRES POUR RÉTABLIR TARAUDAGES ENDOMMAGÉES

HSS

Utensílio Manual para Inserto K-Coil

CÓDIGO	Nº	Rosca	PCS	€
KC800	2	M 2	1	12,43
KC801	3	M 2,5	1	12,43
KC802	4	M 3	1	11,87
KC803	5	M 3,5	1	11,87
KC804	6	M 4	1	11,87
KC805	8	M 5	1	11,87
KC806	9	M 6	1	11,87
KC807	10	M 7	1	13,55
KC808	11	M 8	1	13,55
KC809	12	M 9	1	14,59
KC810	13	M 10	1	14,59
KC811	14	M 11	1	17,08
KC812	15	M 12	1	17,08
KC813	16	M 14	1	19,90
KC814	17	M 14	1	19,90
KC815	18	M 16	1	22,51
KC816	20	M 18	1	22,51
KC817	21	M 20	1	22,51
KC818	22	M 22	1	28,34
KC819	23	M 24	1	28,34



Utensílio para Rotura do Perno

CÓDIGO	Nº	Rosca	PCS	€
KC300	2	M 2	1	4,70
KC301	3	M 2,5	1	4,70
KC302	4	M 3	1	4,70
KC303	5	M 3,5	1	4,70
KC304	6	M 4	1	4,70
KC305	8	M 5	1	4,70
KC306	9	M 6	1	4,70
KC307	10	M 7	1	5,28
KC308	11	M 8	1	5,28
KC309	12	M 9	1	5,28
KC310	13	M 10	1	6,34
KC311	14	M 11	1	6,34



Extrator K-Coil

CÓDIGO	Nº	Rosca	PCS	€
KC880	2	M 3 - 10	1	27,79
KC881	3	M 11 - 24	1	33,80



INSERTO ROSCADO K-COIL DIN8140-ISO 2/6H INOX

K-COIL THREAD INSERT

RESSORTS FILETÉES EN ACIER INOXIDABLE

INOX



Medida	CÓDIGO	PCS	€	CÓDIGO	PCS	€	CÓDIGO	PCS	€	CÓDIGO	PCS	€	CÓDIGO	PCS	€
M 2 x 0,40	KC001	100	0,70	KC043	100	0,92	KC161	100	1,08	KC221	25	1,29	KC261	25	1,41
M 2,5 x 0,45	KC002	100	0,22	KC044	100	0,23	KC162	100	0,24	KC222	25	1,29	KC262	25	1,41
M 3 x 0,50	KC003	100	0,22	KC045	100	0,23	KC163	100	0,24	KC223	25	1,29	KC263	25	1,41
M 3,5 x 0,60	KC004	100	0,24	KC046	100	0,26	KC164	100	0,28	KC224	25	1,29	KC264	25	1,41
M 4 x 0,70	KC005	100	0,22	KC047	100	0,23	KC165	100	0,24	KC225	25	0,50	KC265	25	0,54
M 5 x 0,80	KC006	100	0,24	KC048	100	0,20	KC166	100	0,28	KC226	25	0,50	KC266	25	0,53
M 6 x 1,00	KC007	100	0,26	KC049	100	0,22	KC167	100	0,31	KC227	25	0,61	KC267	25	0,65
M 7 x 1,00	KC008	100	0,29	KC050	100	0,35	KC168	100	0,39	KC228	25	0,78	KC268	25	0,79
M 8 x 1,00	KC009	100	0,31	KC051	100	0,31	KC169	100	0,41	KC229	25	0,66	KC269	25	0,88
M 8 x 1,25	KC010	100	0,28	KC052	100	0,28	KC170	100	0,39	KC230	25	0,76	KC270	25	1,00
M 9 x 1,25	KC011	100	0,39	KC053	100	0,52	KC171	100	0,52	KC231	10	1,05	KC271	10	1,28
M 10 x 1,00	KC012	50	0,35	KC054	50	0,39	KC172	50	0,44	KC232	10	0,86	KC272	10	1,14
M 10 x 1,25	KC013	50	0,35	KC055	50	0,39	KC173	50	0,44	KC233	10	0,99	KC273	10	1,32
M 10 x 1,50	KC014	50	0,39	KC056	50	0,39	KC174	50	0,44	KC234	10	1,22	KC274	10	1,53
M 11 x 1,50	KC015	50	0,58	KC057	50	0,65	KC175	50	0,69	KC235	10	1,61	KC275	10	1,53
M 12 x 1,00	KC016	50	0,52	KC058	50	0,61	KC176	50	0,67	KC236	10	1,23	KC276	10	1,42
M 12 x 1,25	KC017	50	0,52	KC059	50	0,61	KC177	50	0,67	KC237	10	1,29	KC277	10	1,42
M 12 x 1,50	KC018	50	0,52	KC061	50	0,61	KC179	50	0,67	KC238	10	1,31	KC278	10	1,64
M 12 x 1,75	KC019	50	0,52	KC062	50	0,61	KC180	50	0,67	KC239	10	1,67	KC279	10	1,99
M 14 x 1,00	KC020	25	0,94	KC063	25	0,97	KC181	25	1,13	KC240	10	1,57	KC280	10	1,84
M 14 x 1,25	KC021	25	0,78	KC064	25	0,90	KC182	25	0,88	KC241	10	1,52	KC281	10	2,31
M 14 x 1,50	KC022	25	0,78	KC068	25	0,90	KC186	25	0,92	KC242	10	1,82	KC282	10	2,33
M 14 x 2,00	KC023	25	0,78	KC069	25	0,90	KC187	25	0,92	KC243	10	2,45	KC283	10	3,01
M 16 x 1,50	KC024	25	1,07	KC070	25	1,11	KC188	25	1,36	KC244	10	2,57	KC284	10	2,90
M 16 x 2,00	KC025	25	1,07	KC071	25	1,11	KC189	25	1,36	KC245	10	2,74	KC285	10	4,33
M 18 x 1,50	KC026	25	1,55	KC072	25	1,79	KC190	25	2,44	KC246	10	1,85	KC286	10	2,01
M 18 x 2,00	KC027	25	1,55	KC074	25	1,79	KC192	25	2,44	KC247	10	2,61	KC287	10	3,15
M 18 x 2,50	KC028	25	1,55	KC075	25	1,79	KC193	25	2,44	KC248	10	2,61	KC288	10	3,14
M 20 x 1,50	KC029	25	1,79	KC076	25	2,28	KC194	25	2,93	KC249	10	2,04	KC289	10	2,87
M 20 x 2,00	KC030	25	1,79	KC077	25	2,28	KC195	25	2,93	KC250	10	3,22	KC290	10	3,88
M 20 x 2,50	KC031	25	1,94	KC078	25	2,28	KC196	25	2,93	KC251	10	3,39	KC291	10	4,00
M 22 x 1,50	KC032	25	1,94	KC079	25	2,44	KC197	25	3,08	KC252	10	2,90	KC292	10	3,50
M 22 x 2,00	KC033	25	1,94	KC080	25	2,71	KC198	25	3,08	KC253	10	4,41	KC293	10	5,39
M 22 x 2,50	KC034	25	1,94	KC081	25	2,44	KC199	25	3,37	KC254	10	4,22	KC294	10	6,07
M 24 x 1,50	KC035	25	2,44	KC082	25	2,60	KC200	25	3,25	KC255	10	4,49	KC295	10	5,03
M 24 x 2,00	KC036	25	2,44	KC083	25	2,60	KC201	25	3,25	KC256	10	5,05	KC296	10	5,82
M 24 x 3,00	KC037	25	2,44	KC084	25	3,95	KC202	25	5,31	KC257	10	6,34	KC297	10	9,37

Outras medidas sob consulta

Instruções de uso

1. Furar a rosca danificada com uma broca.
2. Roscar com um macho K-Coil.
3. Biselar o diâmetro exterior a 90° e retirar a rebarba.
4. Colocar o inserto com a ajuda do utensílio manual.
5. No caso de furos passantes use o utensílio para rotura do perno.



INSERTO ROSCADO K-COIL DIN8140-ISO 2/6H INOX

K-COIL THREAD INSERT

RESSORTS FILETÉES EN ACIER INOXIDABLE

INOX



CÓDIGO		Medida			PCS	€
KC102	UNC	1/2	x	13	10	1,36
KC103	UNC	1/4	x	20	10	0,47
KC104	UNC	3/8	x	16	10	0,78
KC105	UNC	5/16	x	18	10	0,62
KC106	UNC	7/16	x	14	10	1,20
KC107	UNC	9/16	x	12	10	3,47
KC108	UNC	5/8	x	11	10	3,15
KC109	UNC	3/4	x	10	10	3,72
KC110	UNC	7/8	x	9	10	5,46
KC111	UNC	1"	x	8	10	5,46
KC117	UNF	1/2	x	20	10	0,90
KC118	UNF	1/4	x	28	10	0,47
KC119	UNF	3/8	x	24	10	0,67
KC120	UNF	5/16	x	24	10	0,55
KC121	UNF	7/16	x	20	10	0,90
KC122	UNF	9/16	x	18	10	1,88
KC123	UNF	5/8	x	18	10	1,88
KC124	UNF	3/4	x	16	10	4,32
KC125	UNF	7/8	x	14	10	6,23
KC126	UNF	1"	x	12	10	6,23
KC130	BSW	1/8	x	40	100	1,11
KC131	BSW	3/16	x	24	100	1,11
KC132	BSW	1/2	x	12	100	1,42
KC133	BSW	1/4	x	20	100	0,46
KC134	BSW	3/8	x	16	100	0,92
KC135	BSW	5/16	x	18	100	0,55
KC136	BSW	7/16	x	14	100	1,14
KC137	BSW	9/16	x	12	100	3,63
KC138	BSW	5/8	x	11	50	3,63
KC139	BSW	3/4	x	10	25	4,32
KC140	BSW	7/8	x	9	10	6,05
KC141	BSW	1"	x	8	10	6,92
KC142	BSF	3/16	x	32	100	1,11
KC143	BSF	1/2	x	16	100	2,10
KC144	BSF	1/4	x	26	100	0,77
KC145	BSF	3/8	x	20	100	1,18
KC146	BSF	5/16	x	22	100	0,87
KC147	BSF	7/16	x	18	100	2,01
KC148	BSF	9/16	x	16	100	3,47
KC149	BSF	5/8	x	14	50	3,47
KC150	BSF	3/4	x	12	50	4,32
KC151	BSF	7/8	x	11	25	6,05
KC152	BSF	1"	x	10	10	6,05
KC153	BSP	1/8	x	28	100	0,69
KC154	BSP	1/4	x	19	100	1,02
KC155	BSP	3/8	x	19	50	1,21
KC156	BSP	1/2	x	14	25	1,56
KC157	BSP	5/8	x	14	10	3,89
KC158	BSP	3/4	x	14	5	3,89
KC159	BSP	7/8	x	14	5	11,95
KC160	BSP	1"	x	11	5	11,95

Prazo de entrega sujeito a confirmação

INSERTOS AUTO ROSCANTES DIN8140-ISO 2/6H

MASTERFIX CASES
JEUX MASTERFIX

Aço Temperado



Inserto auto-roscante

CÓDIGO	Medida	PCS	€
KCA001	M2 x 0,40 x 6mm	10	0,74
KCA002	M2,5 x 0,45 x 6mm	10	0,74
KCA003	M3 x 0,50 x 6mm	10	0,27
KCA004	M4 x 0,70 x 8mm	10	0,44
KCA005	M5 x 0,80 x 10mm	10	0,50
KCA006	M6 x 1,00 x 12mm	10	0,57
KCA007	M6 x 1,00 x 14mm	10	0,63
KCA008	M8 x 1,25 x 15mm	10	0,84
KCA009	M10 x 1,50 x 18mm	5	1,26
KCA010	M12 x 1,50 x 22mm	5	2,04
KCA011	M12 x 1,75 x 22mm	5	2,04
KCA012	M14 x 1,50 x 24mm	5	4,39
KCA013	M14 x 2,00 x 24mm	5	4,39
KCA014	M16 x 2,00 x 22mm	5	4,39
KCA015	M18 x 2,50 x 24mm	5	5,33
KCA016	M20 x 2,50 x 27mm	5	5,54
KCA017	M22 x 2,50 x 30mm	5	5,54
KCA018	M24 x 3,00 x 30mm	5	11,30



MASTERFIX - M3 a M12

Composição 50 peças

Utensílio para inserts com cabo hexagonal (1 peça de cada):
M3x0,5 - M4x0,7 - M5x0,8 - M6x1,0 - M8x1,25 - M10x1,5 - M12x1,75
Brocas (1 peça de cada):
4,70 - 6,10 - 7,50 - 9,30 - 11,40 - 13,25 - 15,25
Insertos auto-roscantes (5 peças de cada):
M3x0,5 - M4x0,7 - M5x0,8 - M6x1,0 - M8x1,25 - M10x1,5 - M12x1,75
Porca / adaptador hexagonal (1 peça)

CÓDIGO	€
KC900	218,93

MASTERFIX - M5 a M12

Composição 36 peças

Utensílio para inserts com cabo hexagonal (1 peça de cada):
M5x0,8 - M6x1,0 - M8x1,25 - M10x1,5 - M12x1,75
Brocas (1 peça de cada):
7,50 - 9,30 - 11,40 - 13,25 - 15,25
Insertos auto-roscantes (5 peças de cada):
M5x0,8 - M6x1,0 - M8x1,25 - M10x1,5 - M12x1,75
Porca / adaptador hexagonal (1 peça)

CÓDIGO	€
KC901	145,53

MASTERFIX - M3 a M10

Composição 43 peças

Utensílio para inserts com cabo hexagonal (1 peça de cada):
M3x0,5 - M4x0,7 - M5x0,8 - M6x1,0 - M8x1,25 - M10x1,5
Brocas (1 peça de cada):
4,70 - 6,10 - 7,50 - 9,30 - 11,40 - 13,25
Insertos auto-roscantes (5 peças de cada):
M3x0,5 - M4x0,7 - M5x0,8 - M6x1,0 - M8x1,25 - M10x1,5
Porca / adaptador hexagonal (1 peça)

CÓDIGO	€
KC902	144,17



Composição:

- 1 x Broca HSS
- 1 x Ferramenta de Inserção de Insertos
- 1 x Porca adaptador para ferramentas de inserção
- 5 x Insertos Auto Roscantes

Jogo Inserto Auto-Roscante

CÓDIGO	Medida	PCS	€
KCA200	M3 x 0,5	1	29,39
KCA201	M4 x 0,7	1	29,39
KCA202	M5 x 0,8	1	29,39
KCA203	M6 x 1,0	1	30,88
KCA204	M8 x 1,25	1	32,60
KCA205	M10 x 1,5	1	40,83
KCA206	M12 x 1,75	1	47,34



Ferramenta de Inserção de Insertos Auto-Roscantes

CÓDIGO	Medida	Comprimento (mm)	Ø Broca Recomendada	PCS	€
KCA101	M3 x 0,5	46	4,7	1	13,14
KCA102	M4 x 0,7	48	6,1	1	13,14
KCA103	M5 x 0,8	57	7,5	1	13,14
KCA104	M6 x 1,0	62	9,3	1	13,14
KCA105	M8 x 1,25	72	11,3	1	16,03
KCA106	M10 x 1,5	82	13,25	1	17,89
KCA107	M12 x 1,75	92	15,25	1	19,74



Porca adaptador para ferramenta de inserção

CÓDIGO	Medida	Direção	PCS	€
KCA100	M3 x 0,5	Direita	1	9,91

SERRAS CIRCULARES PARA METAIS NÃO FERROSOS HSS, HSS-CO E TIN

CIRCULAR SAWS FOR NON-FERROUS METALS

SCIES CIRCULAIRES POUR ACIERS SPÉCIAUX



HSS



HSS-CO



TIN



Serras Circulares HSS

Ø	Esp.	Furo	Nºdentes	PCS
200	1,8	32	160	1
225	1,9	32	180	1
250	1,6	32	200	1
250	2,0	32	200	1
250	2,0	40	200	1
250	2,5	32	200	1
250	2,5	40	200	1
275	2,0	32	220	1
275	2,0	40	220	1
275	2,5	32	220	1
275	2,5	40	220	1
300	2,0	32	220	1
300	2,0	40	220	1
300	2,5	32	220	1
300	2,5	40	220	1
315	2,0	32	220	1
315	2,0	40	220	1
315	2,5	32	220	1
315	2,5	40	220	1
350	2,5	32	280	1
350	2,5	40	280	1
350	2,5	50	280	1
350	3,0	32	280	1
350	3,0	40	280	1
350	3,0	50	280	1
370	3,0	32	280	1
370	3,0	40	280	1
370	3,0	50	280	1
400	3,0	32	310	1
400	3,0	40	310	1
400	3,0	50	310	1

HSS Vapo

CÓDIGO	€
MX4000	57,63
MX4001	63,18
MX4002	69,20
MX4003	72,90
MX4004	72,90
MX4005	82,78
MX4006	82,78
MX4007	84,16
MX4008	84,16
MX4009	89,23
MX4010	89,23
MX4011	97,27
MX4012	97,27
MX4013	107,83
MX4014	107,83
MX4015	123,46
MX4016	123,46
MX4017	124,55
MX4018	124,55
MX4019	170,94
MX4020	170,94
MX4021	170,94
MX4022	177,08
MX4023	177,08
MX4024	177,08
MX4025	232,49
MX4026	232,49
MX4027	232,49
MX4028	269,88
MX4029	269,88
MX4030	269,88

HSS-Co 5% Vapo

CÓDIGO	€
MX4200	81,35
MX4201	87,64
MX4202	91,39
MX4203	90,39
MX4204	101,15
MX4205	101,15
MX4206	116,92
MX4207	116,92
MX4208	118,89
MX4209	118,89
MX4210	140,83
MX4211	140,83
MX4212	143,20
MX4213	143,20
MX4214	156,60
MX4215	156,60
MX4216	159,17
MX4217	159,17
MX4218	186,13
MX4219	186,13
MX4220	186,13
MX4221	205,46
MX4222	205,46
MX4223	205,46
MX4224	274,57
MX4225	274,57
MX4226	274,57
MX4227	308,65
MX4228	308,65
MX4229	308,65

HSS TIN

CÓDIGO	€
MX4400	75,74
MX4401	84,23
MX4402	119,06
MX4403	92,95
MX4404	92,95
MX4405	100,54
MX4406	100,54
MX4407	152,99
MX4408	152,99
MX4409	117,77
MX4410	117,77
MX4411	184,06
MX4412	184,06
MX4413	143,92
MX4414	143,92
MX4415	199,90
MX4416	199,90
MX4417	161,11
MX4418	161,11
MX4419	192,81
MX4420	192,81
MX4421	192,81
MX4422	252,05
MX4423	252,05
MX4424	252,05
MX4425	268,54
MX4426	268,54
MX4427	268,54
MX4428	299,55
MX4429	299,55
MX4430	299,55

Alguns tipos de dentado

Outros Diâmetros e Dentados sob consulta

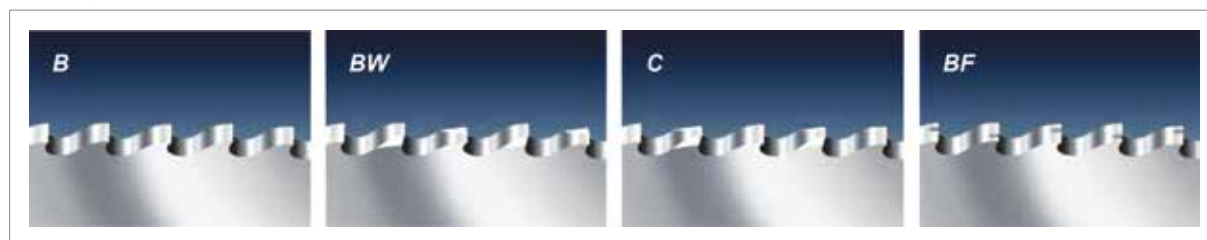

SERRAS CIRCULARES PARA AÇOS ESPECIAIS EM TIALN E TICN

CIRCULAR SAWS FOR SPECIAL STEEL

SCIÉS CIRCULAIRES POUR ACIERS SPÉCIAUX

TIALN

TICN



Serras Circulares - PVD

Ø	Esp.	Furo	Nºdentes	PCS
250	1,6	32	200	1
250	2,0	32	200	1
250	2,0	40	200	1
250	2,5	32	200	1
250	2,5	40	200	1
275	2,0	32	220	1
275	2,0	40	220	1
275	2,5	32	220	1
275	2,5	40	220	1
300	2,0	32	220	1
300	2,0	40	220	1
300	2,5	32	220	1
300	2,5	40	220	1
315	2,0	32	220	1
315	2,0	40	220	1
315	2,5	32	220	1
315	2,5	40	220	1
350	2,5	32	280	1
350	2,5	40	280	1
350	2,5	50	280	1
350	3,0	32	280	1
350	3,0	40	280	1
350	3,0	50	280	1
370	3,0	32	280	1
370	3,0	40	280	1
370	3,0	50	280	1
400	3,0	32	310	1
400	3,0	40	310	1
400	3,0	50	310	1

TIALN - PVD INOX

CÓDIGO	€
MX8000	134,93
MX8001	137,30
MX8002	137,30
MX8003	147,15
MX8004	147,15
MX8005	157,17
MX8006	157,17
MX8007	172,71
MX8008	172,71
MX8009	201,55
MX8010	201,55
MX8011	203,27
MX8012	203,27
MX8013	219,99
MX8014	219,99
MX8015	221,73
MX8016	221,73
MX8017	262,05
MX8018	262,05
MX8019	262,05
MX8020	273,87
MX8021	273,87
MX8022	273,87
MX8023	355,92
MX8024	355,92
MX8025	355,92
MX8026	404,62
MX8027	404,62
MX8028	404,62

TICN - PVD

CÓDIGO	€
MX8400	107,24
MX8401	109,32
MX8402	109,32
MX8403	117,87
MX8404	117,87
MX8405	125,49
MX8406	125,49
MX8407	137,92
MX8408	137,92
MX8409	161,47
MX8410	161,47
MX8411	162,99
MX8412	162,99
MX8413	177,10
MX8414	177,10
MX8415	178,60
MX8416	178,60
MX8417	210,50
MX8418	210,50
MX8419	210,50
MX8420	221,17
MX8421	221,17
MX8422	221,17
MX8423	289,85
MX8424	289,85
MX8425	289,85
MX8426	329,18
MX8427	329,18
MX8428	329,18

Método PVD:

- Aumenta a dureza superficial.
- Diminui o atrito.
- Limita a corrosão e oxidação.
- Reduz o tempo de trabalho.

- Para materiais extra duros e aços inoxidáveis.

- Para condições difíceis de corte a alta velocidade.

- Velocidade de corte em mais de 10% a 25% que a serra normal vaporizada.

- Redução do tempo de corte na mesma, proporção 10% a 25%.

-Serras para corte de alta produção em materiais inoxidáveis de difícil mecanização (AISI-304, AISI306).

- Excelentes resultados em máquinas automáticas e cortes muito rápidos, económicos e com excelente acabamento.

Alguns tipos de dentado

NB: Alteração dos dentes tem um acréscimo de 10% do valor * Outros diâmetros sob consulta

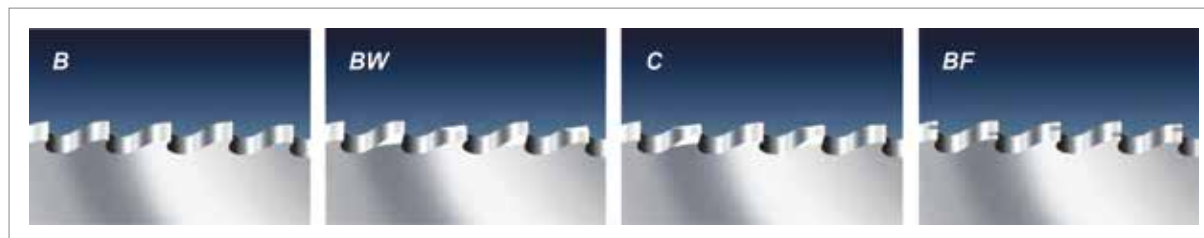

SERRAS CIRCULARES PARA CORTE DE METAIS, FORMA A - DIN1837 HSS

CIRCULAR SAWS FOR METAL CUTTING, SHAPE A - DIN1837 HSS

SCIES CIRCULAIRES POUR LA COUPE DES MÉTAUX, FORME A - DIN1837 HSS

CÓDIGO	Ø	Esp.	Furo	Dent.	PCS	€
SE0002	20	0,25	5	64	1	14,87
SE0003	20	0,3	5	64	1	13,73
SE0004	20	0,4	5	64	1	13,50
SE0005	20	0,5	5	48	1	13,39
SE0006	20	0,6	5	48	1	13,27
SE0007	20	0,8	5	48	1	13,05
SE0008	20	1	5	40	1	13,50
SE0009	20	1,2	5	40	1	14,30
SE0017	20	1,5	5	40	1	14,35
SE0010	20	1,6	5	40	1	15,79
SE0011	20	2	5	32	1	16,13
SE0012	20	2,5	5	32	1	17,16
SE0013	20	3	5	32	1	18,41
SE0014	20	4	5	24	1	24,37
SE0015	20	5	5	24	1	28,49
SE0016	20	6	5	24	1	32,49
SE0050	25	0,2	8	80	1	15,79
SE0051	25	0,25	8	80	1	15,44
SE0052	25	0,3	8	80	1	14,3
SE0053	25	0,4	8	64	1	14,19
SE0054	25	0,5	8	64	1	13,84
SE0055	25	0,6	8	64	1	13,73
SE0056	25	0,8	8	48	1	13,27
SE0057	25	1	8	48	1	13,84
SE0058	25	1,2	8	48	1	14,87
SE0066	25	1,5	8	40	1	14,66
SE0059	25	1,6	8	40	1	16,13
SE0060	25	2	8	40	1	16,82
SE0061	25	2,5	8	40	1	18,3
SE0062	25	3	8	32	1	21,4
SE0063	25	4	8	32	1	25,85
SE0064	25	5	8	32	1	30,21
SE0065	25	6	8	24	1	33,98
SE0100	32	0,2	8	100	1	16,02
SE0101	32	0,25	8	100	1	15,79
SE0102	32	0,3	8	80	1	14,64
SE0103	32	0,4	8	80	1	14,41
SE0104	32	0,5	8	80	1	14,19
SE0105	32	0,6	8	64	1	14,07
SE0106	32	0,8	8	64	1	13,62
SE0107	32	1	8	64	1	14,41
SE0108	32	1,2	8	48	1	15,68
SE0116	32	1,5	8	48	1	16,48
SE0109	32	1,6	8	48	1	16,48
SE0110	32	2	8	48	1	17,73
SE0111	32	2,5	8	40	1	20,82
SE0112	32	3	8	40	1	23,68
SE0113	32	4	8	40	1	27,57
SE0114	32	5	8	32	1	32,71
SE0115	32	6	8	32	1	35,57
SE0150	40	0,2	10	128	1	17,96
SE0151	40	0,25	10	100	1	17,50
SE0152	40	0,3	10	100	1	16,82
SE0153	40	0,4	10	100	1	16,48
SE0154	40	0,5	10	80	1	16,36
SE0155	40	0,6	10	80	1	16,13
SE0156	40	0,8	10	80	1	15,55
SE0157	40	1	10	64	1	15,91

CÓDIGO	Ø	Esp.	Furo	Dent.	PCS	€
SE0158	40	1,2	10	64	1	15,92
SE0166	40	1,5	10	64	1	17,16
SE0159	40	1,6	10	64	1	17,16
SE0160	40	2	10	48	1	18,54
SE0161	40	2,5	10	48	1	22,31
SE0162	40	3	10	48	1	25,85
SE0163	40	4	10	40	1	30,32
SE0164	40	5	10	40	1	37,52
SE0165	40	6	10	40	1	41,42
SE0200	50	0,2	13	128	1	20,93
SE0201	50	0,25	13	128	1	20,7
SE0202	50	0,3	13	128	1	19,11
SE0203	50	0,4	13	100	1	18,54
SE0204	50	0,5	13	100	1	17,96
SE0205	50	0,6	13	100	1	17,27
SE0207	50	0,8	13	80	1	16,48
SE0208	50	1	13	80	1	16,82
SE0209	50	1,2	13	80	1	17,5
SE0210	50	1,5	13	64	1	18,99
SE0211	50	1,6	13	64	1	18,99
SE0212	50	2	13	64	1	20,48
SE0213	50	2,5	13	64	1	22,42
SE0214	50	3	13	48	1	26,08
SE0216	50	4	13	48	1	30,89
SE0217	50	5	13	48	1	40,04
SE0218	50	6	13	40	1	45,87
SE0250	63	0,25	16	160	1	22,65
SE0251	63	0,3	16	128	1	21,51
SE0252	63	0,4	16	128	1	20,93
SE0253	63	0,5	16	128	1	19,79
SE0254	63	0,6	16	100	1	21,14
SE0256	63	0,8	16	100	1	18,3
SE0257	63	1	16	100	1	18,65
SE0258	63	1,2	16	80	1	19,22
SE0259	63	1,5	16	80	1	20,93
SE0260	63	1,6	16	80	1	20,93
SE0261	63	2	16	80	1	22,42
SE0262	63	2,5	16	64	1	24,26
SE0263	63	3	16	64	1	26,77
SE0265	63	4	16	64	1	32,37
SE0266	63	5	16	48	1	41,18
SE0267	63	6	16	48	1	46,56
SE0300	80	0,3	22	160	1	24,60
SE0301	80	0,4	22	160	1	24,26
SE0302	80	0,5	22	128	1	23,11
SE0303	80	0,6	22	128	1	22,99
SE0305	80	0,8	22	128	1	21,51
SE0306	80	1	22	100	1	22,08
SE0307	80	1,2	22	100	1	22,99
SE0308	80	1,5	22	100	1	23,79
SE0309	80	1,6	22	100	1	23,79
SE0310	80	2	22	80	1	25,85
SE0311	80	2,5	22	80	1	30,21
SE0312	80	3	22	80	1	33,29
SE0314	80	4	22	64	1	40,15
SE0315	80	5	22	64	1	49,53
SE0316	80	6	22	64	1	55,25

CÓDIGO	Ø	Esp.	Furo	Dent.	PCS	€
SE0350	100	0,5	22	160	1	26,88
SE0351	100	0,6	22	160	1	26,42
SE0352	100	0,8	22	128	1	25,17
SE0353	100	1	22	128	1	25,63
SE0354	100	1,2	22	128	1	26,42
SE0355	100	1,5	22	100	1	30,89
SE0356	100	1,6	22	100	1	30,89
SE0357	100	2	22	100	1	34,66
SE0358	100	2,5	22	100	1	38,9
SE0359	100	3	22	80	1	41,99
SE0361	100	4	22	80	1	53,09
SE0362	100	5	22	80	1	60,52
SE0366	100	6	22	64	1	70,25
SE0400	125	0,6	22	160	1	39,01
SE0401	125	0,8	22	160	1	36,5
SE0402	125	1	22	160	1	36,84
SE0403	125	1,2	22	128	1	37,29
SE0404	125	1,5	22	128	1	38,43
SE0405	125	1,6	22	128	1	38,43
SE0406	125	2	22	128	1	40,27
SE0407	125	2,5	22	100	1	42,9
SE0408	125	3	22	100	1	47,59
SE0409	125	4	22	100	1	69,89
SE0410	125	5	22	80	1	81,57
SE0411	125	6	22	80	1	91,63
SE0450	160	1	32	160	1	63,26
SE0451	160	1,2	32	160	1	64,75
SE0452	160	1,5	32	160	1	66,81
SE0453	160	1,6	32	160	1	66,81
SE0454	160	2	32	128	1	69,44
SE0455	160	2,5	32	128	1	73,56
SE0456	160	3	32	128	1	85,8
SE0457	160	4	32	100	1	113,26
SE0458	160	5	32	100	1	135,45
SE0459	160	6	32	100	1	152,04
SE0500	200	1	32	200	1	76,08
SE0501	200	1,2	32	200	1	79,05
SE0502	200	1,5	32	160	1	83,85
SE0503	200	1,6	32	160	1	83,85
SE0504	200	2	32	160	1	87,86
SE0505	200	2,5	32	160	1	102,05
SE0506	200	3	32	128	1	113,03
SE0508	200	4	32	128	1	160,16
SE0509	200	5	32	128	1	186,7
SE0510	200	6	32	100	1	216,37

HSS



DIN1837 - Forma do Dente Tipo A

SERRAS CIRCULARES DE SEGMENTOS EM HSS

HSS SEGMENT CIRCULAR SAWS
SCIES CIRCULAIRES À SEGMENTS HSS

HSS



Serras Circulares de Segmentos em HSS

Ø	Esp.	Furo	Nº Seg.	PCS	€
250	4,00	32	12	1	295,47
275	4,00	40	12	1	300,72
315	4,00	40	16	1	373,05
355	4,50	40	16	1	405,43
370	3,50	50	16	1	431,45
400	4,00	50	16	1	468,93
460	4,50	60	18	1	585,15
510	5,50	60	18	1	660,84
560	5,50	70	18	1	692,91
610	6,00	80	20	1	835,57
630	6,00	80	20	1	848,23
660	6,00	80	20	1	946,13
710	6,00	80	24	1	1011,57
760	6,00	80	24	1	1179,54
800	7,00	80	24	1	1266,94
910	7,00	80	30	1	1683,02
1010	8,00	100	30	1	2031,11
1110	8,00	100	36	1	2375,31
1210	8,00	100	36	1	2840,21
1250	9,00	100	36	1	3169,23
1310	9,00	100	36	1	3391,99
1400	9,00	100	36	1	3788,52
1510	10,00	100	36	1	5788,83
1600	11,00	150	40	1	7042,46

Segmentos

€
30,14
31,33
29,90
30,04
32,15
30,04
33,07
34,93
36,45
37,57
37,78
40,92
40,13
42,21
45,66
52,59
52,59
52,59
61,58
63,67
67,83
69,99
78,38
77,00

Número de dentes a indicar Z2 - Z3 - Z4 - Z5 - Z6 - Z8 - Z10 - Z12

Prestamos Assistência Técnica

SERRAS DE PASTILHA COM DENTES EM METAL DURO

CARBIDE TIPPED CIRCULAR SAW BLADES

SCIES À PLAQUETTES AVEC DENTS EN MÉTAL DUR

Alumínio - Dente Positivo

CÓDIGO	Ø	Esp.	Furo	Nºdentes	PCS	€
MSP001	250	3,20	32	80DP	1	99,75
MSP002	250	3,20	30	80DP	1	99,75
MSP003	300	3,20	32	96DP	1	116,10
MSP004	300	3,20	30	96DP	1	116,10
MSP005	350	3,60	32	84DP	1	120,84
MSP006	350	3,60	30	84DP	1	120,84
MSP007	350	3,60	32	108DP	1	138,07
MSP008	350	3,60	30	108DP	1	138,07
MSP009	400	4,00	32	120DP	1	166,86
MSP010	400	4,00	30	120DP	1	166,86
MSP011	420	4,00	30	96DP	1	174,22
MSP012	420	4,00	30	120DP	1	174,22
MSP013	450	4,00	32	128DP	1	210,38
MSP014	450	4,00	30	128DP	1	210,38
MSP015	500	4,20	32	140DP	1	249,70
MSP016	500	4,20	30	140DP	1	164,95
MSP017	550	4,20	30	110DP	1	310,10
MSP018	550	4,20	32	140DP	1	314,09
MSP019	550	4,20	30	140DP	1	314,09
MSP020	600	4,60	32	140DP	1	494,85
MSP021	600	4,60	30	140DP	1	494,85
MSP022	600	4,60	40	140DP	1	494,85

Outras medidas sob consulta (até diâmetro 1000)

Aplicação:

Serras circulares para corte de perfis tubulares de metais não ferrosos, alumínio, PVC, etc.



Alumínio

Alumínio - Dente Negativo

CÓDIGO	Ø	Esp.	Furo	Nºdentes	PCS	€
MSP050	250	3,20	32	80DN	1	99,75
MSP051	250	3,20	30	80DN	1	99,75
MSP052	300	3,20	32	96DN	1	116,10
MSP053	300	3,20	30	96DN	1	116,10
MSP054	350	3,60	32	108DN	1	138,07
MSP055	350	3,60	30	108DN	1	138,07
MSP056	400	4,00	32	120DN	1	166,86
MSP057	400	4,00	30	120DN	1	166,86
MSP058	450	4,00	32	128DN	1	234,94
MSP059	450	4,00	30	128DN	1	234,94
MSP060	500	4,20	32	140DN	1	291,84
MSP061	500	4,20	30	140DN	1	291,84
MSP062	600	4,60	30	140DN	1	509,69

Outras medidas sob consulta

Aplicação:

Serras circulares para corte de perfis tubulares de metais não ferrosos, alumínio, PVC, etc.



Alumínio

METAL DURO

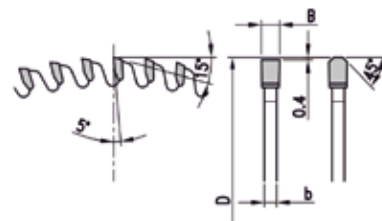

Avanço Automático

METAL DURO

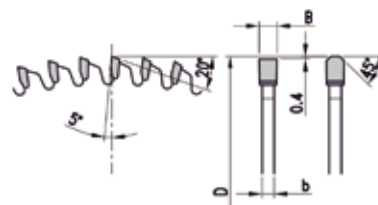

Avanço Manual

SERRAS DE PASTILHA COM DENTES EM METAL DURO

CARBIDE TIPPED CIRCULAR SAW BLADES

SCIES À PLAQUETTES AVEC DENTS EN MÉTAL DUR

Madeira - Dente Alternado

CÓDIGO	Ø	Esp.	Furo	Nºdentes	PCS	€
MSP070	250	3,20	30	40DA	1	60,38
MSP071	250	3,20	30	60DA	1	73,96
MSP072	250	3,20	30	80DA	1	88,23
MSP073	300	3,20	30	48DA	1	65,97
MSP074	300	3,20	30	72DA	1	89,14
MSP075	300	3,20	30	96DA	1	100,09
MSP076	350	3,50	30	54DA	1	92,68
MSP077	350	3,50	30	72DA	1	105,57
MSP078	400	3,50	30	60DA	1	110,71
MSP079	400	3,50	30	96DA	1	142,10
MSP080	450	4,00	30	66DA	1	156,82
MSP081	450	4,00	30	138DA	1	261,34
MSP082	500	4,00	30	72DA	1	194,28
MSP083	500	4,00	30	144DA	1	292,78

Aplicação:

Serras circulares para corte longitudinal e transversal de madeira maciça (macia e dura) e derivados de madeira sem revestimentos.



METAL DURO

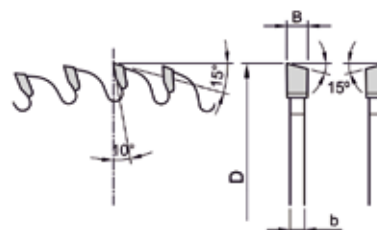

Laminados - Dente Trapezoidal

CÓDIGO	Ø	Esp.	Furo	Nºdentes	PCS	€
MSP090	250	3,20	30	60DP	1	85,46
MSP091	250	3,20	30	80DP	1	99,32
MSP092	300	3,20	30	72DP	1	100,32
MSP093	300	3,20	30	96DP	1	108,88
MSP094	350	3,50	30	84DP	1	128,06
MSP095	350	3,50	30	108DP	1	147,00

Aplicação:

Serras circulares para corte de derivados de madeira com revestimento como MDF, aglomerados, entre outros.



METAL DURO

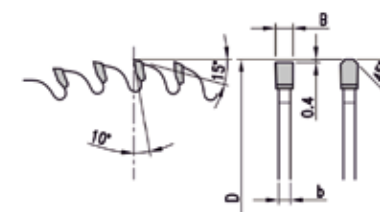

SERRAS CIRCULARES COM DENTES EM METAL DURO

CARBIDE TIPPED CIRCULAR SAW BLADES

SCIES À PLAQUETTES AVEC DENTS EN MÉTAL DUR

Dry Cut (Painéis Sandwich)

CÓDIGO	Ø	Esp.	Furo	Nºdentes	Vel. R.P.M.	PCS	€
MSP100	180	2,20	20	32	2500	1	63,14
MSP101	180	2,20	30	32	2500	1	63,14
MSP102	190	2,20	30	38	2200	1	77,35
MSP103	230	2,20	30	44	2200	1	73,50
MSP104	250	2,20	30	48	2200	1	94,73
MSP105	250	2,20	30	60	1600	1	106,60
MSP106	270	2,20	30	60	1600	1	123,83
MSP107	305	2,20	25,4	60	1600	1	129,77
MSP108	305	2,20	30	60	1600	1	129,77
MSP109	305	2,20	25,4	80	1600	1	134,88
MSP110	305	2,20	30	80	1200	1	134,88
MSP111	355	2,20	25,4	90	1200	1	161,67
MSP112	355	2,20	30	90	1200	1	161,67

Aplicação:

Serras circulares para corte de painéis sandwich, ferro, aço, PVC, materiais compostos, etc.

A serra com D=305 e Z=80 é recomendada para corte de aço inoxidável e corte a seco.



METAL DURO

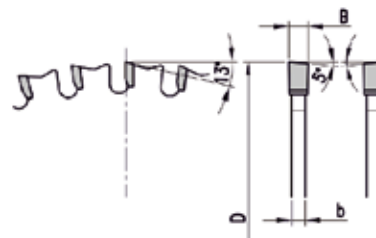

Máquinas Portáteis

CÓDIGO	Ø	Esp.	Furo	Nºdentes	PCS	€
MSP120	160	2,60	20	24	1	37,32
MSP121	160	2,40	16	48	1	53,01
MSP122	160	2,20	20	48	1	56,07
MSP123	180	2,80	30	30	1	44,83
MSP124	190	2,40	30	24	1	40,43
MSP125	190	2,40	30	40	1	65,08
MSP127	210	2,60	30	24	1	40,86
MSP128	210	2,60	30	48	1	57,58
MSP129	230	3,00	30	24	1	44,26
MSP130	230	3,00	30	34	1	51,30
MSP131	235	3,00	30	34	1	51,30
MSP132	235	3,00	30	48	1	61,95

Aplicação:

Serras circulares para corte longitudinal e transversal de madeira maciça e derivados.

Utilização para máquinas:

AEG - BLACK-DECKER - BOSH - HITACHI - KRESS - METABO - ELU - SKIL - FESTO
DEWALT - MAKITA - HAFNER - ELEKTRA - FEIN - RIOBY - PEUGEOT - HOLZ - MAFEL



METAL DURO

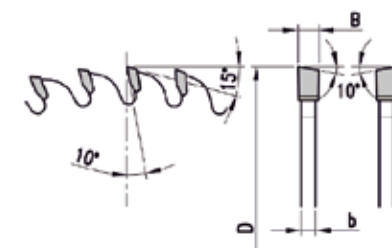

SERRAS DE FITA PARA A INDÚSTRIA ALIMENTAR EM AÇO CARBONO

CARBON STEEL BAND SAW BLADES FOR THE FOOD INDUSTRY

SCIES À RUBAN EN ACIER AU CARBONE POUR L'INDUSTRIE ALIMENTAIRE

CROMO VANADIUM



Corte de Carne

Dimensão		Nº dentes p/polegada		Preço € p/metro
Altura x Espessura		3	4	
16	x 0,50	•	•	5,83
19	x 0,50	•	•	6,79



Características:

- Aço com alta percentagem de carbono DIN 125 Cr 1 (aprox. 50 HRC).
- Execução especial do dente FOOD TOOTH - ângulo de corte neutro 0°.
- Tratamento específico da tempera localizado nos dentes (65÷66 HRC).
- Corpo da fita de serra escovado e polido.

Vantagens:

- Grande flexibilidade e resistência às torções da fita.
- Excelente rendimento e ação de corte mais fácil graças a compensação das variações de secções e densidade de carne / ossos / cartilagens de todo o tipo de carcaças de animais.
- Aumento de vida útil.
- Redução da tendência de fixação dos resíduos de material eliminado.

SERRAS DE FITA PARA A INDÚSTRIA ALIMENTAR EM INOX

M42 BIMETALLIC BAND SAW BLADES

SCIES À RUBAN EN ACIER INOXYDABLE POUR L'INDUSTRIE ALIMENTAIRE

INOX



Corte de Carne e Peixe

Dimensão		Nº dentes p/polegada		Preço € p/metro
Altura x Espessura		3	4	
16	x 0,56	•	•	11,04
19	x 0,56	•	•	12,44

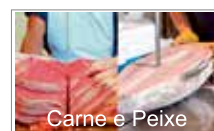

Características:

- Aço inoxidável AISI 429 B (aprox. 50 HRC).
- Execução especial do dente FOOD TOOTH - ângulo de corte neutro 0°.
- Corpo da fita de serra escovado e polido.

Vantagens:

- Nenhum fenómeno de oxidação no corpo da fita, ou seja, total ausência de transferência de contaminação e qualquer vestígio de oxidação dos alimentos cortados.
- Excelente rendimento e mais facilidade de corte de todo o tipo de carne e peixe (fresco ou congelado / com ou sem ossos).

SERRAS DE FITA BIMETÁLICA M42

M42 BIMETALLIC BAND SAW BLADES
SCIES À RUBAN BIMÉTALLIQUES M42

HSS-CO M42

PROF-MULTIUSOS M42 - PFMU

HSSE 8% CO

- Para corte de perfis, tubos, maciços e todo o tipo de materiais em geral.



Dimensão			Nº dentes p/polegada						Preço €	
Altura x Espessura			2/3	3/4	4/6	5/8	6/10	8/12		10/14
13	x	0,65					S	S	S	17,54
20	x	0,90			K	S	S	S	S	17,54
27	x	0,90			K	K	S	S	S	18,51
34	x	1,10		K	K	K	S	S	S	21,11
41	x	1,30		K	K	K				27,87

Forma do dente: (S) 0° (K) Positivo



PROF-MULTIUSOS SUPER M42 - PFSUP

HSSE 8% CO

- Para corte individuais e em série de perfis e material maciço.

- Para corte coletivo ou em camadas.



Dimensão			Nº dentes p/polegada						Preço €
Altura x Espessura			3/4	4/6	5/8	6/10	8/12	10/14	
13	x	0,65				S	S	S	19,31
20	x	0,90		S	S	S	S	S	19,31
27	x	0,90	S	S	S	S	S	S	20,05
34	x	1,10	S	S	S	S	S		22,84
41	x	1,30	S	S	S	S			30,47
54	x	1,30				S			42,29

Forma do dente: (S) 0°



PROF-PERFIL M42 - PPPER

HSSE 8% CO

- Para corte de perfis e vigas.

- Geometria do dente extra estável contra a quebra de dentes.

- Grande redução de vibrações.



Dimensão			Nº dentes p/polegada						Preço €
Altura x Espessura			2/3	3/4	4/6	5/7	8/11	12/16	
20	x	0,90				P	P	P	19,31
27	x	0,90		P	P	P	P	P	20,05
34	x	1,10	P	P	P	P	P		22,84
41	x	1,30	P	P	P	P	P		30,47
54	x	1,60	P	P	P				46,99

Forma do dente: (P) Positivo



Prestamos Assistência Técnica

SERRAS DE FITA BIMETÁLICA M42, M51 E DENTES EM METAL DURO

M42, M51 BIMETALLIC BAND SAW BLADES AND TEETH IN CARBED METAL
SCIES À RUBAN BIMÉTALLIQUES M42, M51 ET DENTS EN MÉTAL DUR

HSS-CO M42

PROF-MACIÇOS M42 - PFMA

HSSE 8% CO

- Para perfis e material maciço.
- Para corte coletivo ou em camadas.



Dimensão		Nº dentes p/polegada					Preço € p/metro
Altura x Espessura		0,75/1,25	1,4/2	2/3	3/4	4/6	
27	x 0,90		K	K	K	K	20,69
34	x 1,10		K	K	K	K	23,65
41	x 1,30		K	K	K	K	31,08
54	x 1,60		K	K	K	K	48,49
67	x 1,60	K	K	K	K	K	72,40
80	x 1,60	K	K	K			107,95

Forma do dente: (K) Positivo



PROF-INOX X-3000 M51

HSSE 10% CO

- Para perfis e material maciço.
- Para corte coletivo ou em camadas.
- Para trabalhos difíceis de maquinação.



Dimensão		Nº dentes p/polegada					Preço € p/metro
Altura x Espessura		1,4/2	2/3	3/4	4/6	5/8	
27	x 0,90			K	K	K	25,07
34	x 1,10		K	K	K		28,34
41	x 1,30		K	K	K		41,53
54	x 1,60	K	K	K	K		56,24
67	x 1,60	K	K	K	S		88,24

Forma do dente: (K) Positivo



PROF TCT/FUT

DENTES EM METAL DURO

- Para materiais abrasivos, minerais, grafite e ferro fundido cinzento.



Dimensão		Nº dentes p/polegada					Preço € p/metro
Altura x Espessura		0,85/1,15	1/1,4	1,4/2	2/3	3/4	
27	x 0,90					T	s/consulta
34	x 1,10				T	T	s/consulta
41	x 1,30			T	T	T	s/consulta
54	x 1,60	T	T	T	T		s/consulta
67	x 1,60	T	T	T	T		s/consulta
80	x 1,60	T	T	T			s/consulta

Forma do dente: (T) Positivo



Prestamos Assistência Técnica

TABELA PARA SELEÇÃO DO DENTADO

TOOTH SELECTION TABLE

TABLEAU DE SÉLECTION DES DENTS

Perfis, tubos e vigas

Até 1mm	12/16z 10/14z
1mm - 2,5mm	8/11z 8/12z
2,5mm - 5mm	5/7z 6/10z
5mm - 7mm	5/7z 5/8z
7mm - 10mm	3/4z 4/6z
10mm - 20mm	3/4z 3/4z
20mm - 45mm	2/3z 2/3z

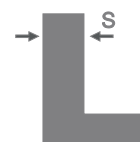
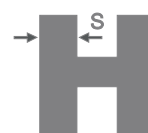
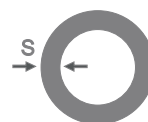

Maciços

Até 10mm	10/14z
10mm - 20mm	8/12z
20mm - 40mm	6/10z
40mm - 50mm	5/8z
50mm - 90mm	4/6z
90mm - 120mm	3/4z
120mm - 150mm	2/3z

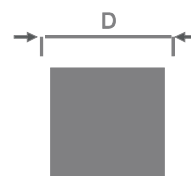
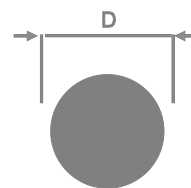

MASTER-OIL MULTIUSOS, MASTER-OIL EXTRA, MASTER-OIL CUT

MASTER-OIL MULTI USES, MASTER-OIL EXTRA, MASTER-OIL CUT
HUILES POLYVALENT, EXTRA ET COUPE

MASTER-OIL MULTIUSOS

Maquinação de uso geral

MINERAL

CÓDIGO		PCS	€
OLEO01	5 Litros	1	42,26
OLEO02	20 Litros	1	157,49
OLEO03	205 Litros	1	s/consulta



DESCRIÇÃO E APLICAÇÕES

O MASTER-OIL MULTIUSOS é um fluido de corte emulsionável para operações de maquinação geral, torneado, serrado, fresagem, etc. Em todo o tipo de materiais de aço, alumínio, latão e suas ligas, dando um alto nível de acabamento superficial.

PROPRIEDADES

As emulsões de MASTER-OIL MULTIUSOS têm uma elevada estabilidade com águas até 50° HF de dureza. Proporcionam uma boa refrigeração da zona de corte, alargando a vida das ferramentas. Tem bom poder anticorrosivo a partir de concentrações 3%, estando isento de nitratos, dando uma excelente proteção às máquinas e peças maquinadas. Contém bactericidas específicos que melhoram a resistência a fermentação das emulsões. A sua baixa tensão superficial confere-lhe boas qualidades humedificantes com o que se melhora a evacuação de calor.

MASTER-OIL EXTRA

Maquinação de uso geral Indicado para serras de fita

SEMI-SINTÉTICO

CÓDIGO		PCS	€
OLEO10	5 Litros	1	48,54
OLEO11	20 Litros	1	188,51
OLEO12	205 Litros	1	s/consulta



DESCRIÇÃO E APLICAÇÕES

O MASTER-OIL EXTRA é um fluido de corte emulsionável em água de caráter bacteriostático. Utiliza-se para operações de maquinação geral de aços e aluminios.

Indicado especialmente para serras de fita.

PROPRIEDADES

MASTER-OIL EXTRA possui uma emulsão branca opaca que proporciona uma boa refrigeração na zona de corte.

Forma uma micro-emulsão de elevada estabilidade com águas até 35° HF de dureza.

Tem bom poder anticorrosivo a partir de concentrações de 3%, estando isento de nitritos, dando uma excelente proteção às máquinas e peças maquinadas.

As emulsões de MASTER-OIL EXTRA pelo seu caráter bacteriostático, pela sua baixa concentração de uso, sua larga duração, conservação de ferramentas e aforro de bactericidas e manutenção, obtêm-se uma grande economia comparando-as com emulsões de produtos convencionais.

MASTER-OIL CUT

Maquinação de trabalhos difíceis

SEMI-SINTÉTICO

CÓDIGO		PCS	€
OLEO20	5 Litros	1	48,14
OLEO21	20 Litros	1	189,00
OLEO22	205 Litros	1	s/consulta



DESCRIÇÃO E APLICAÇÕES

O MASTER-OIL CUT é um óleo de corte especial para operações severas de maquinação de aços altamente ligados de difícil maquinação, assim como aluminios e suas ligas.

É especialmente indicado para operações de furação profunda, escariado, roscagem em aços de média e alta dureza.

PROPRIEDADES

O MASTER-OIL CUT é um produto especialmente formulado com aditivos extrema pressão e matéria gordurosa, totalmente isento de cloro, que confere excelentes condições de lubrificação durante a operação de corte, a velocidades elevadas, e em condições de trabalho severas.

O MASTER-OIL CUT mantém um perfeito equilíbrio lubri-refrigerante durante a operação de corte a altas velocidades onde se dão regimes de refrigeração limites, gerando-se pontualmente uma grande quantidade de calor.

MASTER-OIL MICRO-PULVERIZAÇÃO, CUT ALUMÍNIO E SPRAY DE CORTE

MASTER-OIL MICRO-SPRAYING, MASTER-OIL ALUMINIUM CUT AND CUTTING SPRAY
HUILES MICRO-PULVERISACION, COUPE ALUMINIUM ET HUILE DE COUPE EN SPRAY

MASTER-OIL MICRO-PULVERIZAÇÃO

Maquinação por sistema de pulverização

SINTÉTICO DE BAIXO IMPACTO AMBIENTAL

CÓDIGO	PCS	€
OLEO25	5 Litros	1 63,76
OLEO26	20 Litros	1 243,08
OLEO27	205 Litros	1 s/consulta



DESCRIÇÃO E APLICAÇÕES

O MASTER-OIL MICRO-PULVERIZAÇÃO é um óleo sintético de baixa viscosidade, isento de cloro. Está especialmente desenhado para operações de maquinação por micro-pulverização (MQL) direta na zona de contacto metal ferramenta. O produto é ideal para o corte de aço e alumínio com serras de fita e discos a altas velocidades.

PROPRIEDADES

MASTER-OIL MICRO-PULVERIZAÇÃO proporciona excelente lubrificação na zona de corte, melhorando o rendimento das ferramentas e o acabamento superficial das peças maquinadas. Na formulação são utilizadas bases e aditivos especiais que o fazem um produto biodegradável e de muito baixa toxicidade. Não contendo cloro, metais pesados, silicões e outras substâncias que possam afetar as pessoas e o meio ambiente.

MASTER-OIL CUT ALUMÍNIO

Polimento ou retificação de qualquer tipo de metais

INDICADO PARA ALUMÍNIO

CÓDIGO	PCS	€
OLEO35	5 Litros	1 47,92
OLEO36	20 Litros	1 173,54



DESCRIÇÃO E APLICAÇÕES

O MASTER-OIL CUT ALUMÍNIO é um óleo formulado para polimento ou rectificação de qualquer tipo de metais, por meio de mós de diamante ou abrasivos. Especialmente indicado para alumínio. A incorporação de gordura na fórmula permite um polimento perfeito sem riscar o metal.

PROPRIEDADES

MASTER-OIL CUT ALUMÍNIO é constituído essencialmente por misturas de óleos minerais altamente refinados e solventes, humectantes e antioxidantes com aditivos. O óleo mineral utilizado é na sua natureza altamente parafínico e refinado, de modo que os problemas na pele dos trabalhadores são evitados. A baixa viscosidade, juntamente com o seu detergente de alta potencia, permite o uso em afiação e polimento em operações sem embotamento dos dentes, fitas, lixas, etc. É um óleo devido à incorporação de surfactantes muito energéticos, tem a propriedade de ser lavável com água, tornando-se assim num produto muito adequado para polimento de perfis de alumínio, obtendo por essa razão um desengordurante de volta perfeita.

Expositor
Óleo Spray

Composição
6 sprays

CÓDIGO	€
OLEO51	69,42



Expositor
Óleo Spray

Composição
12 sprays

CÓDIGO	€
OLEO52	138,84



MASTER-OIL Spray Óleo de Corte

CÓDIGO	€
OLEO50	400 ml 11,57



É ideal para roscar, furar, fresar e escarear. Prolonga a vida da ferramenta, otimiza a saída da limalha e melhora o rendimento de corte e a qualidade superficial do acabamento

CONSTRUCTION



CONSTRUÇÃO



BROCAS PARA MARTELOS SDS/PLUS "S4" SUPER PROFISSIONAL

SDS PLUS ROTARY HAMMER DRILLS
FORETS PERCUSSION SDS-PLUS "S4"

Made in Germany

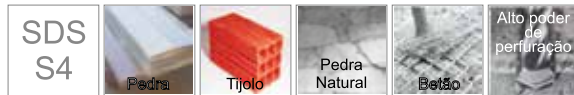

CÓDIGO	Ø	l mm	L mm	PCS	€
MTSDS001	4,00	50	110	1	3,23
MTSDS002	5,00	50	110	1	2,86
MTSDS003	5,00	100	160	1	3,31
MTSDS004	5,00	150	210	1	4,34
MTSDS005	5,00	250	310	1	7,57
MTSDS006	5,50	50	110	1	3,17
MTSDS007	5,50	100	160	1	3,51
MTSDS093	5,50	150	210	1	4,69
MTSDS008	6,00	50	110	1	2,91
MTSDS009	6,00	100	160	1	3,11
MTSDS010	6,00	150	210	1	4,34
MTSDS011	6,00	200	260	1	5,20
MTSDS012	6,00	400	460	1	12,09
MTSDS013	6,50	50	110	1	3,26
MTSDS014	6,50	100	160	1	4,14
MTSDS015	6,50	150	210	1	4,83
MTSDS016	7,00	50	110	1	3,34
MTSDS017	7,00	100	160	1	4,17
MTSDS018	7,00	150	210	1	5,03
MTSDS019	8,00	50	110	1	3,23
MTSDS020	8,00	100	160	1	3,51
MTSDS021	8,00	150	210	1	4,46
MTSDS022	8,00	200	260	1	5,57
MTSDS023	8,00	250	310	1	7,46
MTSDS025	8,00	400	460	1	9,51
MTSDS026	8,00	550	600	1	15,83
MTSDS027	9,00	100	160	1	4,14
MTSDS028	9,00	150	210	1	5,49
MTSDS029	10,00	50	110	1	3,57
MTSDS030	10,00	100	160	1	4,03
MTSDS031	10,00	150	210	1	5,09
MTSDS032	10,00	200	260	1	6,11
MTSDS033	10,00	250	310	1	7,66
MTSDS034	10,00	400	450	1	13,06
MTSDS035	10,00	550	600	1	14,51
MTSDS036	10,00	950	1000	1	28,37
MTSDS037	11,00	100	160	1	5,03
MTSDS039	11,00	200	260	1	6,46
MTSDS040	12,00	100	160	1	5,29
MTSDS041	12,00	150	210	1	5,97
MTSDS042	12,00	200	260	1	7,51
MTSDS043	12,00	250	310	1	9,60
MTSDS044	12,00	400	450	1	12,11
MTSDS045	12,00	550	600	1	15,71
MTSDS046	12,00	950	1000	1	42,97

CÓDIGO	Ø	l mm	L mm	PCS	€
MTSDS047	13,00	100	160	1	6,60
MTSDS048	13,00	150	210	1	8,17
MTSDS049	13,00	200	260	1	8,97
MTSDS050	14,00	100	160	1	6,31
MTSDS051	14,00	150	210	1	7,86
MTSDS052	14,00	200	260	1	8,86
MTSDS053	14,00	250	310	1	10,54
MTSDS054	14,00	400	450	1	13,06
MTSDS055	14,00	550	600	1	19,40
MTSDS056	14,00	950	1000	1	44,71
MTSDS057	15,00	100	160	1	8,63
MTSDS058	15,00	200	260	1	10,00
MTSDS094	16,00	110	160	1	7,96
MTSDS060	16,00	150	210	1	8,63
MTSDS061	16,00	200	260	1	11,97
MTSDS062	16,00	250	310	1	13,06
MTSDS063	16,00	400	450	1	15,51
MTSDS064	16,00	550	600	1	20,31
MTSDS066	16,00	950	1000	1	48,54
MTSDS067	18,00	150	200	1	14,37
MTSDS069	18,00	250	300	1	17,17
MTSDS070	18,00	400	450	1	21,11
MTSDS071	18,00	550	600	1	30,14
MTSDS072	18,00	950	1000	1	59,17
MTSDS073	19,00	150	200	1	18,31
MTSDS074	20,00	150	200	1	19,74
MTSDS075	20,00	250	300	1	22,46
MTSDS076	20,00	400	450	1	24,71
MTSDS077	20,00	550	600	1	32,60
MTSDS078	20,00	950	1000	1	63,40
MTSDS079	22,00	200	250	1	23,60
MTSDS081	22,00	400	450	1	34,60
MTSDS082	22,00	550	600	1	48,54
MTSDS083	22,00	950	1000	1	71,37
MTSDS084	24,00	200	250	1	31,63
MTSDS085	24,00	400	450	1	41,06
MTSDS086	25,00	200	250	1	31,03
MTSDS087	25,00	400	450	1	37,66
MTSDS088	25,00	950	1000	1	92,34
MTSDS089	26,00	200	250	1	33,46
MTSDS090	26,00	400	450	1	43,80

Linha para Expositor

Composição 90 brocas

UN	MEDIDA
10	5 × 110
10	5 × 160
10	6 × 110
10	6 × 160
10	8 × 160
10	8 × 210
10	10 × 160
10	10 × 210
10	12 × 210



Jogo de Brocas em Caixa Plástica

Composição 7 brocas

Ø	UN
5,00 × 110	1
6,00 × 110	1
8,00 × 110	1
6,00 × 160	1
8,00 × 160	1
10,00 × 160	1
12,00 × 160	1

CÓDIGO

€

MTSDS301 26,06€

BROCAS PARA MARTELOS SDS/PLUS "4X4" SUPER PROFISSIONAL

4 CUTTERS SDS/PLUS ROTARY HAMMER DRILLS
FORETS PERCUSSION SDS-PLUS 4X4

Made in Germany



CÓDIGO	Ø	l mm	L mm	PCS	€
MT4X4001	5,00	50	110	1	5,08
MT4X4002	5,00	100	160	1	5,45
MT4X4003	5,50	50	110	1	5,40
MT4X4004	5,50	100	160	1	5,85
MT4X4005	6,00	50	110	1	5,06
MT4X4006	6,00	100	160	1	5,13
MT4X4007	6,00	150	210	1	7,03
MT4X4008	6,00	200	260	1	8,45
MT4X4009	6,00	250	310	1	12,08
MT4X4010	6,50	100	160	1	7,15
MT4X4011	6,50	150	210	1	9,63
MT4X4012	6,50	200	260	1	12,91
MT4X4013	6,50	250	310	1	15,01
MT4X4014	7,00	50	110	1	6,79
MT4X4015	7,00	100	160	1	7,16
MT4X4016	8,00	50	110	1	5,99
MT4X4017	8,00	100	160	1	6,31
MT4X4018	8,00	150	210	1	7,16
MT4X4019	8,00	200	260	1	9,20
MT4X4020	8,00	250	310	1	12,99
MT4X4021	8,00	400	460	1	19,35
MT4X4022	10,00	50	110	1	7,16
MT4X4023	10,00	100	160	1	7,66
MT4X4024	10,00	150	210	1	9,02
MT4X4025	10,00	200	260	1	10,97
MT4X4026	10,00	250	310	1	13,27
MT4X4027	10,00	400	450	1	23,13
MT4X4028	10,00	950	1000	1	83,87
MT4X4029	12,00	100	160	1	8,84
MT4X4030	12,00	150	210	1	10,75
MT4X4031	12,00	200	260	1	12,24

CÓDIGO	Ø	l mm	L mm	PCS	€
MT4X4032	12,00	250	310	1	16,78
MT4X4033	12,00	400	450	1	24,21
MT4X4034	12,00	950	1000	1	88,55
MT4X4035	14,00	100	160	1	12,01
MT4X4036	14,00	150	210	1	16,04
MT4X4037	14,00	200	260	1	18,41
MT4X4038	14,00	250	310	1	20,70
MT4X4039	14,00	400	450	1	25,99
MT4X4040	14,00	950	1000	1	91,88
MT4X4041	16,00	100	160	1	20,70
MT4X4042	16,00	150	210	1	23,31
MT4X4043	16,00	200	260	1	24,78
MT4X4044	16,00	250	310	1	27,95
MT4X4045	16,00	400	450	1	33,18
MT4X4046	16,00	950	1000	1	96,94
MT4X4047	18,00	200	250	1	33,99
MT4X4048	18,00	400	450	1	40,12
MT4X4049	20,00	200	250	1	40,19
MT4X4050	20,00	400	450	1	46,22
MT4X4051	22,00	200	250	1	42,58
MT4X4052	22,00	400	450	1	53,64
MT4X4053	24,00	200	250	1	58,22
MT4X4054	24,00	400	450	1	59,32
MT4X4055	25,00	200	250	1	50,97
MT4X4056	25,00	400	450	1	62,47
MT4X4057	28,00	200	250	1	60,07
MT4X4058	28,00	400	450	1	66,03
MT4X4059	30,00	200	250	1	63,32
MT4X4060	30,00	400	450	1	86,38
MT4X4061	32,00	400	450	1	92,99



Jogo de Brocas em Caixa Plástica

Composição 7 brocas

Ø	UN
5,00 × 110	1
6,00 × 110	1
8,00 × 110	1
6,00 × 160	1
8,00 × 160	1
10,00 × 160	1
12,00 × 160	1

CÓDIGO	€
MT4X4400	39,83€



Linha para Expositor

Composição 80 brocas

UN	MEDIDA
10	5 × 110
10	5 × 160
10	6 × 110
10	6 × 160
10	8 × 160
10	8 × 210
5	10 × 160
5	10 × 210
5	12 × 210

CÓDIGO	€
--------	---

BROCAS PARA MARTELOS SDS MAX - 4 CORTES (PREMIUM)

4 CUTTERS SDS MAX ROTARY HAMMER DRILLS (PREMIUM)

FORETS PERCUSSION SDS-MAX 4 POINTES (PREMIUM)

Made in Germany



4 CORTES



CÓDIGO	Ø	l mm	L mm	PCS	€
MBMA001	12,00	200	340	1	39,85
MBMA002	12,00	400	540	1	46,74
MBMA003	12,00	600	740	1	73,12
MBMA004	14,00	200	340	1	40,98
MBMA005	14,00	400	540	1	52,49
MBMA006	16,00	200	340	1	49,23
MBMA007	16,00	400	540	1	51,14
MBMA008	18,00	200	340	1	44,95
MBMA009	18,00	400	540	1	55,23
MBMA010	18,00	800	940	1	71,48
MBMA011	20,00	200	320	1	46,49
MBMA012	20,00	400	520	1	54,92
MBMA013	20,00	800	920	1	80,83
MBMA014	20,00	1200	1320	1	163,42
MBMA015	22,00	200	320	1	52,95
MBMA016	22,00	400	520	1	60,28
MBMA017	22,00	800	920	1	88,80
MBMA018	22,00	1200	1320	1	196,77
MBMA019	24,00	200	320	1	57,88
MBMA020	24,00	400	520	1	69,72
MBMA021	25,00	200	320	1	53,35
MBMA022	25,00	400	520	1	61,29
MBMA023	25,00	800	920	1	100,28
MBMA024	25,00	1200	1320	1	178,32
MBMA025	26,00	400	520	1	78,43
MBMA026	28,00	250	370	1	71,77
MBMA027	28,00	450	570	1	81,37
MBMA028	30,00	250	370	1	76,07
MBMA029	30,00	450	570	1	87,47
MBMA030	32,00	250	370	1	78,60
MBMA031	32,00	450	570	1	93,87
MBMA032	32,00	800	920	1	143,97
MBMA033	32,00	1200	1320	1	202,00
MBMA038	35,00	450	570	1	110,73
MBMA034	38,00	250	370	1	116,33
MBMA035	38,00	450	570	1	128,50
MBMA036	40,00	450	570	1	151,27
MBMA037	40,00	800	920	1	185,82
MBMA039	40,00	1200	1320	1	307,86



Brocas para Martelos SDS MAX - 4 Cortes

Composição 20 brocas

CÓDIGO	Medida	PCS	€
MBMA001	12 × 340	2	39,85
MBMA004	14 × 340	2	40,98
MBMA006	16 × 340	2	49,23
MBMA008	18 × 340	2	44,95
MBMA009	18 × 540	2	55,23
MBMA011	20 × 320	2	46,49
MBMA012	20 × 520	2	54,92
MBMA015	22 × 320	2	52,95
MBMA016	22 × 520	2	60,28
MBMA022	25 × 520	2	61,29

CÓDIGO	€
MLMAX50	1134,33

Outras medidas sob consulta

BROCAS CILÍNDRICAS PARA PEDRA "STANDARD" (QUALIDADE EXTRA)

STANDARD MASONRY CARBIDE TIPPED DRILLS (HIGH QUALITY)

FORETS POINTE CARBURE MAÇONNERIE "STANDARD" (QUALITÉ SUPPLÉMENTAIRE)



CÓDIGO	Ø	l mm	L mm	PCS	€
MNBP100	3,00	30	60	1	0,47
MNBP122	3,50	35	60	1	0,48
MNBP101	4,00	40	75	1	0,51
MNBP121	4,50	40	75	1	0,54
MNBP102	5,00	40	85	1	0,63
MNBP103	5,50	45	85	1	0,70
MNBP104	6,00	65	120	1	0,63
MNBP105	6,50	55	100	1	0,79
MNBP106	7,00	55	100	1	0,77
MNBP123	7,50	70	120	1	0,90
MNBP107	8,00	70	120	1	0,92
MNBP108	9,00	70	120	1	1,27
MNBP109	10,00	70	120	1	1,60
MNBP110	11,00	90	150	1	2,23
MNBP111	12,00	90	150	1	2,12
MNBP112	13,00	90	150	1	2,64
MNBP113	14,00	90	150	1	2,63
MNBP115	16,00	90	150	1	2,85
MNBP116	18,00	100	160	1	4,97
MNBP117	19,00	100	160	1	5,27
MNBP118	20,00	100	160	1	5,27
MNBP119	22,00	100	160	1	6,97
MNBP120	25,00	100	160	1	8,36



Jogo de Brocas em Caixa Plástica

Composição 8 brocas

Ø	UN
3,00	1
4,00	1
5,00	1
6,00	1
7,00	1
8,00	1
9,00	1
10,00	1

CÓDIGO €

MNBE02 12,99€



Longas Comprimento de 300mm e 400mm

CÓDIGO	Ø	l mm	L mm	PCS	€
MNBPL50	6,00 × 300	230	300	1	2,05
MNBPL52	8,00 × 300	210	300	1	3,07
MNBPL53	10,00 × 300	210	300	1	3,93
MNBPL54	12,00 × 300	210	300	1	5,30
MNBPL55	14,00 × 300	210	300	1	6,24
MNBPL56	16,00 × 300	210	300	1	7,10
MNBPL57	18,00 × 300	210	300	1	7,19
MNBPL58	20,00 × 300	210	300	1	8,14
MNBPL59	22,00 × 300	210	300	1	9,09
MNBPL60	25,00 × 300	210	300	1	11,31
MNBPL70	8,00 × 400	300	400	1	5,04
MNBPL71	10,00 × 400	300	400	1	6,75
MNBPL72	12,00 × 400	300	400	1	6,96
MNBPL73	14,00 × 400	300	400	1	7,37
MNBPL74	16,00 × 400	300	400	1	8,26
MNBPL75	18,00 × 400	300	400	1	9,52
MNBPL76	20,00 × 400	300	400	1	10,48
MNBPL77	22,00 × 400	300	400	1	11,43
MNBPL78	25,00 × 400	300	400	1	12,86

BROCAS UNIVERSAIS "FURA TUDO"

UNIVERSAL "MULTI-PURPOSE" DRILLS
FORETS UNIVERSELS "POLYVALENTE"



CÓDIGO	Ø	l mm	L mm	PCS	€
MTFT01*	3,00	40	70	1	2,37
MTFT02*	4,00	40	75	1	2,37
MTFT03*	5,00	40	85	1	2,37
MTFT04*	6,00	55	100	1	2,47
MTFT05*	7,00	55	100	1	2,81
MTFT06*	8,00	70	120	1	3,00
MTFT07*	9,00	70	120	1	3,54
MTFT08*	10,00	70	120	1	3,76
MTFT09*	11,00	90	150	1	5,14
MTFT10*	12,00	90	150	1	5,14
MTFT11*	13,00	90	150	1	7,41
MTFT12*	14,00	90	150	1	8,79
MTFT13*	15,00	90	150	1	11,57
MTFT14*	16,00	90	150	1	11,57

*Até fim de existência



Jogo de Brocas em Caixa Plástica	
Composição 8 brocas	
Ø	UN
3,00	1
4,00	1
5,00	1
6,00	1
8,00	1
9,00	1
10,00	1
12,00	1
CÓDIGO	€
MTBE03*	25,05€

Jogo de Brocas em Caixa Plástica	
Composição 4 brocas	
Ø	UN
5,00	1
6,00	1
8,00	1
10,00	1
CÓDIGO	€
MTBE04*	11,61€

*Até fim de existência

BROCAS UNIVERSAIS "FURA TUDO" DE ALTO RENDIMENTO MULTIFUNÇÕES

HIGH PERFORMANCE UNIVERSAL "MULTI-PURPOSE" DRILLS
FORETS UNIVERSELS "POLYVALENTE" - HAUTE PERFORMANCE

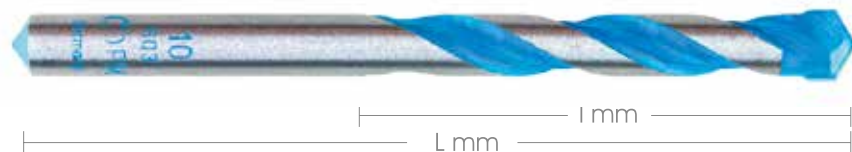

CÓDIGO	Ø	l mm	L mm	PCS	€
MTFT20	3,00	40	70	1	4,44
MTFT21	4,00	40	75	1	4,44
MTFT22	5,00	50	85	1	4,67
MTFT23	5,00	90	150	1	6,73
MTFT24	5,50	50	85	1	5,15
MTFT25	6,00	60	100	1	5,23
MTFT26	6,00	90	150	1	7,36
MTFT27	6,50	60	100	1	5,71
MTFT28	7,00	60	100	1	6,50
MTFT29	8,00	80	120	1	6,73
MTFT30	8,00	90	150	1	8,32
MTFT31	8,00	200	250	1	9,59
MTFT32	8,00	350	400	1	35,25

CÓDIGO	Ø	l mm	L mm	PCS	€
MTFT33	9,00	80	120	1	6,90
MTFT34	10,00	80	120	1	7,12
MTFT35	10,00	90	150	1	9,34
MTFT36	10,00	200	250	1	12,44
MTFT38	11,00	90	150	1	10,70
MTFT39	12,00	90	150	1	16,15
MTFT40	12,00	200	250	1	13,70
MTFT41	12,00	350	400	1	38,20
MTFT42	14,00	150	200	1	14,65
MTFT43	14,00	200	250	1	15,05
MTFT44	16,00	150	200	1	24,55



Características:

- Plakete em metal duro, afiada e retificada com geometria inovadora.
- A cabeça da Plakete garante uma centragem perfeita.
- Corpo da ferramenta em liga de aço.
- Hélice inovadora com ângulo acentuado.

Linha para Expositor	
Composição 70 brocas	
UN	MEDIDA
5	3 × 70
5	4 × 75
5	5 × 85
5	10 × 120
5	10 × 150
5	12 × 150
10	6 × 100
10	8 × 120
8	6 × 150
8	8 × 150
2	14 × 200
2	16 × 200
CÓDIGO	€
MLFT50	572,65€



Jogo de Brocas Fura Tudo	
Composição 4 Peças	
Ø	UN
4,00	1
5,00	1
6,00	1
8,00	1
CÓDIGO	€
MTFT97	20,38€



Jogo de Brocas Fura Tudo	
Composição 7 Peças	
Ø	UN
3,00	1
4,00	1
5,00	1
6,00	1
8,00	1
9,00	1
10,00	1
CÓDIGO	€
MTFT99	38,73€

BROCAS UNIVERSAIS" FURA TUDO" ALTO RENDIMENTO CABO HEX 1/4

HIGH PERFORMANCE UNIVERSAL "MULTI-PURPOSE" DRILLS WITH HEXAGONAL HANDLE
FORETS UNIVERSELS "POLYVALENTE" POIGNÉE HEXAGONALE- HAUTE PERFORMANCE

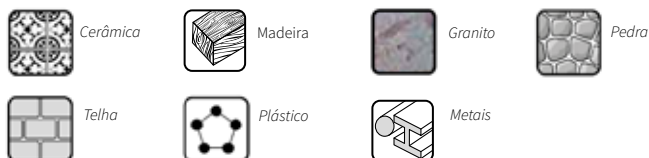
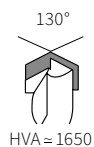

CÓDIGO	Ø	Polegadas	d	l	L	PCS	€
MBE200	3	1/8	1/4	45	90	1	6,88
MBE201	4	5/32	1/4	45	90	1	6,92
MBE202	5	3/16	1/4	50	100	1	7,08
MBE203	5,5	7/32	1/4	60	100	1	7,60
MBE204	6	15/64	1/4	60	100	1	7,80
MBE205	6	15/64	1/4	200	250	1	14,12
MBE206	6,5	1/4	1/4	200	250	1	14,81
MBE207	7	9/32	1/4	50	100	1	9,56
MBE208	8	5/16	1/4	50	100	1	9,39
MBE209	10	3/8	1/4	90	150	1	13,72

Set Brocas Fura Tudo	
Composição 4 peças	
1 x Ø 4 mm	
2 x Ø 5 mm	
1 x Ø 8 mm	
CÓDIGO	€
MBE210	31,88

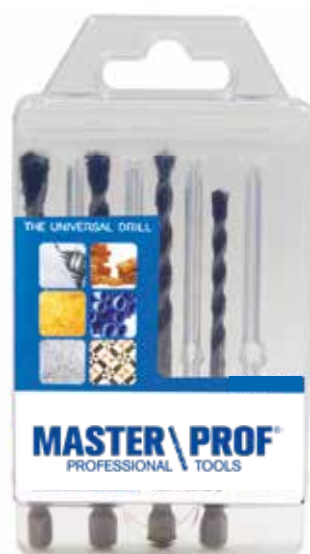

BROCA ESPECIAL PARA GRÉS PORCELÂNICO GRESMASTER

SPECIAL DRILL FOR PORCELAIN STONEWARE

FORET SPÉCIAL POUR GRÈS CÉRAME

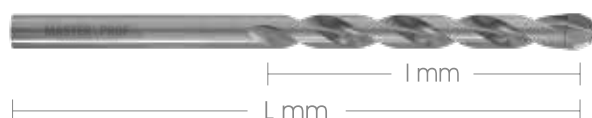

CÓDIGO	Ø	l	L	€
MBG01	4	50	85	12,30
MBG02	5	50	85	13,26
MBG03	6	65	100	13,94
MBG04	8	75	125	17,48
MBG05	10	90	150	20,68



Diâmetro da Broca 4÷6 8÷10

RPM 500 400

Jogo de Brocas GRESMASTER

Composição 3 peças

Ø	UN
1	6
1	8
1	10

CÓDIGO €

MBG10 56,60€

É a ferramenta mais fácil e intuitiva de usar.. é usada a seco, é auto-centrante.

GRESMASTER

Broca para grés porcelânico

Para prolongar a sua vida útil, a broca deve ser usada para furar apenas o azulejo (1); ao entrar em contacto com a parede, se for necessário, deve-se instalar buchas de fixação (3); é aconselhável continuar o furo com uma broca de percussão rotativa normal para concreto (2).

A única precaução fundamental é **usar uma baixa rotação**, aproximadamente a 500 r.p.m..



A broca deve ser utilizada exclusivamente em **rotação**, sem o uso de percussão e tendo o cuidado de arrefecer entre os furos.

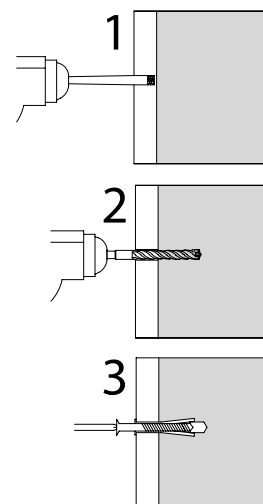

BROCAS "MASTER GRANITO" PARA FURAR GRANITO

"MASTER GRANITE" DRILLS
FORETS POUR PERCER LE GRANIT



CÓDIGO	Ø	d	l mm	L mm	PCS	€
MTG001	3,00	2,80	30	60	1	1,12
MTG002	4,00	3,80	40	75	1	1,36
MTG003	5,00	4,50	50	75	1	1,70
MTG004	6,00	5,50	60	100	1	2,41
MTG005	7,00	6,50	60	100	1	2,99
MTG006	8,00	7,50	80	120	1	3,52
MTG007	9,00	8,00	80	120	1	4,29
MTG008	10,00	9,00	80	120	1	4,87
MTG009	11,00	10,00	90	150	1	5,87
MTG010	12,00	10,00	90	150	1	6,59
MTG011	13,00	10,00	90	150	1	8,22
MTG012	14,00	10,00	90	150	1	8,46
MTG013	15,00	10,00	100	160	1	9,39
MTG014	16,00	10,00	100	160	1	10,80
MTG015	18,00	10,00	100	160	1	13,20
MTG016	20,00	13,00	100	160	1	17,84

Prazo de entrega sujeito a confirmação

CÓDIGO	Ø	d	l mm	L mm	PCS	€
MTG200	8,00	7,50	200	250	1	19,11
MTG201	10,00	9,00	200	250	1	21,17
MTG202	12,00	10,00	200	250	1	26,71
MTG203	14,00	10,00	200	250	1	32,42

Prazo de entrega sujeito a confirmação



Jogo de Brocas em Caixa Plástica	
Composição 7 brocas	
Ø	UN
3,00	1
4,00	1
5,00	1
6,00	1
8,00	1
9,00	1
10,00	1
CÓDIGO	€
MTG301	39,27€

BROCAS "EXTREME" ESPECIAL PARA MATERIAIS DUROS COM PONTA METAL DURO

"EXTREME" SPECIAL DRILLS FOR HARD MATERIALS

FORETS "EXTREME" POUR MATÉRIAUX DURS



CÓDIGO	Ø	d	l mm	L mm	PCS	€
MTE001	3,00	2,80	30	70	1	3,24
MTE002	4,00	3,80	40	75	1	3,51
MTE003	5,00	4,50	50	85	1	3,51
MTE004	6,00	5,50	60	100	1	3,57
MTE005	7,00	6,50	60	100	1	6,06
MTE006	8,00	7,50	80	120	1	4,42
MTE007	10,00	9,00	80	120	1	6,21
MTE008	12,00	10,00	90	150	1	9,61
MTE009	14,00	10,00	200	250	1	14,18



Jogo de Brocas em Caixa Plástica	
Composição 4 brocas	
Ø	UN
5,00	1
6,00	1
8,00	1
10,00	1
CÓDIGO	€
MTE050	19,87

Corte preciso e com rotação rápida em materiais duros e abrasivos.

Venda até ao fim de existência

BROCAS PARA VIDRO COM PONTA EM METAL DURO

"EXTREME" SPECIAL DRILLS FOR HARD MATERIALS

FORETS "EXTREME" POUR MATÉRIAUX DURS



CÓDIGO	Ø	d	L mm	PCS	€
MTV001	3,00	3,00	58	1	4,82
MTV002	4,00	3,00	58	1	4,82
MTV003	5,00	4,00	58	1	5,22
MTV004	6,00	5,00	58	1	5,22
MTV005	7,00	5,00	78	1	5,40
MTV006	8,00	6,00	78	1	5,40
MTV007	9,00	6,00	98	1	5,80
MTV008	10,00	7,00	98	1	5,80
MTV009	12,00	8,00	98	1	7,00

BROCAS DIAMANTADAS PARA GRÊS PORCELÂNICO E MATERIAIS DUROS

DIAMOND DRILLS AND CORE DRILLS FOR SANDWARE, SANDSTONE AND VERY HARD MATERIALS
FORETS DIAMANTÉES AVEC COURONNE CONTINUE POUR GRÊS ET MATÉRIAUX DURS



CÓDIGO	Ø	d	L mm	PCS	€
MKB01	5,00	9,50	56	1	20,85
MKB02	6,00	9,50	56	1	20,85
MKB03	7,00	9,50	56	1	20,85
MKB04	8,00	9,50	56	1	20,85
MKB05	10,00	9,50	56	1	23,03
MKB06	12,00	9,50	56	1	26,99
MKB07	14,00	9,50	56	1	36,95

CÓDIGO	Ø	d	L mm	PCS	€
MKB08	16,00	12,50	90	1	50,28
MKB09	18,00	12,50	90	1	50,28
MKB10	20,00	12,50	90	1	54,66
MKB11	22,00	12,50	90	1	60,13
MKB12	25,00	12,50	90	1	67,23
MKB13	28,00	12,50	90	1	74,32
MKB14	30,00	12,50	90	1	79,80
MKB15	32,00	12,50	90	1	81,98
MKB17	40,00	12,50	90	1	108,21
MKB19	50,00	12,50	90	1	133,36
MKB20	60,00	12,50	90	1	157,41
MKB21	65,00	12,50	90	1	169,44
MKB23	67,00	12,50	90	1	177,18
MKB24	70,00	12,50	90	1	187,90
MKB22	80,00	12,50	90	1	206,60



Diametro da fresa em mm	5 a 7	8 a 10	12 a 14	16 a 25	28 a 35	40 a 50	60 a 80
Velocidade R. P. M.	1000	800	500	400	260	170	120

Exemplo de utilização da broca



Broca Guia Ponta Metal Duro Ø6X100MM
Compatível MKB08 a MKB22



CÓDIGO	€
MKB25	4,94



Jogo de Brocas em Caixa Plástica	
Composição 5 brocas	
Ø	UN
5,00	1
6,00	1
8,00	1
10,00	1
12,00	1
CÓDIGO	€
MKB50	115,80



Vitrine
Composição 13 brocas
1 peça de cada Ø 6, 8, 10, 12, 14, 16, 18, 20, 25, 30, 35, 40, 50
OFERTA VITRINE

BROCAS DIAMANTADAS PARA GRÊS PORCELÂNICO COM ROSCA M14

DIAMOND DRILLS AND CORE DRILLS FOR SANDWARE, SANDSTONE WITH M14 THREAD
FORETS DIAMANTÉES AVEC COURONNE CONTINUE POUR GRÊS

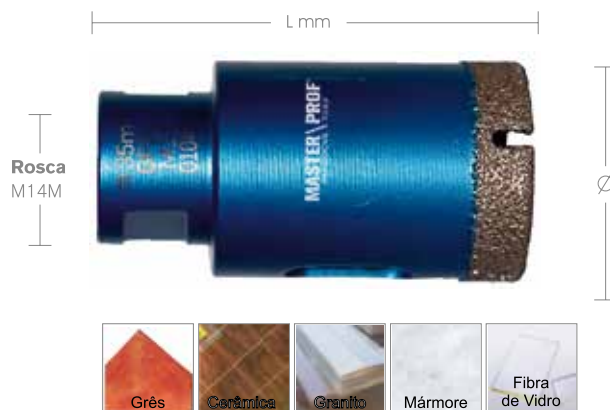

CÓDIGO	Ø	l mm	Rosca	PCS	€
MDG01	6	65	M14M	1	24,49
MDG02	8	65	M14M	1	27,11
MDG03	10	65	M14M	1	28,86
MDG04	12	65	M14M	1	30,62
MDG05	14	65	M14M	1	32,36
MDG06	18	90	M14M	1	38,35
MDG07	20	65	M14M	1	38,49
MDG08	25	90	M14M	1	39,50
MDG09	27	65	M14M	1	40,23
MDG10	30	65	M14M	1	41,98
MDG11	32	90	M14M	1	42,50
MDG12	35	65	M14M	1	45,48
MDG13	40	65	M14M	1	52,48
MDG14	45	65	M14M	1	53,35
MDG15	50	65	M14M	1	60,35
MDG16	55	90	M14M	1	61,20
MDG17	60	65	M14M	1	64,73
MDG18	65	65	M14M	1	69,10
MDG19	68	90	M14M	1	70,00
MDG20	70	65	M14M	1	72,60
MDG21	75	65	M14M	1	74,34
MDG22	82	90	M14M	1	106,00
MDG23	85	65	M14M	1	109,09
MDG24	100	65	M14M	1	124,53
MDG25	110	90	M14M	1	137,50

Expositor	
Composição	
Ø	UN
6,00	5
8,00	5
10,00	3
12,00	3
20,00	2
35,00	2
40,00	2
Adaptador B1	5
Adaptador W1	5

CÓDIGO	€
--------	---



Adaptador

CÓDIGO	Tipo	Cabo	Rosca	🔧	PCS	€
MDG30	B1	Ø 12mm	M14M	19	1	17,47
MDG31	W1	SDS+	M14M	19	1	50,40

Características:

- Iniciar a furação com a broca inclinada e prosseguir com movimentos leves oscilantes;
- Arrefecer durante a perfuração;
- No final de vida, a altura da coroa não muda.

VENTOSAS E ACESSÓRIOS

SUCTION CUPS AND ACCESSORIES
VENTOUSES ET ACCESSOIRES



VENTOSA DE PERFURAÇÃO

7 BURACOS Ø

4 - 5 - 6 - 7
8 - 10 - 12 mm

CÓDIGO

€

MVG200

33,57



VENTOSA GUIA REGULÁVEL

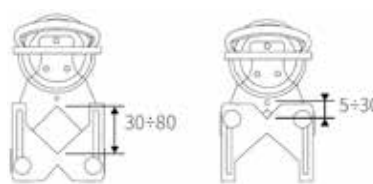

CÓDIGO

€

MVG201

37,59



**PASTA GEL PARA REFRIGERAÇÃO
250 ML**

CÓDIGO

€

MDG90

13,33



GARRAFA DE REFRIGERAÇÃO 1L

CÓDIGO

€

MVG202

16,52

COROA SEGMENTADA PROFISSIONAL PARA BETÃO - CORTE A HÚMIDO

DIAMOND CORE DRILLS WET CUTTING FOR DRILLING MACHINES

FORETS DIAMANTES COUPE A EAU POUR CAROTEUSES

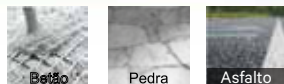
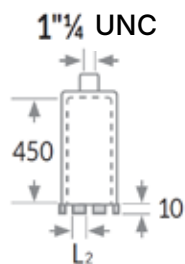

BETÃO - CIMENTO FRESCO - ASFALTO - PEDRA ABRASIVA

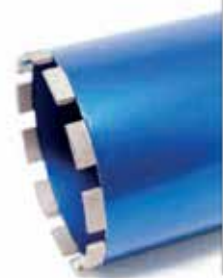

CÓDIGO	Ø	Espessura	Dentes	L2	€
MDC001	32	3,2	3	17	95,51
MDC002	37	3,2	4	17	109,42
MDC003	42	3,2	5	17	119,14
MDC004	47	3,2	5	17	121,11
MDC005	52	3,2	6	17	133,91
MDC006	57	3,2	5	24	135,88
MDC007	62	3,2	5	24	138,83
MDC008	67	3,2	5	24	141,78
MDC009	72	3,2	6	24	153,60
MDC010	82	3,2	7	24	169,35
MDC011	92	3,2	8	24	188,06
MDC012	102	3,4	9	24	210,71
MDC013	107	3,4	9	24	217,60
MDC014	112	3,4	9	24	224,49

CÓDIGO	Ø	Espessura	Dentes	L2	€
MDC015	122	3,4	9	24	232,37
MDC016	127	3,4	10	24	246,15
MDC017	132	3,6	10	24	253,05
MDC018	142	3,6	11	24	270,77
MDC019	152	3,6	12	24	289,48
MDC020	162	3,6	12	24	320,98
MDC021	182	3,6	13	24	360,37
MDC022	201	4	14	24	416,49
MDC023	231	4	15	24	488,37
MDC024	251	4	16	24	512,00
MDC025	300	4,4	18	24	615,38
MDC026	350	4,4	19	24	726,65
MDC027	400	4,4	21	24	842,83
MDC028	500	4,4	23	24	970,83

*Colocação e Reparação de Segmentos sob consulta

Rpm	Diâmetro da Coroa																						
	6	8	10	14	18	22	32	42	52	62	72	82	102	122	142	162	182	202	252	302	352	402	502
vpf m/sec	3 200	2 400	1 950	1 400	1 100	870	600	455	370	310	270	235	190	160	135	120	105	95	76	64	55	48	39
1	4 800	3 600	2 900	2 050	1 600	1 350	900	685	555	465	400	350	285	235	205	180	160	145	115	95	82	72	58
1,5	6 400	4 800	3 850	2 750	2 150	1 750	1 200	910	735	620	535	470	375	315	270	240	210	190	155	130	110	100	80
2	8 000	6 000	4 800	3 450	2 700	2 200	1 500	1 150	920	775	665	585	470	395	340	295	265	240	190	160	140	120	100
2,5	9 550	7 200	5 750	4 100	3 200	2 650	1 800	1 400	1 150	925	800	700	565	470	405	355	315	285	230	190	165	145	115
3	11 150	8 400	6 700	4 800	3 750	3 050	2 100	1 600	1 300	1 100	930	820	660	550	475	415	370	335	270	225	190	170	135
3,5	12 750	9 550	7 650	5 500	4 250	3 500	2 400	1 850	1 500	1 250	1 100	935	750	630	540	475	420	380	305	255	220	195	155
4	14 350	10 750	8 600	6 150	4 800	3 950	2 700	2 050	1 700	1 400	1 200	1 050	845	705	610	535	475	430	345	285	245	215	175
4,5	-	11 950	9 550	6 850	5 350	4 350	3 000	2 300	1 850	1 550	1 350	1 200	940	785	675	590	525	475	-	rpm (1/min)			

Adaptadores Tipo HILTI



CÓDIGO	Tipo	Rosca	Características	PCS	€
MDCA01	HILTI DD-BU	1" 1/4 W.	Chave Macho 41	INTERNO 1/2" Gas Fêmea 'Furo Ø18	1 164,26
MDCA02	HILTI DD-BL	1" 1/4 W.	Adaptador com Chave fêmea Chave Macho 41	INTERNO 1/2" Gas Fêmea 'Furo Ø18	1 174,93
MDCA03	HILTI DD-BL	1" 1/4 W.	Adaptador Cônico 3+3 Chave Macho 41	3+3 Fresado INTERNO 1/2 Gas Fêmea	1 60,83

COROA SEGMENTADA PROFISSIONAL PARA BETÃO - CORTE A SECO

DIAMOND CORE DRILLS DRY CUTTING FOR DRILLING MACHINES
FORETS DIAMANTES COUPE À SEC POUR CAROTEUSES



Corpo Exterior Cônico

CÓDIGO	Ø	Espessura	Dentes	€
MDC100	32	3,2	3	75,20
MDC101	37	3,2	3	76,80
MDC102	42	3,2	3	79,20
MDC103	52	3,5	4	92,00
MDC104	57	3,5	4	94,40
MDC105	62	3,5	4	96,80
MDC106	67	3,5	4	101,60
MDC107	72	3,5	4	108,80
MDC108	82	3,5	5	114,40
MDC109	92	3,5	5	121,60
MDC110	102	3,5	6	131,20
MDC111	107	3,5	6	143,20
MDC112	112	3,5	6	154,40
MDC113	122	3,5	6	159,20
MDC114	127	3,5	6	166,40
MDC115	132	3,5	6	176,10
MDC116	142	3,5	6	179,20
MDC117	152	3,5	7	190,40
MDC118	162	3,5	7	213,60
MDC119	182	3,8	8	252,00
MDC120	202	3,8	8	268,00

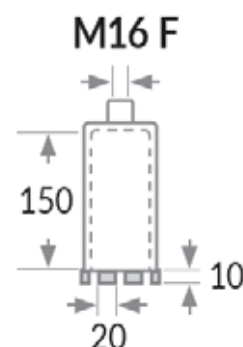

Brocas de coroa equipada com segmentos que garantem tempos de perfuração mais rápidos em todos os materiais, incluindo o betão armado mais resistente.

Os segmentos ranhurados para descarga de materiais são soldados a laser a um corpo de aço espiral e cônico de alta qualidade, garantindo resistência a temperaturas elevadas e aos impactos gerados pela micro-percussão.



Adaptador

CÓDIGO	Tipo	Máquina			€
MDCA20	D3	M18F	M16 M	19 mm	27,30
MDCA21	G0	Ø13 L100	M16 M	19 mm	27,30
MDCA22	G1	Ø13 L200	M16 M	19 mm	23,89
MDCA23	G2	Ø13 L300	M16 M	19 mm	32,42
MDCA24	X0	SDS+L100	M16 M	19 mm	48,64
MDCA25	X1	SDS+L200	M16 M	19 mm	48,64
MDCA26	X2	SDS+L300	M16 M	19 mm	57,17
MDCA27	A0	SDS MAX L100	M16 M	19 mm	80,21
MDCA28	A1	SDS MAX L200	M16 M	19 mm	94,72
MDCA29	A2	SDS MAX L300	M16 M	19 mm	110,08
MDCA30	V1	1"1/4 WF L150	M16 M	19 mm	75,05
MDCA31	V2	1"1/4 WF L250	M16 M	19 mm	87,04
MDCA32	SDS Plus	M18F	M16 M		59,73

ESCREADORES ESPECIAL GRÉS

COUNTERSINK STONEWARE
ALÉSOIR POUR GRÉS

Escreadores Especial Grés

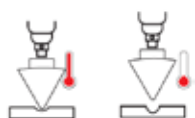

CÓDIGO	Ø	Rosca	€
MDGE01	02 - 38	M14	34,13
MDGE02	20 - 48	M14	44,00

Jogo Brocas Diamantadas+ Escreador (5pcs)



Jogo Brocas Diamantadas+ Escreador (6pcs)



CÓDIGO	Ø BROCA	Ø ESCREADOR	€
MDG60	6 - 8 - 10 - 12	2 - 38	157,00

CÓDIGO	Ø BROCA	Ø ESCREADOR	€
MDG61	20 - 27 - 30 35 - 50	20 - 48	262,50

COROAS DE DESBASTE E ACABAMENTO E MÓS TIPO TAÇA CÓNICA PARA PEDRA

REMOVING CROWNS AND CONICAL BOWL WHEELS FOR STONE

MEULES POUR APLANIR ET POLIR POUR LA PIERRE

Para Desbaste

CÓDIGO	Medida	PCS	€
MDD190	105	1	34,29

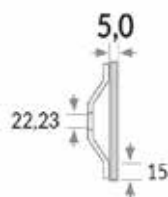

Para Acabamento

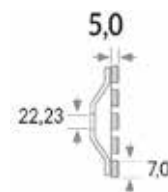

CÓDIGO	Medida	Segmentos	PCS	€
MDD191	100	7 + 7	1	42,86

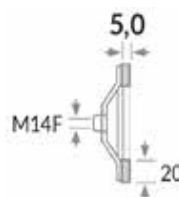

Para Desbaste

CÓDIGO	Medida	Rosca	PCS	€
MDD182	100	M14	1	54,29



Peça integral				Trabalha a seco	* Com corpo em alumínio * Anti-vibração
---------------	---	---	---	-----------------	--

Mós Tipo Taça Cónica para Pedra (100×90×55) Universal

CÓDIGO	Medida	Rosca Métrica	PCS	€
MD57	60	M 14 × 2	1	16,51
MD58	80	M 14 × 2	1	16,51

Venda até ao fim de existência

NB: Mais medidas sob consulta



A	B	C	D
100	90	55	14

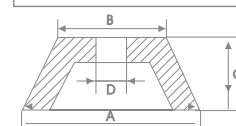



DISCOS DE DIAMANTE

DIAMOND DISCS
DISQUES DIAMANT

Económico



CÓDIGO	Medida	Segmento Esp. / Alt.	Furo	PCS	€
MDD100	115	2,1 x 10	22,2	1	6,49
MDD101	125	2,1 x 10	22,2	1	8,26
MDD103	230	2,6 x 10	22,2	1	17,14
MDD104	300	3 x 10	25,4	1	40,00
MDD105	350	3 x 10	25,4	1	53,33

Uso geral				Corte a seco	- Garantia de segurança. - Máximo rendimento. - Uma excelente relação qualidade / preço.
-----------	---	---	---	--------------	--



Contínuo Normal (Flat Core)



CÓDIGO	Medida	Segmento Esp. / Alt.	Furo	PCS	€
MDD146	115	2,1 x 7	22,2	1	6,49
MDD147	125	2,1 x 7	22,2	1	8,26
MDD149	230	2,6 x 8	22,2	1	17,14
MDD150	300	3 x 8	25,4	1	54,76
MDD151	350	3 x 8	25,4	1	60,49

Uso geral				Corte a seco	- Design do diamante melhorado para um rendimento superior.
-----------	--	--	--	--------------	---



Turbo Ondulado (Waved Core)

CÓDIGO	Medida	Segmento Esp. / Alt.	Furo	PCS	€
MDD162	115	2,1 x 7	22,2	1	17,00
MDD165	230	2,6 x 8	22,2	1	40,00

Uso geral				Corte a seco	Combinação perfeita entre o diamante e a ondulação do disco, o disco Kodia com maior reputação.
-----------	---	---	---	--------------	---



Banda Lisa

CÓDIGO	Medida	Segmento Esp. / Alt.	Furo	PCS	€
MDD185	115	1,6 x 7	22,2	1	5,71
MDD186	125	1,6 x 7	22,2	1	6,57
MDD188	230	1,6 x 7	22,2	1	21,43
MDD189	300	2 x 8	25,4	1	65,50

				Corte a húmido	- Disco profissional especial para corte de telha e cerâmica.
--	---	---	---	----------------	---



Eletrodepositados

CÓDIGO	Medida	Segmento Esp. / Alt.	Furo	PCS	€
MDD192	115	2,1 x 7	22,2	1	25,71
MDD193	125	2,1 x 7	22,2	1	34,29
MDD194	180	2,4 x 7	22,2	1	48,57
MDD195	230	2,6 x 7	22,2	1	60,00

			Corte a seco	- Qualidade aprovada e garantida. - Corte perfeito, não deixa rebarba.
--	---	---	--------------	---



DISCOS DE DIAMANTE

DIAMOND DISCS
DISQUES DIAMANT

Ultra Super Turbo (World Top)

CÓDIGO	Medida	Segmento Esp. / Alt.	Furo	PCS	€
MDD340	115	2,6 x 8	22,2	1	20,00
MDD341	125	2,6 x 8	22,2	1	22,86
MDD342	180	3,1 x 8	22,2	1	45,71
MDD344	230	3,1 x 8	22,2	1	48,57
MDD345	300	3,1 x 8	25,4	1	85,71
MDD346	350	3,1 x 8	25,4	1	97,14



a
SECO

Alto rendimento e anti-vibração.
- Corte contínuo sem ser necessário a paragem do disco para arrefecimento.



Disco Grés Premium Rendimento +30% a 40% no Corte

CÓDIGO	Medida	Segmento Esp. / Alt.	Furo	PCS	€
MDD360	115	1,4 x 10	22,2	1	22,86



Corte a húmido

- Alto rendimento.
- Anti - vibração.
- Corte perfeito e silencioso.



Turbo Grés

CÓDIGO	Medida	Segmento Esp. / Alt.	Furo	PCS	€
MDD350	115	1 x 10	22,2	1	18,67
MDD351	125	1 x 10	22,2	1	21,35
MDD352	230	1,5 x 10	22,2	1	57,50



Corte a húmido

- Alto rendimento.
- Anti - vibração.
- Corte perfeito e silencioso.



Banda Lisa Turbo World Top (Especial para Grés)

CÓDIGO	Medida	Segmento Esp. / Alt.	Furo	PCS	€
MDD330	115	1,2 x 7	22,2	1	17,14
MDD331	125	1,2 x 7	22,2	1	20,00
MDD333	180	1,4 x 7	22,2	1	32,00
MDD334	200	1,6 x 8	25,4	1	34,57
MDD335	230	1,6 x 8	25,4	1	38,29



Corte a húmido

- Alto rendimento.
- Anti - vibração.
- Corte perfeito e silencioso.



Laser Asfalto (Premium)

CÓDIGO	Medida	Segmento Esp. / Alt.	Furo	PCS	€
MDD196	300	2,8 x 10	25,4	1	65,71
MDD197	350	2,8 x 10	25,4	1	100,00
MDD198	400	3 x 10	25,4	1	132,80
MDD199	450	3 x 10	25,4	1	157,33
MDD200	500	3,6 x 10	25,4	1	185,71
MDD201	600	3,6 x 10	25,4	1	271,43



Corte a húmido

- Especial asfalto e betão fresco.
- Os segmentos soldados a laser garantem a máxima segurança.



FRESAS PARA MARTELO COM DENTES EM METAL DURO COM FURO ROSCADO

HAMMER CUTTERS WITH TEETH IN CARBED METAL WITH THREADED HOLE
 FRAISES À MARTEAU AVEC DENTS EN MÉTAL DUR AVEC ALÉSAGE FILETÉ

METAL DURO

CÓDIGO	Ø	Rosca	Nº dentes	Lmm	PCS	€
MFMD25	25	M-16	4	75	1	22,57
MFMD30	30	M-16	4	75	1	25,69
MFMD35	35	M-16	4	75	1	30,79
MFMD40	40	M-16	5	75	1	32,85
MFMD45	45	M-16	5	75	1	45,20
MFMD50	50	M-22	6	75	1	37,88
MFMD65	65	M-22	6	75	1	45,21
MFMD80	80	M-22	6	75	1	63,69
MFMD90	90	M-22	6	75	1	73,94
MFMD91	100	M-22	8	75	1	82,18
MFMD95	112	M-22	8	75	1	102,70
MFMD93	125	M-22	10	80	1	127,38
MFMD94	150	M-22	12	80	1	172,59



Cabo Hexagonal

CÓDIGO	Rosca	Lmm	PCS	€
MFAMD100	M-16	100 mm	1	14,52
MFAMD221	M-16	220 mm	1	22,96
MFAMD122	M-22	100 mm	1	44,80
MFAMD222	M-22	220 mm	1	22,96



Cabo SDS-Plus

CÓDIGO	Rosca	Lmm	PCS	€
MFSDS100	M-16	100 mm	1	14,52
MFSDS220	M-16	220 mm	1	22,96
MFSDS122	M-22	100 mm	1	15,25
MFSDS222	M-22	220 mm	1	22,96



Broca

CÓDIGO	Lmm	PCS	€
MFAB120	8 x 120	1	4,10



Expositor	
Composição 24 unidades	
UN	Descrição
8	Fresas (30,35,40,50,65,80,90,100)
1	Cabo Hexagonal M16 - 100mm
1	Cabo Hexagonal M22 - 100mm
1	Cabo Hexagonal M16 - 220mm
1	Cabo Hexagonal M22 - 220mm
1	Cabo SDS M16 - 100mm
1	Cabo SDS M22 - 100mm
1	Cabo SDS M16 - 220mm
1	Cabo SDS M22 - 220mm
8	Brocas 8x120mm

OFERTA EXPOSITOR

FRESAS P/ MARTELO C/ DENTES EM METAL DURO C/ ROSCA E MOLLA DE ACOPLAMENTO

HAMMER CUTTERS WITH TEETH IN CARBED METAL WITH THREAD AND COUPLING SPRING

FRAISES À MARTEAU AVEC DENTS EN MÉTAL DUR AVEC FILETAGE ET RESSORT D'ACCOUPLLEMENT

METAL DURO

CÓDIGO	Ø	Nº dentes	Lmm	PCS	€
MFMDR01	40	5	100	1	43,11
MFMDR02	50	6	100	1	53,87
MFMDR03	60	6	100	1	78,00
MFMDR04	66	7	100	1	92,47
MFMDR05	70	8	100	1	125,69
MFMDR06	80	8	100	1	129,29
MFMDR07	90	8	100	1	141,07
MFMDR08	100	10	100	1	155,58
MFMDR09	110	12	100	1	168,47
MFMDR10	125	12	100	1	208,55
MFMDR11	150	14	100	1	251,01



Elevado rendimento e sempre desmontável graças à mola de acoplamento



Cabo SDS MAX com Mola

CÓDIGO	Lmm	PCS	€
MFMAXR250	250 mm	1	51,88
MFMAXR450	450 mm	1	71,80
MFMAXR600	600 mm	1	99,77



Mola de Acoplamento

CÓDIGO	PCS	€
MFMDR99	1	0,80



Cunha

CÓDIGO	Ø	PCS	€
MFC01	9,5 x 100	1	6,74



Broca de Centrar

CÓDIGO	Ø	PCS	€
MFMAXC12	12 x 135	1	9,92



Expositor

Composição 29 unidades

UN	Descrição
7	Fresas (40,50,60,66,80,90,100)
3	CaboSDS MAX 250mm
3	Cabos SDS MAX 450mm
6	Brocas 12 x 135
10	Molas

SERRAS CRANEANAS BIMETÁLICAS HSS PARA AÇO E METAIS NÃO FERROSOS

HSS BIMETAL HOLE SAWS FOR STEEL AND NON-FERROUS METALS

SCIES À GRUE BIMÉTALLIQUES HSS POUR L'ACIER ET LES MÉTAUX NON FERREUX

CÓDIGO	Ø mm	Ø"	PCS	€
MV2000	14	9/16	1	5,58
MV2001	16	5/8	1	5,58
MV2002	17	11/16	1	5,58
MV2003	19	3/4	1	5,58
MV2004	20	25/32	1	5,58
MV2005	21	13/16	1	5,58
MV2006	22	7/8	1	5,58
MV2007	23	14/16	1	5,58
MV2008	24	15/16	1	5,58
MV2009	25	1"	1	6,39
MV2010	27	1" 1/16	1	6,39
MV2011	28	3/32	1	6,39
MV2012	29	1" 1/18	1	6,39
MV2013	30	1" 3/16	1	6,39
MV2014	32	1" 1/4	1	6,39
MV2015	33	1" 5/16	1	6,84
MV2016	35	1" 3/8	1	6,84
MV2017	37	1" 7/16	1	6,84
MV2018	38	1" 1/2	1	7,68
MV2019	40	1" 9/16	1	7,68
MV2020	41	1" 5/8	1	7,68
MV2021	43	1" 11/16	1	7,68
MV2022	44	1" 3/4	1	8,14
MV2023	46	1" 13/16	1	8,14
MV2024	48	1" 7/8	1	8,14
MV2025	50	31/32	1	9,04
MV2026	51	2"	1	9,04
MV2027	52	2" 1/16	1	9,04
MV2028	54	2" 1/8	1	9,04
MV2029	57	2" 1/4	1	9,04
MV2030	59	2" 5/16	1	9,04
MV2031	60	2" 3/8	1	9,04
MV2032	63		1	11,08
MV2033	64	2" 1/2	1	11,08
MV2034	65	2" 3/16	1	11,08
MV2035	67	2" 5/8	1	11,08
MV2036	68	2" 11/16	1	11,08
MV2037	70	2" 3/4	1	11,95
MV2038	73	2" 7/8	1	11,95
MV2039	76	3"	1	11,95
MV2040	79	3" 1/8	1	11,95
MV2041	83	3" 1/4	1	11,95
MV2042	86	3" 3/8	1	13,63
MV2043	89	3" 1/2	1	13,63
MV2044	92	3" 5/8	1	13,63
MV2045	95	3" 3/4	1	13,63
MV2046	98	3" 7/8	1	13,63
MV2047	102	4"	1	16,66
MV2048	105	4" 1/8	1	16,66
MV2049	108	4" 1/4	1	19,36
MV2050	111	4" 3/8	1	20,44
MV2051	114	4" 1/2	1	20,44
MV2052	121	4" 3/4	1	25,70
MV2053	127	5"	1	26,86
MV2054	140	5" 1/2	1	30,19
MV2055	152	6"	1	32,98
MV2056	160	6" 5/16	1	38,39
MV2057	210	8" 9/32	1	49,99

HSS



Para trabalhar inox, reduzir a rotação em 50%



Expositor de Serras Craneanas em Acrílico

Composição 32 unidades

1 serra de cada:

Ø 16, 19, 22, 25, 29, 32, 38, 41, 43, 44, 48, 51, 54, 57, 60, 65, 67, 70, 76, 89, 92, 95, 102, 105, 114

2 brocas guia 6,35: 1x comp. 75mm; 1x comp. 104mm

5 adaptadores: 1xGBM 32 a 250; 2xGBP 14 a 30; 2xGBS 32 a 250

OFERTA EXPOSITOR

CÓDIGO

€

JOGOS DE SERRAS CRANEANAS BIMETÁLICAS HSS

HSS BIMETAL HOLE SAWS SETS

JEUX DE SCIÉS À GRUE BIMÉTALLIQUES HSS

HSS



Jogo para Canalizadores

Composição 8 Peças
Referência CV6C

1 serra de cada:
Ø 19, 22, 29,
38, 44, 57
1 Adaptador GBP
1 Adaptador GBS

CÓDIGO	€
MV2501	51,29



Jogo para Instaladores

Composição 11 Peças
Referência CV9-I

1 serra de cada:
Ø 19, 22, 29, 35,
38, 44, 51, 57, 64
1 Adaptador GBP
1 Adaptador GBS

CÓDIGO	€
MV2502	81,86



Jogo para Eletricistas

Composição 8 Peças
Referência CV6E

1 serra de cada:
Ø 22, 29, 35,
44, 51, 64
1 Adaptador GBP
1 Adaptador GBS

CÓDIGO	€
MV2503	61,39



Jogo Industrial

Composição 13 Peças
Referência CV11-I

1 serra de cada:
Ø 19, 22, 25, 32, 35, 38,
44, 51, 57, 64, 76
1 Adaptador GBP
1 Adaptador GBS

CÓDIGO	€
MV2504	102,04

Brocas Guia



CÓDIGO	Ø Medida	PCS	€
MVG075	6,35mm - comprimento 75 mm	1	2,02
MVG110	6,35mm - comprimento 104mm	1	3,61

Adaptadores



Adaptador com acoplamento rápido

CÓDIGO	Tipo	Ø	€
MVA014	GBP	14 a 30	3,87
MVA032	GBM	32 a 250	5,29
MVA250	GBS	32 a 250	10,45

SERRAS CRANEANAS BIMETÁLICAS HSS-CO 8% PARA INOX

HSS-CO 8% BIMETAL HOLE SAWS FOR INOX

SCIES À GRUE BIMÉTALLIQUES HSS-CO 8% POUR L'ACIER INOXYDABLE

CÓDIGO	Ø mm	Ø"	PCS	€
MV3000	14	9/16	1	8,54
MV3001	16	5/8	1	8,54
MV3002	17	11/16	1	8,54
MV3003	19	3/4	1	8,54
MV3004	20	25/32	1	8,54
MV3005	21	13/16	1	8,54
MV3006	22	7/8	1	8,54
MV3007	24	15/16	1	8,54
MV3008	25	1"	1	9,60
MV3009	27	1" 1/16	1	9,60
MV3010	29	1" 1/8	1	9,60
MV3011	30	1" 3/16	1	9,60
MV3012	32	1" 1/4	1	9,60
MV3013	33	1" 5/16	1	9,60
MV3014	35	1" 3/8	1	10,61
MV3015	37	1" 7/16	1	10,61
MV3016	38	1" 1/2	1	10,61
MV3017	40	1" 9/16	1	10,90
MV3018	41	1" 5/8	1	10,90
MV3019	43	1" 11/16	1	10,90
MV3020	44	1" 3/4	1	12,08
MV3021	45		1	12,08
MV3022	46	1" 13/16	1	12,08
MV3023	48	1" 7/8	1	12,08
MV3024	50		1	12,52
MV3025	51	2"	1	12,52
MV3026	52	2" 1/16	1	14,66
MV3027	54	2" 1/8	1	14,66
MV3028	57	2" 1/4	1	14,66
MV3029	59	2" 5/16	1	14,66
MV3030	60	2" 3/8	1	14,66
MV3031	64	2" 1/2	1	15,80
MV3032	65	2" 3/16	1	15,80
MV3033	67	2" 5/8	1	16,11
MV3034	68	2" 11/16	1	16,11
MV3035	70	2" 3/4	1	16,11
MV3036	73	2" 7/8	1	16,11
MV3037	75		1	16,76
MV3038	76	3"	1	16,76
MV3039	79	3" 1/8	1	17,11
MV3040	83	3" 1/4	1	17,87
MV3041	86	3" 3/8	1	17,87
MV3042	89	3" 1/2	1	17,87
MV3043	92	3" 5/8	1	20,09
MV3044	95	3" 3/4	1	21,88
MV3045	98	3" 7/8	1	22,04
MV3046	100		1	22,04
MV3047	102	4"	1	22,44
MV3048	105	4" 1/8	1	26,80
MV3049	108	4" 1/4	1	30,73
MV3050	111	4" 3/8	1	36,29
MV3051	114	4" 1/2	1	42,43
MV3052	121	4" 3/4	1	48,02
MV3053	127	5"	1	56,26
MV3054	140	5" 1/2	1	61,34
MV3055	152	6"	1	71,48

HSS-CO



Linha para Expositor

Composição 40 peças (composto por 2 linhas)

2 serras de cada:

Ø 16, 19, 20, 38, 40, 44, 51, 54, 57, 60

3 serras de cada:

Ø 22, 24, 25, 27, 29, 30, 32, 35

2 adaptadores 14 a 30 e 2 adaptadores 32 a 250



Expositor de Serras Craneanas em Acrílico

Composição 32 unidades

1 serras de cada:

Ø 16, 19, 22, 25, 29, 32, 38, 41, 43, 44, 48, 51, 54, 57, 60, 65, 67, 70, 76, 89, 92, 95, 102, 105, 114

2 brocas guia 6,35: 1x comp. 75mm; 1x comp.104mm

5 adaptadores: 1xGBM 32 a 250; 2xGBP 14 a 30; 2xGBS 32 a 250

JOGOS DE SERRAS CRANEANAS BIMETÁLICAS HSS-CO 8% PARA INOX

HSS-CO 8% BIMETAL HOLE SAWS SETS FOR INOX

JEUX DE SCIÉS À GRUE BIMÉTALLIQUES HSS-CO8 % POUR L'ACIER INOXYDABLE

HSS-CO



Jogo para Canalizadores

Composição 9 Peças

1 serra de cada:
 Ø 19, 22, 29,
 38, 44, 57
 1 Adaptador GBP
 1 Adaptador GBS
 1 Acessório

CÓDIGO	€
MV3501	92,02



Jogo para Instaladores

Composição 12 Peças

1 serra de cada:
 Ø 19, 22, 29, 35,
 38, 44, 51, 57, 64
 1 Adaptador GBP
 1 Adaptador GBS
 1 Acessório

CÓDIGO	€
MV3502	147,22



Jogo para Eletricistas

Composição 9 Peças

1 serra de cada:
 Ø 22, 29, 35,
 44, 51, 64
 1 Adaptador GBP
 1 Adaptador GBS
 1 Acessório

CÓDIGO	€
MV3503	115,32



Jogo Industrial

Composição 13 Peças

1 serra de cada:
 Ø 19, 22, 25, 30, 35, 40,
 51, 60, 64, 76, 83
 1 Adaptador GBP
 1 Adaptador GBS

CÓDIGO	€
MV3504	184,11

Brocas Guia



CÓDIGO	Ø Medida	PCS	€
MVG075	6,35mm - comprimento 75 mm	1	2,02
MVG110	6,35mm - comprimento 104mm	1	3,61

Adaptadores



Adaptador com acoplamento rápido

CÓDIGO	Tipo	Ø	€
MVA014	GBP	14 a 30	3,87
MVA032	GBM	32 a 250	5,29
MVA250	GBS	32 a 250	10,45

SERRA CRANEANA TCT COM DENTES EM METAL DURO MULTIMATERIAL

TCT BIMETAL HOLE SAWS WITH TEETH IN CARBED METAL
SCIE À GRUE MULTI-MATERIAUX EN MÉTAL DUR DE TCT

METAL DURO

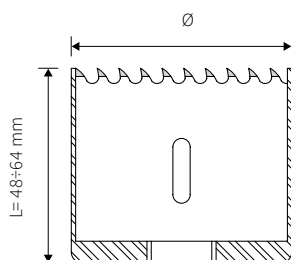

Aço



Madeira



Cerâmica



CÓDIGO	Ø mm	Ø Polegadas	d Rosca	€
MVT01*	19	3/4	UNF 1/2 × 20	13,86
MVT02*	22	7/8		15,73
MVT03*	25	1"		15,73
MVT04*	29	1-1/8		16,86
MVT05*	32	1-1/4	UNF 5/8 × 18	17,70
MVT06*	35	1-3/8		17,70
MVT07*	38	1-1/2		18,96
MVT09*	44	1-3/4		19,91
MVT10*	51	2"		21,50
MVT11*	57	2-1/4		25,91
MVT12*	64	2-1/2		27,15
MVT13*	68	2-23/32		28,46
MVT14*	76	3"		29,72
MVT15*	89	3-1/2		35,55
MVT16*	108	4-1/4		46,22

*Até fim de existência



Jogo Serras Craneanas TCT Multi

Composição 8 Peças

1 x Ø 19 mm
1 x Ø 22 mm
1 x Ø 29 mm
1 x Ø 38 mm
1 x Ø 44 mm
1 x Ø 57 mm
2 x Ø 7 × 100 mm

CÓDIGO

€

MVT20*

181,36

*Até fim de existência

ADAPTADOR PARA SERRAS CRANEANAS ULTRA RÁPIDO MLOCK

QUICK CHANGE ARBOR FOR BIMETAL HOLE SAWS
ADAPTATEUR DE SCIE À GRUE ULTRA RAPIDE MLOCK

MLOCK

SISTEMA DE APERTO ULTRA RÁPIDO



Adaptador Universal
1/2" X 20 UNF
5/8" X 18 UNF

Para todas as marcas de serras de 14 to 305 mm

Cabo facetado
para máximo aperto na bucha

ADAPTADOR PARA SERRAS CRANEANAS ULTRA RÁPIDO MLOCK

QUICK CHANGE ARBOR FOR BIMETAL HOLE SAWS
ADAPTATEUR DE SCIE À GRUE ULTRA RAPIDE MLOCK

KIT de adaptador para Serras Craneanas **MLOCK**



Kit de Adaptador	
Composição 5 peças	
1 x Adaptador M-LOCK	
1 x Broca L 95 mm	
1 x Broca L 100 mm	
1 x Adaptador 1/2" X 20 UNF	
1 x Adaptador 5/8" X 18 UNF	
CÓDIGO	€
MVA300	22,69

Acessórios para Adaptador **MLOCK**



Acessórios	
Composição 6 peças	
2 x Adaptador 1/2" x 20 UNF	
3 x Adaptador 5/8" x 18 UNF	
1 x Broca L 95 mm	
CÓDIGO	€
MVA301	13,28

A close-up photograph of a wooden surface, showing a mix of wood grain patterns. A prominent feature is a large, rectangular section of wood with a very distinct, wavy, and cracked grain pattern, possibly a type of aged or weathered wood. This section is surrounded by smoother, more uniform wood grain. A solid green horizontal bar is overlaid across the middle of the image, containing the text 'WOOD/BOIS' in white, bold, uppercase letters.

WOOD/BOIS

A detailed close-up photograph of wood grain, showing various textures and colors from light tan to dark brown. The image is split horizontally by a green banner. The top half shows a cross-section of wood with a distinct, regular grain pattern. The bottom half shows a more complex, wavy grain pattern with a prominent knot. The lighting highlights the natural texture and grain of the wood.

MADEIRA

BROCA PARA MADEIRA 4 CORTES CABO HEXAGONAL C. V.

WOOD DRILL 4 CUTS HEXAGONAL HANDLE
FORET À BOIS 4 COUPES POIGNÉE HEXAGONALE

CROMO VANADIUM

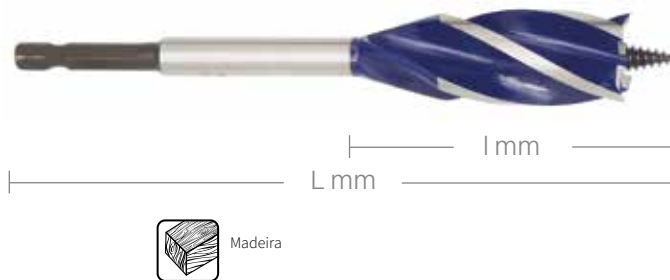

CÓDIGO	Ø	Polegadas	l	L	PCS	€
MBE300	10	1/4	65	165	1	10,83
MBE301	12	1/4	65	165	1	11,16
MBE302	14	1/4	65	165	1	13,44
MBE303	16	1/4	65	165	1	14,29
MBE304	18	1/4	65	165	1	15,53
MBE305	20	1/4	65	165	1	15,98
MBE306	22	1/4	65	165	1	17,94
MBE307	24	1/4	65	165	1	20,09
MBE308	25	1/4	65	165	1	22,12
MBE309	26	1/4	65	165	1	22,57
MBE310	28	1/4	65	165	1	24,01
MBE311	30	1/4	65	165	1	25,70
MBE312	32	1/4	65	165	1	28,16

Set Brocas Madeira	
Composição 6 peças	
1 x Ø 16 mm	
1 x Ø 18 mm	
1 x Ø 20 mm	
1 x Ø 22 mm	
1 x Ø 25 mm	
1 x Ø 32 mm	
CÓDIGO	€
MBE315	114,02



BROCAS FORMA LEWIS PARA MADEIRA C.V.

LEWIS TYPE DRILLS FOR WOOD
FORETS SPIRALE VIS EN POINTE

CROMO VANADIUM

Cabo "SDS Plus"



CÓDIGO	Ø	L1	L2	PCS	€
BLSDS04	8,00	235	160	1	9,58
BLSDS05	10,00	235	160	1	10,08
BLSDS07	12,00	235	160	1	10,82
BLSDS09	14,00	235	160	1	12,31
BLSDS11	16,00	235	160	1	13,65
BLSDS12	18,00	235	160	1	16,23
BLSDS14	20,00	235	160	1	18,41
BLSDS15	22,00	235	160	1	20,57
BLSDS16	24,00	235	160	1	22,56

Cabo Hexagonal



CÓDIGO	Ø	L1	L2	PCS	€
BLM01	6,00	235	160	1	8,15
BLM04	8,00	235	160	1	8,60
BLM05	10,00	235	160	1	9,08
BLM07	12,00	235	160	1	10,46
BLM09	14,00	235	160	1	11,87
BLM11	16,00	235	160	1	13,18
BLM12	18,00	235	160	1	14,62
BLM14	20,00	235	160	1	16,59
BLM15	22,00	235	160	1	18,52
BLM16	24,00	235	160	1	20,31

BROCAS PUAS PLANAS PARA MADEIRA E DERIVADOS (CABO HEXAGONAL) C.V.

FLAT DRILLS FOR WOOD (HEXAGONAL SHANK)

MÊCHE PLATE (CÂBLE HEXAGONAL)

CROMO VANADIUM



CÓDIGO	Ø	l mm	L mm	PCS	€
BPM01	6,00	6,35	150	1	1,85
BPM02	8,00	6,35	150	1	1,85
BPM03	9,00	6,35	150	1	1,86
BPM04	10,00	6,35	150	1	1,88
BPM05	11,00	6,35	150	1	1,88
BPM06	12,00	6,35	150	1	1,88
BPM07	13,00	6,35	150	1	1,99
BPM08	14,00	6,35	150	1	1,99
BPM09	15,00	6,35	150	1	2,05
BPM10	16,00	6,35	150	1	1,90
BPM26	17,00	6,35	150	1	1,90
BPM11	18,00	6,35	150	1	1,93
BPM12	19,00	6,35	150	1	1,95
BPM13	20,00	6,35	150	1	1,95
BPM27	21,00	6,35	150	1	2,05
BPM14	22,00	6,35	150	1	2,05
BPM15	24,00	6,35	150	1	2,05
BPM16	25,00	6,35	150	1	2,21
BPM17	26,00	6,35	160	1	2,20
BPM29	27,00	6,35	160	1	2,46
BPM18	28,00	6,35	160	1	2,46
BPM30	29,00	6,35	160	1	2,62
BPM19	30,00	6,35	160	1	2,62
BPM20	32,00	6,35	160	1	2,89
BPM21	34,00	6,35	160	1	3,24
BPM22	35,00	6,35	160	1	3,24
BPM23	36,00	6,35	160	1	4,33
BPM24	38,00	6,35	160	1	4,41
BPM25	40,00	6,35	160	1	4,58



Jogo de Brocas Planas	
Composição 6 brocas	
Ø	UN
10,00	1
12,00	1
16,00	1
18,00	1
20,00	1
25,00	1
CÓDIGO	€
BPMJ01	16,98

BROCAS COM PONTA GUIA PARA MADEIRA DIN7487 C.V.

CENTER POINT DRILLS FOR WOOD DIN7487
FORETS BOIS AUTO-CENTREUR

CROMO VANADIUM



CÓDIGO	Ø	D1	L1 mm	L2 mm	PCS	€
BPG30	3,00	3	60	33	1	0,57
BPG31	4,00	4	75	43	1	0,65
BPG32	5,00	5	85	52	1	0,67
BPG33	6,00	6	93	57	1	0,83
BPG34	7,00	7	109	69	1	0,96
BPG35	8,00	8	117	75	1	0,86
BPG36	9,00	9	125	81	1	0,96
BPG37	10,00	10	133	87	1	1,12
BPG38	11,00	10	142	94	1	1,64
BPG39	12,00	10	151	101	1	1,68
BPG40	13,00	10	151	101	1	2,27
BPG41	14,00	10	160	108	1	2,52
BPG42	15,00	10	169	114	1	2,99
BPG43	16,00	10	178	120	1	3,18
BPG44	18,00	10	191	130	1	5,38
BPG45	20,00	10	205	140	1	6,57
BPG46	22,00	13	210	140	1	10,29
BPG47	24,00	13	215	140	1	12,06
BPG48	26,00	13	215	140	1	14,38
BPG49	28,00	13	220	140	1	16,97
BPG50	30,00	13	220	140	1	20,19

BROCAS TIPO FORSTNER COM PONTA EM METAL DURO

FORSTNER TYPE DRILLS FOR WOOD (CARBIDE TIP)
MÈCHE À FAÇONNER (DENT CARBURE)

METAL DURO



CÓDIGO	Ø	D1	L mm	PCS	€
BFM02	15,00	8	90	1	22,77
BFM08	16,00	8	90	1	22,77
BFM09	19,00	8	90	1	22,77
BFM03	20,00	8	90	1	24,04
BFM10	22,00	8	90	1	24,43
BFM11	23,00	8	90	1	24,10
BFM04	25,00	8	90	1	26,03
BFM05	26,00	8	90	1	28,90
BFM06	30,00	8	90	1	29,30
BFM07	35,00	10	90	1	30,91

SERRAS DE PASTILHA COM DENTES EM METAL DURO

CARBIDE TIPPED CIRCULAR SAW BLADES

SCIES À PLAQUETTES AVEC DENTS EN MÉTAL DUR

Madeira - Dente Alternado

CÓDIGO	Ø	Esp.	Furo	Nºdentes	PCS	€
MSP070	250	3,20	30	40DA	60,38	56,45
MSP071	250	3,20	30	60DA	73,96	67,69
MSP072	250	3,20	30	80DA	88,23	81,21
MSP073	300	3,20	30	48DA	65,97	64,87
MSP074	300	3,20	30	72DA	89,14	81,57
MSP075	300	3,20	30	96DA	100,09	91,61
MSP076	350	3,50	30	54DA	92,68	84,73
MSP077	350	3,50	30	72DA	105,57	96,57
MSP078	400	3,50	30	60DA	110,71	101,31
MSP079	400	3,50	30	96DA	142,10	129,97
MSP080	450	4,00	30	66DA	156,82	153,87
MSP081	450	4,00	30	138DA	261,34	217,00
MSP082	500	4,00	30	72DA	194,28	187,39
MSP083	500	4,00	30	144DA	292,78	255,20

Aplicação:

Serras circulares para corte longitudinal e transversal de madeira maciça (macia e dura) e derivados de madeira sem revestimentos.



METAL DURO

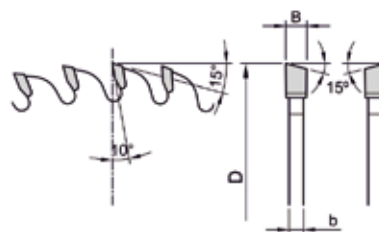

Laminados - Dente Trapezoidal

CÓDIGO	Ø	Esp.	Furo	Nºdentes	PCS	€
MSP090	250	3,20	30	60DP	85,46	74,46
MSP091	250	3,20	30	80DP	99,32	86,54
MSP092	300	3,20	30	72DP	100,32	91,72
MSP093	300	3,20	30	96DP	108,88	99,62
MSP094	350	3,50	30	84DP	128,06	117,11
MSP095	350	3,50	30	108DP	147,00	134,49

Aplicação:

Serras circulares para corte de derivados de madeira com revestimento como MDF, aglomerados, entre outros.



METAL DURO

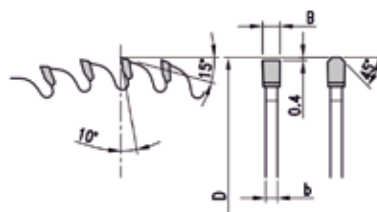

SERRAS CIRCULARES COM DENTES EM METAL DURO

CARBIDE TIPPED CIRCULAR SAW BLADES
SCIES CIRCULAIRES À DENTS EN MÉTAL DUR

Dry Cut (Painéis Sandwich)

CÓDIGO	Ø	Esp.	Furo	Nºdentes	Vel. R.P.M.	PCS	€
MSP100	180	2,20	20	32	2500	1	63,14
MSP101	180	2,20	30	32	2500	1	63,14
MSP102	190	2,20	30	38	2200	1	77,35
MSP103	230	2,20	30	44	2200	1	73,50
MSP104	250	2,20	30	48	2200	1	94,73
MSP105	250	2,20	30	60	1600	1	106,60
MSP106	270	2,20	30	60	1600	1	123,83
MSP107	305	2,20	25,4	60	1600	1	129,77
MSP108	305	2,20	30	60	1600	1	129,77
MSP109	305	2,20	25,4	80	1600	1	134,88
MSP110	305	2,20	30	80	1200	1	134,88
MSP111	355	2,20	25,4	90	1200	1	161,67
MSP112	355	2,20	30	90	1200	1	161,67

Aplicação:

Serras circulares para corte de painéis sandwich, ferro, aço, PVC, materiais compostos, etc.

A serra com D=305 e Z=80 é recomendada para corte de aço inoxidável e corte a seco.



METAL DURO

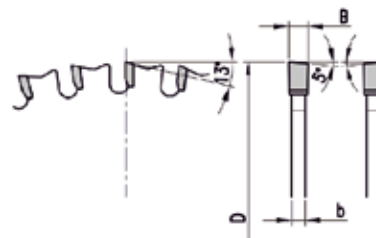

Máquinas Portáteis

CÓDIGO	Ø	Esp.	Furo	Nºdentes	PCS	€
MSP120	160	2,60	20	24	1	37,32
MSP121	160	2,40	16	48	1	53,01
MSP122	160	2,20	20	48	1	56,07
MSP123	180	2,80	30	30	1	44,83
MSP124	190	2,40	30	24	1	40,43
MSP125	190	2,40	30	40	1	65,08
MSP127	210	2,60	30	24	1	40,86
MSP128	210	2,60	30	48	1	57,58
MSP129	230	3,00	30	24	1	44,26
MSP130	230	3,00	30	34	1	51,30
MSP131	235	3,00	30	34	1	51,30
MSP132	235	3,00	30	48	1	61,95

Aplicação:

Serras circulares para corte longitudinal e transversal de madeira maciça e derivados.

Utilização para máquinas:

AEG - BLACK-DECKER - BOSH - HITACHI - KRESS - METABO - ELU - SKIL - FESTO
DEWALT - MAKITA - HAFNER - ELEKTRA - FEIN - RIOBY - PEUGEOT - HOLZ - MAFEL



METAL DURO

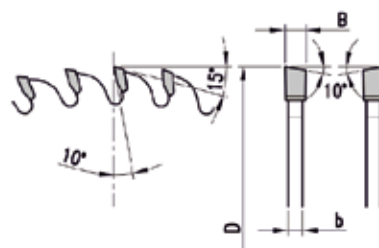

ACCESSORIES/ ACCESSOIRES



ACESSÓRIOS



BUCHAS COM CHAVE PARA BERBEQUINS PORTÁTEIS

DRILL CHUCKS WITH KEY FOR PORTABLE POWER DRILLS
MANDRINS PRÉCISION PERÇEUSES AVEC CLEF



Cone DIN238

CÓDIGO	Capacidade	Cone	PCS	€
MACC013	1 - 10	B 12	1	13,90
MACC015	1 - 13	B 16	1	13,90
MACC012	3 - 16	B 16	1	13,90
MACC014	3 - 16	B 18	1	13,90
MACC016	5 - 20	B 22	1	28,26



Rosca Interior

CÓDIGO	Capacidade	R/UNF	PCS	€
MACC017	1,5 - 10	1/2 × 20	1	11,46
MACC018	1,5 - 10	3/8 × 24	1	11,46
MACC019	1,5 - 13	1/2 × 20	1	13,90
MACC020	1,5 - 13	3/8 × 24	1	13,90

BUCHAS DE APERTO RÁPIDO TIPO STANDARD P/ BERBEQUINS PORTÁTEIS

PROFESSIONAL PRECISION KEYLESS DRILL CHUCKS
MANDRINS PRÉCISION PERÇEUSES PORTABLES



Cone DIN238

CÓDIGO	Capacidade	Cone	PCS	€
MAAR001	0,5 - 6	B 10	1	26,96
MAAR002	1 - 10	B 12	1	26,96
MAAR003	1 - 13	B 16	1	25,56
MAAR004	3 - 16	B 16	1	34,31
MAAR005	3 - 16	B 18	1	34,31



Rosca Interior

CÓDIGO	Capacidade	R/UNF	PCS	€
MAAR006	0,5 - 6	3/8 × 24	1	22,06
MAAR007	1 - 10	3/8 × 24	1	22,06
MAAR011	1 - 10	1/2 × 20	1	22,06
MAAR008	1 - 13	1/2 × 20	1	25,56
MAAR012	1 - 13	3/8 × 24	1	25,56
MAAR009	3 - 16	1/2 × 20	1	33,54
MAAR010	3 - 16	5/8 × 16	1	33,54

BUCHAS DE AP. RÁPIDO DE PRECISÃO P/ BERBEQUINS FIXOS E PORTÁTEIS

PROFESSIONAL PRECISION KEYLESS DRILL CHUCKS
MANDRINS PRÉCISION PERÇEUSES PORTABLES ET FIXES



Profissionais - Rosca Interior

CÓDIGO	Capacidade	R/UNF	PCS	€
MAAR015	1 - 13	1/2 × 20	1	43,88
MAAR016	1 - 13	3/8 × 24	1	43,88

Até fim de existências



Profissionais - Cone DIN238

CÓDIGO	Capacidade	Cone	PCS	€
MAAR013	1 - 16	B 16	1	49,73
MAAR014	1 - 16	B 18	1	49,73

BUCHAS DE APERTO RÁPIDO CAIXA PLÁSTICA P/ BERBEQUINS PORTÁTEIS

PLASTIC KEYLESS DRILL CHUCKS FOR PORTABLE POWER DRILLS
MANDRINS PERÇEUSES PORTABLES EN PLASTIQUE

Buchas Sem Chave para Berbequins Portáteis Profissionais

CÓDIGO	Capacidade	R/UNF	PCS	€
MACP011	0,8 - 10	1/2 × 20	1	18,07
MACP012	0,8 - 10	3/8 × 24	1	18,07
MACP013	2 - 13	1/2 × 20	1	23,11
MACP014	2 - 13	3/8 × 24	1	23,11

Buchas de Aperto com Sistema de Segurança

CÓDIGO	Capacidade	R/UNF	PCS	€
MACP017	2 - 13	1/2 × 20	1	25,43
MACP018	2 - 13	3/8 × 24	1	25,43

Acessório de Bucha 90°

CÓDIGO	Ø	L mm	l mm	€
BM2070	1,5 - 10	155	100	61,81

Chaves

CÓDIGO	Medida	D	PCS	€
MACH030	S1	4 mm	1	1,36
MACH031	S2-R	6 mm	1	1,78
MACH032	S2	6 mm	1	2,85
MACH033	S3	8 mm	1	3,06
MACH034	S4	9 mm	1	3,90

Adaptadores

CÓDIGO	Capacidade	PCS	€
MAAB010	SDS 1/2 × 20 UNF	1	3,85

Caixa Plástica



Caixa Plástica

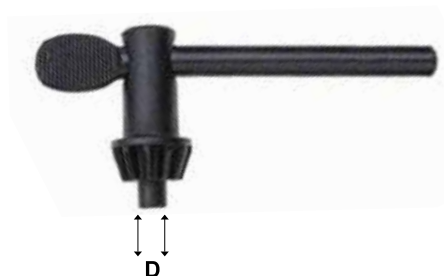
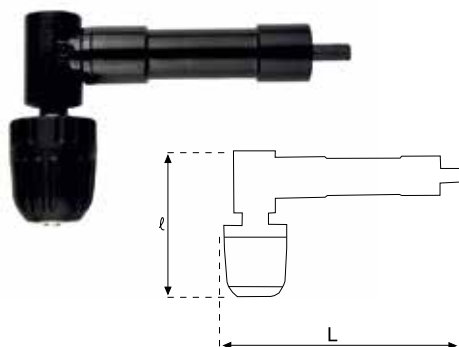

PONTO ROTATIVO STANDARD

REVOLVING TAILSTOCK CENTRES
POINTE TOURNANTE DE PRÉCISION

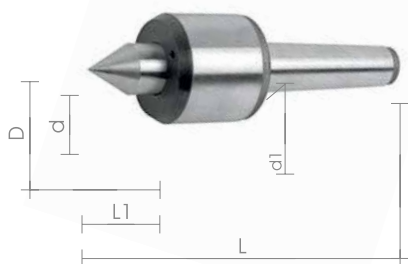

CÓDIGO	Ø	d	d1	D	L1	L	R.P.M. Velocidade Máxima	PCS	€
MUPR001	2	25	17,780	45	28,6	129,6	3.000	1	87,30
MUPR002	3	28	23,825	52	32	160,2	2.800	1	111,88
MUPR003	4	32	31,267	60	36,5	191,7	2.800	1	115,36
MUPR004	5	45	44,399	80	50,8	244,5	2.500	1	180,53

- Corpo e parte giratória temperados e retificados.
- Aplicável a tornos de alta velocidade.

BUCHAS PARA TORNO EM FERRO FUNDIDO DIN6350

LATHE CHUCKS IN CAST IRON
MANDRINS DE TOUR À 3 ET 4 MORS DIN6350



3 Grampos

CÓDIGO	Ø	PCS	€
MUBT01	100	1	318,53
MUBT02	125	1	351,48
MUBT03	160	1	428,38
MUBT04	200	1	531,63
MUBT05	250	1	701,66
MUBT06	315	1	1116,29

- Corpo em ferro fundido.
- Grampos em aço temperado.



4 Grampos

CÓDIGO	Ø	PCS	€
MUBT16	125	1	392,03
MUBT17	160	1	492,53
MUBT18	200	1	617,80
MUBT19	250	1	859,36
MUBT20	315	1	1260,99

- Corpo em ferro fundido.
- Grampos em aço temperado.

GRAMPOS EM AÇO TEMPERADO PARA BUCHAS DIN6350

ACCESSORIES FOR LATHE CHUCKS
MORS POUR MANDRINS DE TOUR



3 Grampos - Interior

CÓDIGO	Ø	PCS	€
MUGI301	100	1	75,34
MUGI302	125	1	83,45
MUGI303	160	1	99,75
MUGI304	200	1	128,26
MUGI305	250	1	150,65
MUGI306	315	1	205,62

- Grampos em aço temperado.



3 Grampos - Exterior

CÓDIGO	Ø	PCS	€
MUGE310	100	1	75,34
MUGE311	125	1	83,45
MUGE312	160	1	99,75
MUGE313	200	1	128,26
MUGE314	250	1	150,65
MUGE315	315	1	205,62

- Grampos em aço temperado.



4 Grampos - Interior

CÓDIGO	Ø	PCS	€
MUGI401	125	1	109,94
MUGI402	160	1	132,33
MUGI403	200	1	168,98
MUGI404	250	1	199,53
MUGI405	315	1	272,83

- Grampos em aço temperado.



4 Grampos - Exterior

CÓDIGO	Ø	PCS	€
MUGE410	125	1	109,94
MUGE411	160	1	132,33
MUGE412	200	1	168,98
MUGE413	250	1	199,53
MUGE414	315	1	272,83

- Grampos em aço temperado.

CONES DE REDUÇÃO E ENCABADOUROS RETIFICADOS

REDUCTION MORSE TAPER SLEEVES AND TAPER DRILL CHUCK ARBORS

DOUILLES DE REDUCTION ET CÔNE DE MONTAGE POUR MANDRINS

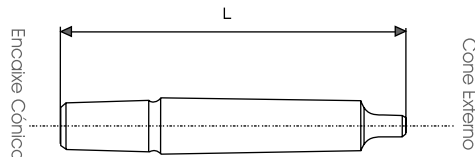
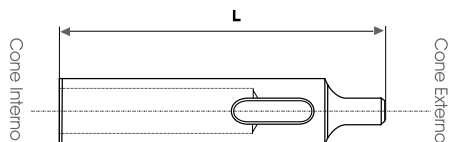

Cones de Redução DIN2185

CÓDIGO	Cone Morse Externo / Interno	L	PCS	€
MER001	2 - 1	92	1	7,17
MER002	3 - 1	99	1	11,18
MER003	3 - 2	112	1	10,30
MER004	4 - 1	124	1	17,29
MER005	4 - 2	124	1	16,07
MER006	4 - 3	140	1	15,55
MER012	5 - 1	156	1	34,42
MER007	5 - 2	156	1	34,42
MER008	5 - 3	156	1	35,47
MER009	5 - 4	171	1	33,72
MER010	6 - 4	218	1	78,80
MER011	6 - 5	218	1	76,35

Encabadouros para Buchas DIN228/238

CÓDIGO	Cone Morse	Encaixe Cônico	L	PCS	€
MEB20	CM1	B 10	86	1	6,94
MEB21	CM1	B 12	89	1	6,94
MEB22	CM1	B 16	99	1	6,94
MEB33	CM2	B 10	105	1	8,74
MEB23	CM2	B 12	105	1	5,94
MEB24	CM2	B 16	112	1	5,94
MEB25	CM2	B 18	119	1	6,29
MEB34	CM2	B 22	130	1	8,74
MEB26	CM3	B 12	127	1	7,86
MEB27	CM3	B 16	134	1	7,88
MEB28	CM3	B 18	140	1	8,21
MEB29	CM3	B 22	147	1	8,21
MEB30	CM4	B 16	157	1	17,29
MEB31	CM4	B 18	164	1	17,65
MEB32	CM4	B 22	176	1	18,69
MEB35	CM5	B 16	198	1	37,56
MEB36	CM5	B 18	198	1	38,96
MEB37	CM5	B 22	207	1	40,53
MEB38	CM5	B 24	217	1	42,28

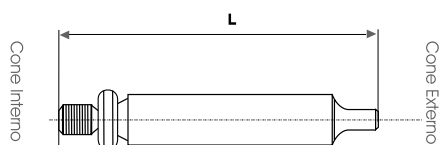

Encabadouros Roscados DIN228

CÓDIGO	Cone Morse	R/UNF	L	PCS	€
MEB80	CM2	3/8 x 24	95	1	17,63
MEB81	CM2	1/2 x 20	110	1	17,63
MEB82	CM2	5/8 x 16	135	1	21,90
MEB83	CM3	3/8 x 24	115	1	24,23
MEB84	CM3	1/2 x 20	125	1	24,23
MEB85	CM3	5/8 x 16	150	1	24,23

PINÇAS DE PRECISÃO ER16, ER25

COLLET CHUCKS ER16, ER25

PINCES DE PRÉCISION ER16, ER25

D2:17 L1:27,5 $\alpha:8^\circ$ $\beta:30^\circ$

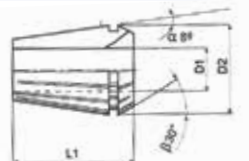

Pinças de Precisão ER16 - DIN6499-B

CÓDIGO		Capacidade	D1	PCS	€
MP8000	ER16	1,0	0,5	1	24,70
MP8001	ER16	1,5	1,0	1	24,70
MP8002	ER16	2,0	1,0	1	24,70
MP8003	ER16	2,5	2,0	1	24,70
MP8004	ER16	3,0	2,0	1	24,70
MP8005	ER16	3,5	3,0	1	20,62
MP8006	ER16	4,0	3,0	1	20,62
MP8007	ER16	4,5	3,0	1	20,62
MP8008	ER16	5,0	4,0	1	20,62
MP8009	ER16	6,0	5,0	1	20,62
MP8010	ER16	7,0	6,0	1	20,62
MP8011	ER16	8,0	7,0	1	20,62
MP8012	ER16	9,0	8,0	1	20,62
MP8013	ER16	10,0	9,0	1	20,62

Outras medidas sob consulta

D2:26 L1:34 $\alpha:8^\circ$ $\beta:30^\circ$

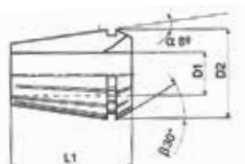

Pinças de Precisão ER25 - DIN6499-B

CÓDIGO		Capacidade	D1	PCS	€
MP8050	ER25	1,0	0,5	1	26,79
MP8051	ER25	2,0	1,5	1	26,79
MP8052	ER25	3,0	2,0	1	20,62
MP8053	ER25	4,0	3,0	1	20,62
MP8054	ER25	5,0	4,0	1	20,62
MP8055	ER25	6,0	5,0	1	20,62
MP8056	ER25	7,0	6,0	1	20,62
MP8057	ER25	8,0	7,0	1	20,62
MP8058	ER25	9,0	8,0	1	20,62
MP8059	ER25	10,0	9,0	1	20,62
MP8060	ER25	11,0	10,0	1	20,62
MP8061	ER25	12,0	11,0	1	20,62
MP8062	ER25	13,0	12,0	1	20,62
MP8063	ER25	14,0	13,0	1	20,62
MP8064	ER25	15,0	14,0	1	20,62
MP8065	ER25	16,0	15,0	1	20,62

Outras medidas sob consulta

PINÇAS DE PRECISÃO ER32, ER40

COLLET CHUCKS ER32, ER40

PINCES DE PRÉCISION ER32, ER40



D2:33 L1:40 $\alpha:8^\circ$ $\beta:30^\circ$

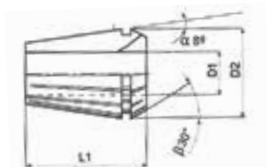

D2:41 L1:46 $\alpha:8^\circ$ $\beta:30^\circ$

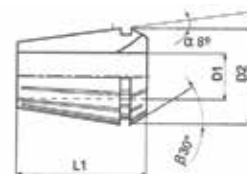

Pinças de Precisão ER32 - DIN6499-B

CÓDIGO	Capacidade	D1	PCS	€
MP8119	ER32	2,0	1,5	1 18,52
MP8120	ER32	3,0	2,5	1 18,52
MP8102	ER32	4,0	3,0	1 18,52
MP8103	ER32	5,0	4,0	1 18,52
MP8104	ER32	6,0	5,0	1 18,52
MP8105	ER32	7,0	6,0	1 18,52
MP8106	ER32	8,0	7,0	1 18,52
MP8107	ER32	9,0	8,0	1 18,52
MP8108	ER32	10,0	9,0	1 18,52
MP8109	ER32	11,0	10,0	1 18,52
MP8110	ER32	12,0	11,0	1 18,52
MP8111	ER32	13,0	12,0	1 18,52
MP8112	ER32	14,0	13,0	1 18,52
MP8113	ER32	15,0	14,0	1 18,52
MP8114	ER32	16,0	15,0	1 18,52
MP8115	ER32	17,0	16,0	1 18,52
MP8116	ER32	18,0	17,0	1 18,52
MP8117	ER32	19,0	18,0	1 18,52
MP8118	ER32	20,0	19,0	1 18,52

Outras medidas sob consulta

Pinças de Precisão ER40 - DIN6499-B

CÓDIGO	Capacidade	D1	PCS	€
MP8150	ER40	3,0	2,0	1 26,62
MP8151	ER40	4,0	3,0	1 26,62
MP8152	ER40	5,0	4,0	1 26,62
MP8153	ER40	6,0	5,0	1 26,62
MP8154	ER40	7,0	6,0	1 26,62
MP8155	ER40	8,0	7,0	1 26,62
MP8156	ER40	9,0	8,0	1 26,62
MP8157	ER40	10,0	9,0	1 26,62
MP8158	ER40	11,0	10,0	1 26,62
MP8159	ER40	12,0	11,0	1 26,62
MP8160	ER40	13,0	12,0	1 26,62
MP8161	ER40	14,0	13,0	1 26,62
MP8162	ER40	15,0	14,0	1 26,62
MP8163	ER40	16,0	15,0	1 26,62
MP8164	ER40	17,0	16,0	1 26,62
MP8165	ER40	18,0	17,0	1 26,62
MP8166	ER40	19,0	18,0	1 26,62
MP8167	ER40	20,0	19,0	1 26,62
MP8168	ER40	21,0	20,0	1 26,62
MP8169	ER40	22,0	21,0	1 26,62
MP8170	ER40	23,0	22,0	1 26,62
MP8171	ER40	24,0	23,0	1 26,62
MP8172	ER40	25,0	24,0	1 26,62
MP8173	ER40	26,0	25,0	1 40,13
MP8174	ER40	27,0	26,0	1 40,13
MP8175	ER40	28,0	27,0	1 40,13
MP8176	ER40	29,0	28,0	1 40,13
MP8177	ER40	30,0	29,0	1 40,13

Outras medidas sob consulta

JOGOS DE PINÇAS DE PRECISÃO

COLLET CHUCKS SETS

JEUX PINCES DE PRÉCISION



Jogo ER16 de 1 a 10	
Composição 10 peças	
CÓDIGO	€
MP8200	154,35



Jogo ER25 de 2 a 16	
Composição 15 peças	
CÓDIGO	€
MP8201	241,18



Jogo ER32 de 3 a 20	
Composição 18 peças	
CÓDIGO	€
MP8202	308,70



Jogo ER40 de 4 a 26	
Composição 24 peças	
CÓDIGO	€
MP8204	474,63

CONES PARA PINÇAS DE PRECISÃO - ER16, ER25, ER32, ER40

COLLET CHUCKS ER16, ER25, ER32, ER40
PORTE-PINCES DE HAUTE PRÉCISION

SK40

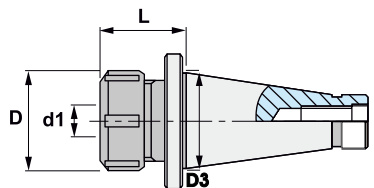

Cones SK40 para Pinças de Precisão - DIN69871

CÓDIGO	Pinça DIN6499	L	d1	D	D3	PCS	€
MP8510	ER16	63	0,5-10	32		1	108,27
MP8511	ER 16	100	0,5-10	32	28	1	121,33
MP8512	ER25	60	1-16	42		1	108,27
MP8513	ER25	100	1-16	42	45	1	136,27
MP8514	ER32	70	2-20	50		1	119,47
MP8515	ER32	100	2-20	50	48	1	136,27
MP8516	ER40	80	3-30	63		1	125,07
MP8517	ER40	100	3-30	63	50	1	154,93

Outras medidas sob consulta

BT40

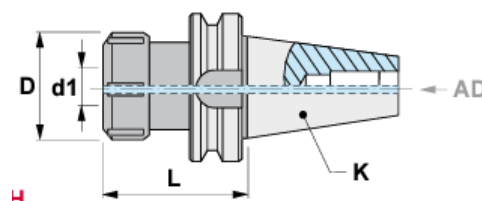

Cones BT40 para Pinças de Precisão - B6339 MAS403

CÓDIGO	Pinça DIN6499	L	d1	D	PCS	€
MP8555	ER16	63	0,5-10	32	1	115,73
MP8556	ER25	60	1-16	42	1	115,73
MP8557	ER32	70	2-20	50	1	119,47
MP8558	ER40	80	3-30	63	1	125,07

Outras medidas sob consulta

MK

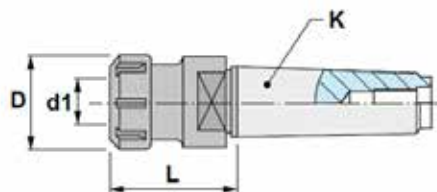

MK para Pinças de Precisão - DIN228

CÓDIGO	Pinça DIN6499	K	L	d1	D	PCS	€
MP8560	ER32	3	74	2-20	50	1	168,00
MP8561	ER40	3	85	4-30	63	1	214,67
MP8562	ER32	4	84	2-20	50	1	196,00
MP8563	ER40	4	80	4-30	63	1	233,33

Outras medidas sob consulta

SACA BOCADOS PARA UTILIZAÇÃO COM CHAVE

STANDARD BALL BEARING PUNCHES

EMPORTE PIECES STANDARD



Para furos precisos em chapa de aço inoxidável e materiais plásticos

Rosca Métrica HSS

CÓDIGO	Medida	S	PCS	€
MRS001	10	1,5	1	62,54
MRS002	11	1,5	1	62,54
MRS003	12	1,5	1	62,54
MRS004	12,5 Pg 7/M 12×1,5	1,5	1	62,54
MRS005	13	1,5	1	62,54
MRS006	14	1,5	1	70,05
MRS007	15	1,5	1	70,05
MRS008	15,2 Pg 9	1,5	1	70,05
MRS009	16	2	1	51,48
MRS010	16,5 M 16×1,5	2	1	51,48
MRS011	17	2	1	51,48
MRS012	18	2	1	51,48
MRS013	18,6 Pg 11	2	1	54,76
MRS014	19	2	1	54,76
MRS015	20	2	1	54,76
MRS016	20,5 Pg 13,5/M 20×1,5	2	1	54,76
MRS017	21	2	1	54,76
MRS018	22	2	1	57,98
MRS019	22,5 Pg 16	2	1	57,98
MRS020	23	2	1	57,98
MRS021	24	2	1	57,98
MRS022	25	2	1	64,41
MRS023	25,5 M 25×1,5	2	1	64,41
MRS024	26	2	1	64,41
MRS025	27	2	1	64,41
MRS026	28	2	1	67,71
MRS027	28,3 Pg 21	2	1	67,71
MRS028	29	2	1	67,71
MRS029	30	2	1	67,71
MRS030	30,5	2	1	69,37
MRS031	32	2	1	69,37
MRS032	32,5 M 32×1,5	2	1	75,62
MRS033	33	2	1	75,62
MRS034	34	2	1	75,62
MRS035	35	2	1	75,62
MRS036	36	2	1	82,16
MRS037	37 Pg 29	2	1	82,16

CÓDIGO	Medida	S	PCS	€
MRS038	38	1,5	1	82,16
MRS039	39	1,5	1	99,52
MRS040	40	1,5	1	99,52
MRS041	40,5 M 40×1,5	1,5	1	99,52
MRS042	41	1,5	1	99,52
MRS043	42	1,5	1	108,65
MRS044	43	1,5	1	108,65
MRS045	44	1,5	1	108,65
MRS046	45	2	1	116,17
MRS047	46	2	1	116,17
MRS048	47 Pg 36	2	1	116,17
MRS049	48	2	1	125,85
MRS050	50	2	1	125,85
MRS051	50,5 M 50×1,5	2	1	137,71
MRS052	51	2	1	137,71
MRS053	52	2	1	137,71
MRS054	52,5	2	1	203,32
MRS055	54 Pg 42	2	1	147,37
MRS056	55	2	1	147,37
MRS057	57	2	1	157,06
MRS058	58	2	1	157,06
MRS059	59	2	1	157,06
MRS060	60 Pg 48	2	1	171,05
MRS061	60,5	2	1	252,81
MRS062	61	2	1	171,05
MRS063	62	2	1	171,05
MRS064	63	2	1	208,69
MRS065	63,5 M 63×1,5	2	1	208,16
MRS066	64	2	1	208,69
MRS067	65	2	1	208,69
MRS068	70	2	1	262,48
MRS069	73	2	1	307,66
MRS070	75	2	1	250,96
MRS071	80	2	1	366,84
MRS072	85	2	1	526,03
MRS073	89	2	1	534,64
MRS074	102	2	1	748,70

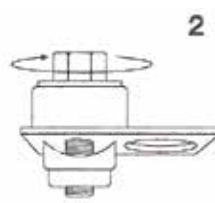
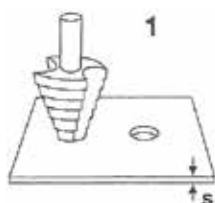

JOGOS DE SACA BOCADOS PARA UTILIZAÇÃO COM CHAVE

STANDARD BALL BEARING PUNCHES SETS

JEUX DE EMPORTE PIECES STANDARD



Utilização com Chave

Jogo Pg 7 - Pg 29

Composição 7 peças

Ø 12,5 - 15,2 - 18,6 - 20,5 - 22,5 - 28,3 - 37

CÓDIGO	€
MRS100	566,24



Utilização com Chave

Jogo Pg 7 - Pg 48

Composição 11 peças

Ø 12,5 - 15,2 - 18,6 - 20,5 - 22,5 - 28,3 - 37
47 - 54 - 60

 7 a 21mm

CÓDIGO	€
MRS102	919,76

Jogo M 12 x 1,5 - M 63 x 1,5

Composição 9 peças

Ø 12,5 - 16,5 - 20,5 - 25,5 - 32,5 - 40,5
50,5 - 63,5

CÓDIGO	€
MRS103	783,86

PARAFUSOS COM ANILHAS PARA SACA BOCADOS

DRAW STUD

VIS POUR EMPORTE-PIÈCE



CÓDIGO	Medida	Capacidade	PCS	€
MRS210	M 6 x 1	10 - 13	1	14,72
MRS211	M 8 x 1	14 - 15,2	1	14,72
MRS212	M 10 x 1	16 - 38	1	16,56
MRS213	M 12 x 1,5	39 - 50	1	18,41
MRS214	M 16 x 1,5	51 - 62	1	23,92

BITS

BITS
EMBOUTS



Chave de Caixa Hexagonal Magnética

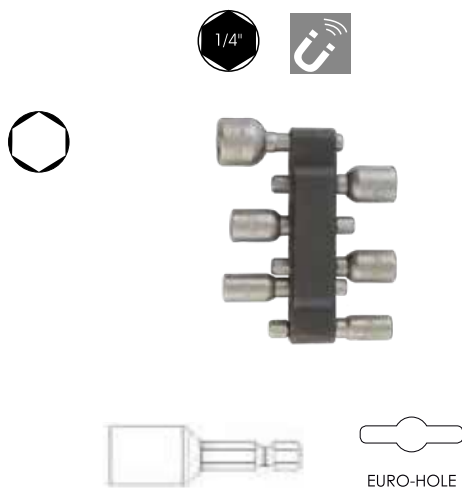

CÓDIGO	Ø mm	L mm	PCS	€ *
BM0778	5,5	45	5	1,68
BM0779	6	45	5	1,68
BM0780	8	45	5	3,21
BM0781	10	45	5	3,21
BM0782	8	65	5	5,70
BM0783	10	65	5	5,70
BM0784	7	50	5	3,21
BM0785	11	45	5	3,21
BM0786	12	45	5	3,21
BM0787	13	45	5	3,21

*Valor Unidade

Jogo de chaves sextavadas Magnéticas	
Composição 6 Peças	
Ø	UN
5,5	1
6	1
7	1
8	1
10	1
13	1
CÓDIGO	€
BM0790	18,69

Hexagonal

PONTA DE 1/4" HEXAGONAL

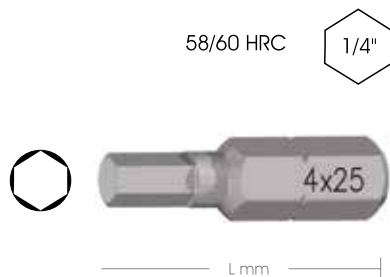

CÓDIGO	Ø	L mm	PCS	€ *
BM0001	1,5	25	10	0,68
BM0002	2	25	10	0,68
BM0003	2,5	25	10	0,68
BM0004	3	25	10	0,68
BM0005	4	25	10	0,68
BM0006	5	25	10	0,68
BM0007	6	25	10	0,68
BM0008	7	25	10	1,34
BM0009	8	25	10	1,34
BM0010	10	25	10	1,34

*Valor Unidade

BITS

BITS
EMBOUTS

PH Fresado

PONTA DE 1/4" PHILLIPS

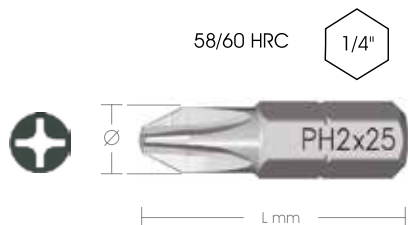

CÓDIGO	+	ø mm	L mm	PCS	€*
BM0101	PH0	3	25	10	0,50
BM0102	PH1	4,5	25	10	0,50
BM0103	PH2	6	25	10	0,50
BM0104	PH3	6	25	10	0,50
BM0106	PH4	10	32	10	1,72

*Valor Unidade

PH Fresado Longo

PONTA DE 1/4" PHILLIPS LONGO

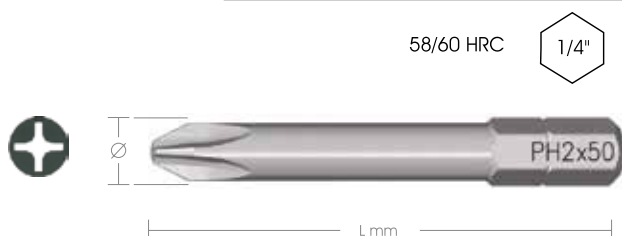

CÓDIGO	+	ø mm	L mm	PCS	€*
BM0120	PH1	4,5	50	5	0,95
BM0121	PH2	6	50	5	0,95
BM0122	PH3	8	50	5	0,95

*Valor Unidade

PH Fresado Longo e Extra Longo

PONTA DE 1/4" PHILLIPS LONGO E EXTRA LONGO

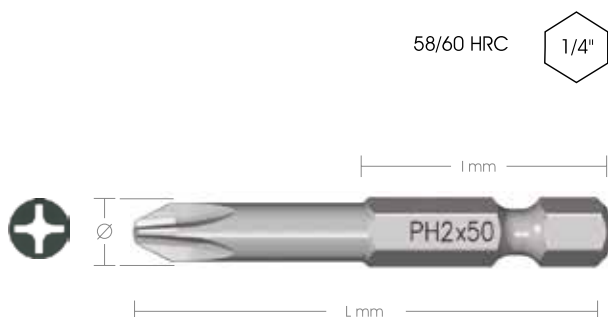

CÓDIGO	+	ø mm	L mm	l mm	PCS	€*
BM0500	PH0	3	50	25	5	0,95
BM0501	PH0	3	75	25	5	1,88
BM0502	PH0	3	100	25	5	2,63
BM0503	PH1	4,5	50	25	5	0,95
BM0504	PH1	4,5	70	25	5	2,08
BM0505	PH1	4,5	75	25	5	2,04
BM0506	PH1	4,5	90	25	5	2,32
BM0507	PH1	4,5	100	25	5	2,52
BM0508	PH1	4,5	127	25	5	3,42
BM0509	PH1	4,5	150	25	5	4,54
BM0510	PH1	4,5	200	25	5	6,29
BM0511	PH2	6	50	25	5	0,95
BM0512	PH2	6	70	25	5	1,88
BM0513	PH2	6	75	25	5	2,04
BM0514	PH2	6	90	25	5	2,32
BM0515	PH2	6	100	25	5	2,52
BM0516	PH2	6	120	25	5	3,30
BM0517	PH2	6	127	25	5	3,42
BM0518	PH2	6	150	25	5	4,61
BM0519	PH2	6	200	25	5	6,29
BM0520	PH3	6	50	25	5	0,95
BM0521	PH3	8	50	25	5	1,40
BM0522	PH3	6	75	25	5	2,04
BM0523	PH3	8	75	25	5	2,97
BM0524	PH3	6	100	25	5	2,52
BM0525	PH3	8	100	25	5	3,84
BM0526	PH3	8	150	25	5	6,93
BM0527	PH4	10	50	25	5	2,37

*Valor Unidade

BITS

BITS
EMBOUTS

PH Torção +

PONTA DE 1/4" PHILLIPS - EXTRA DURO, RESISTENTE A ELEVADA TORÇÃO

60/62 HRC



L mm

CÓDIGO		L mm	PCS	€*
BM0183	PH1	25	10	1,19
BM0184	PH2	25	10	1,19
BM0185	PH3	25	10	1,19

*Valor Unidade

PH Torção + Longo

PONTA DE 1/4" PHILLIPS LONGO - EXTRA DURO, RESISTENTE A ELEVADA TORÇÃO

60/62 HRC



L mm

CÓDIGO		L mm	PCS	€*
BM0186	PH1	50	5	2,24
BM0187	PH2	50	5	2,24
BM0188	PH3	50	5	2,24

*Valor Unidade

PH Torção TM

PONTA DE 1/4" PHILLIPS - TENAZES RESISTENTES A ELEVADA TORÇÃO

58/60 HRC



L mm

CÓDIGO		L mm	PCS	€*
BM0170	PH1	25	5	0,62
BM0171	PH2	25	5	0,62
BM0172	PH3	25	5	0,62

*Valor Unidade

PH Torção TM Longo

PONTA DE 1/4" PHILLIPS - TENAZES RESISTENTES A ELEVADA TORÇÃO

58/60 HRC



L mm

CÓDIGO		L mm	PCS	€*
BM0176	PH1	50	5	1,47
BM0177	PH2	50	5	1,47
BM0178	PH3	50	5	1,47

*Valor Unidade

BITS

BITS
EMBOUS

PH Titânio

PONTA DE 1/4" PHILLIPS - REVISTIDA A TITÂNIO

59/60 HRC

1/4"



CÓDIGO	+	ø mm	L mm	PCS	€*
BM0180	PH1	4,5	25	10	1,47
BM0181	PH2	4,5	25	10	1,47
BM0179	PH2	6	25	10	1,47
BM0182	PH3	6	25	10	1,47

*Valor Unidade

PH Titânio Longo

PONTA DE 1/4" PHILLIPS LONGO - REVISTIDA A TITÂNIO

59/60 HRC

1/4"



CÓDIGO	+	ø mm	L mm	PCS	€*
BM0190	PH1	4,5	50	5	2,66
BM0191	PH2	6	50	5	2,66
BM0192	PH3	6	50	5	2,66

*Valor Unidade

PH Impacto

PONTA DE 1/4" PHILLIPS LONGO - PARA MÁQUINAS DE IMPACTO

58/60 HRC

1/4"



CÓDIGO	+	L mm	PCS	€*
BM0600	PH1	30	10	1,88
BM0601	PH2	30	10	1,88
BM0602	PH3	30	10	1,88

*Valor Unidade

PH Impacto Longo

PONTA DE 1/4" PHILLIPS LONGO - PARA MÁQUINAS DE IMPACTO

58/60 HRC

1/4"



CÓDIGO	+	L mm	PCS	€*
BM0610	PH1	50	5	3,30
BM0611	PH2	50	5	3,30
BM0612	PH3	50	5	3,30

*Valor Unidade

BITS

BITS
EMBOUTS

PH HDC

PONTA DE 1/4" PHILLIPS - REVISTIDA A DIAMANTE

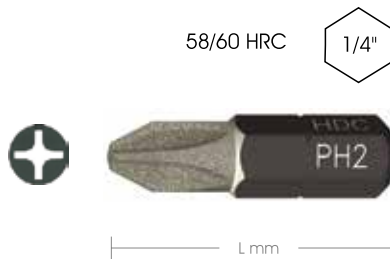

CÓDIGO		L mm	PCS	€*
BM0620	PH1	25	10	2,32
BM0621	PH2	25	10	2,32
BM0622	PH2	25	10	2,32

*Valor Unidade

PH HDC Longo

PONTA DE 1/4" PHILLIPS LONGO - REVISTIDA A DIAMANTE



CÓDIGO		L mm	PCS	€*
BM0630	PH1	50	5	4,33
BM0631	PH2	50	5	4,33
BM0632	PH3	50	5	4,33

*Valor Unidade

BITS

BITS
EMBOUTS

PZ Fresado

PONTA DE 1/4" POZIDRIVE COM PONTA FRESADA

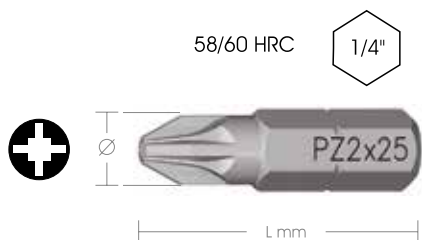

CÓDIGO	+	ø mm	L mm	PCS	€*
BM0201	PZ0	3	25	10	0,50
BM0202	PZ1	4,5	25	10	0,50
BM0203	PZ2	6	25	10	0,50
BM0204	PZ3	6	25	10	0,50
BM0205	PZ4	10	32	10	1,72

*Valor Unidade

PZ Fresado Longo

PONTA DE 1/4" POZIDRIVE LONGO COM PONTA FRESADA

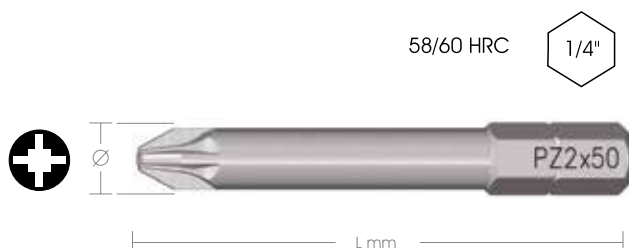

CÓDIGO	+	ø mm	L mm	PCS	€*
BM0220	PZ1	4,5	50	5	1,61
BM0221	PZ2	6	50	5	1,61
BM0222	PZ3	8	50	5	2,69

*Valor Unidade

PZ Fresado Longo e Extra Longo

PONTA DE 1/4" POZIDRIVE LONGO E EXTRA LONGO COM PONTA FRESADA

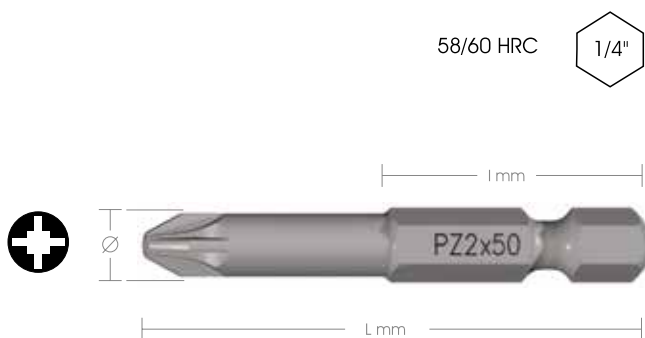

CÓDIGO	+	ø mm	L mm	l mm	PCS	€*
BM0550	PZ0	3	50	25	5	0,95
BM0551	PZ1	4,5	50	25	5	0,95
BM0552	PZ1	4,5	70	25	5	1,88
BM0553	PZ1	4,5	75	25	5	2,04
BM0554	PZ1	4,5	90	25	5	2,32
BM0555	PZ1	4,5	100	25	5	2,52
BM0556	PZ1	4,5	127	25	5	3,42
BM0557	PZ1	4,5	150	25	5	4,61
BM0558	PZ1	4,5	200	25	5	6,29
BM0559	PZ2	6	50	25	5	0,95
BM0560	PZ2	6	70	25	5	1,88
BM0561	PZ2	6	75	25	5	2,04
BM0562	PZ2	6	90	25	5	2,32
BM0563	PZ2	6	100	25	5	2,52
BM0564	PZ2	6	127	25	5	3,42
BM0565	PZ2	6	150	25	5	4,61
BM0566	PZ2	6	200	25	5	6,29
BM0567	PZ3	6	50	25	5	0,95
BM0568	PZ3	8	50	25	5	1,40
BM0569	PZ3	6	75	25	5	2,04
BM0570	PZ3	8	75	25	5	2,97
BM0571	PZ3	6	100	25	5	2,52
BM0572	PZ3	8	100	25	5	3,84
BM0573	PZ3	8	150	25	5	6,93
BM0574	PZ4	10	50	25	5	2,37

*Valor Unidade

BITS

BITS
EMBOUTS

PZ Torção +

PONTA DE 1/4" POZIDRIVE - EXTRA DURO, RESISTENTE A ELEVADA TORÇÃO



CÓDIGO		L mm	PCS	€*
BM0293	PZ1	25	10	1,19
BM0294	PZ2	25	10	1,19
BM0295	PZ3	25	10	1,19

*Valor Unidade

PZ Torção + Longo

PONTA DE 1/4" POZIDRIVE LONGO - EXTRA DURO, RESISTENTE A ELEVADA TORÇÃO



CÓDIGO		L mm	PCS	€*
BM0296	PZ1	50	5	2,24
BM0297	PZ2	50	5	2,24
BM0298	PZ3	50	5	2,24

*Valor Unidade

PZ Torção TM

PONTA DE 1/4" POZIDRIVE - TENAZES RESISTENTES A ELEVADA TORÇÃO



CÓDIGO		L mm	PCS	€*
BM0270	PZ1	25	10	0,62
BM0271	PZ2	25	10	0,62
BM0272	PZ3	25	10	0,62

*Valor Unidade

PZ Torção TM Longo

PONTA DE 1/4" POZIDRIVE LONGO - TENAZES RESISTENTES A ELEVADA TORÇÃO



CÓDIGO		L mm	PCS	€*
BM0280	PZ1	50	5	1,47
BM0281	PZ2	50	5	1,47
BM0283	PZ3	50	5	1,47

*Valor Unidade

BITS

BITS
EMBOUTS

PZ Titânio

PONTA DE 1/4" POZIDRIVE - REVESTIDA A TITÂNIO



CÓDIGO	+	Ø mm	L mm	PCS	€*
BM0287	PZ1	4,5	25	10	1,47
BM0286	PZ2	6	25	10	1,47
BM0289	PZ3	6	25	10	1,47

*Valor Unidade

PZ Titânio Longo

PONTA DE 1/4" POZIDRIVE LONGO - REVESTIDA A TITÂNIO



CÓDIGO	+	Ø mm	L mm	PCS	€*
BM0196	PZ2	6	50	5	2,66

*Valor Unidade

PZ Impacto

PONTA DE 1/4" POZIDRIVE LONGO - PARA MÁQUINAS DE IMPACTO



CÓDIGO	+	L mm	PCS	€*
BM0640	PZ1	30	10	1,88
BM0641	PZ2	30	10	1,88
BM0642	PZ3	30	10	1,88

*Valor Unidade

PZ Impacto Longo

PONTA DE 1/4" POZIDRIVE LONGO - PARA MÁQUINAS DE IMPACTO



CÓDIGO	+	L mm	PCS	€*
BM0650	PZ1	50	5	3,30
BM0651	PZ2	50	5	3,30
BM0652	PZ3	50	5	3,30

*Valor Unidade

BITS

BITS
EMBOUTS

PZ HDC

PONTA DE 1/4" POZIDRIVE - REVISTIDA A DIAMANTE



CÓDIGO	+	L mm	PCS	€*
BM0660	PZ1	25	10	2,32
BM0661	PZ2	25	10	2,32
BM0662	PZ3	25	10	2,32

*Valor Unidade

PZ HDC Longo

PONTA DE 1/4" POZIDRIVE LONGO - REVISTIDA A DIAMANTE



CÓDIGO	+	L mm	PCS	€*
BM0670	PZ1	50	5	4,33
BM0671	PZ2	50	5	4,33
BM0672	PZ3	50	5	4,33

*Valor Unidade

BITS

BITS
EMBOUTS

TX

PONTA DE 1/4" POZIDRIVE - REVESTIDA A DIAMANTE



CÓDIGO		L mm	PCS	€*
BM1000	TX06	25	10	0,62
BM1001	TX07	25	10	0,62
BM1002	TX08	25	10	0,62
BM1003	TX09	25	10	0,62
BM1004	TX10	25	10	0,62
BM1005	TX15	25	10	0,62
BM1006	TX20	25	10	0,62
BM1007	TX25	25	10	0,62
BM1008	TX27	25	10	0,62
BM1009	TX30	25	10	0,62
BM1010	TX40	25	10	0,62
BM1011	TX45	25	10	1,26
BM1012	TX50	25	10	1,58

*Valor Unidade

TX Longo

PONTA DE 1/4" POZIDRIVE LONGO - REVESTIDA A DIAMANTE

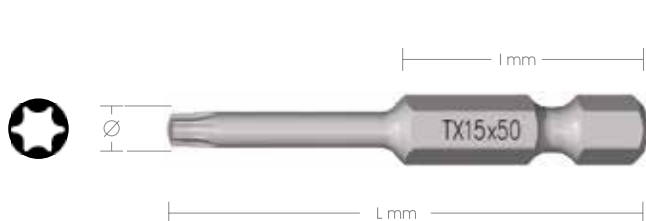

CÓDIGO		Ø mm	L mm	l mm	PCS	€*
BM1126	TX20	4,5	50	25	5	1,11
BM1127	TX20	5	70	25	5	2,04
BM1128	TX20	5	90	25	5	4,49
BM1129	TX20	5	100	25	5	4,68
BM1130	TX20	5	127	25	5	6,36
BM1131	TX20	5	150	25	5	10,13
BM1132	TX20	5	200	25	5	12,52
BM1134	TX25	5	50	25	5	1,11
BM1135	TX25	5	70	25	5	2,04
BM1136	TX25	5	90	25	5	4,49
BM1137	TX25	5	100	25	5	5,98
BM1138	TX25	5	127	25	5	6,36
BM1139	TX25	5	150	25	5	10,13
BM1140	TX25	5	200	25	5	12,52
BM1141	TX27	6	50	25	5	1,11
BM1142	TX27	6	70	25	5	2,04
BM1143	TX27	6	90	25	5	4,49
BM1144	TX27	6	100	25	5	4,68
BM1145	TX27	6	127	25	5	6,93
BM1146	TX30	6	50	25	5	1,11
BM1147	TX30	6	70	25	5	2,04
BM1148	TX30	6	90	25	5	4,49
BM1149	TX30	6	100	25	5	4,68
BM1150	TX30	6	127	25	5	6,36
BM1151	TX30	6	150	25	5	10,13
BM1152	TX40	1/4	50	25	5	1,11
BM1153	TX40	1/4	70	25	5	2,04
BM1154	TX40	1/4	90	25	5	4,49
BM1155	TX40	1/4	100	25	5	4,68
BM1156	TX40	1/4	150	25	5	10,13

*Valor Unidade

*Valor Unidade

BITS

BITS
EMBOUTS

TX Torção TM

PONTA DE 1/4" PARA PARAFUSOS TORX - TENAZES RESISTENTES A ELEVADA TORÇÃO



CÓDIGO		L mm	PCS	€*
BM1020	TX10	25	10	0,85
BM1021	TX15	25	10	0,85
BM1022	TX20	25	10	0,85
BM1023	TX25	25	10	0,85
BM1024	TX27	25	10	0,85
BM1025	TX30	25	10	0,85
BM1026	TX40	25	10	0,85

*Valor Unidade

TX Torção TM Longo

PONTA DE 1/4" PARA PARAFUSOS TORX LONGO - TENAZES RESISTENTES A ELEVADA TORÇÃO



CÓDIGO		L mm	PCS	€*
BM1030	TX10	50	5	3,01
BM1031	TX15	50	5	3,01
BM1032	TX20	50	5	3,01
BM1033	TX25	50	5	3,01
BM1034	TX27	50	5	3,01
BM1035	TX30	50	5	3,01
BM1036	TX40	50	5	3,01

*Valor Unidade

TX Titânio

PONTA DE 1/4" PARA PARAFUSOS TORX - REVESTIDA A TITÂNIO



CÓDIGO		L mm	PCS	€*
BM1050	TX10	25	10	1,83
BM1051	TX15	25	10	1,83
BM1052	TX20	25	10	1,83
BM1053	TX25	25	10	1,83
BM1054	TX27	25	10	1,83
BM1055	TX30	25	10	1,83
BM1056	TX40	25	10	1,83

*Valor Unidade

BITS

BITS
EMBOUTS

TX Impacto

PONTA DE 1/4" PARA PARAFUSOS TORX PARA MÁQUINAS DE IMPACTO



CÓDIGO		L mm	PCS	€*
BM1060	TX10	30	10	2,38
BM1061	TX15	30	10	2,38
BM1062	TX20	30	10	2,38
BM1063	TX25	30	10	2,38
BM1064	TX27	30	10	2,38
BM1065	TX30	30	10	2,38
BM1066	TX40	30	10	2,38

*Valor Unidade

TX Impacto Longo

PONTA DE 1/4" PARA PARAFUSOS TORX LONGO PARA MÁQUINAS DE IMPACTO



CÓDIGO		L mm	PCS	€*
BM1070	TX10	50	5	4,55
BM1071	TX15	50	5	4,55
BM1072	TX20	50	5	4,55
BM1073	TX25	50	5	4,55
BM1074	TX27	50	5	4,55
BM1075	TX30	50	5	4,55
BM1076	TX40	50	5	4,55

*Valor Unidade

TX HDC

PONTA DE 1/4" PARA PARAFUSOS TORX - REVISTIDA A DIAMANTE



CÓDIGO		L mm	PCS	€*
BM1080	TX10	25	10	3,35
BM1081	TX15	25	10	3,35
BM1082	TX20	25	10	3,35
BM1083	TX25	25	10	3,35
BM1084	TX30	25	10	3,35
BM1085	TX40	25	10	3,35

*Valor Unidade

BITS

BITS
EMBOUTS

Fenda

PONTA DE 1/4" DE FENDA

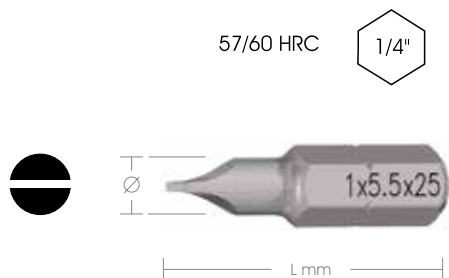

CÓDIGO	Ø mm	L mm	PCS	€*	
BM1200	0,5	3	25	10	0,68
BM1201	0,6	3,5	25	10	0,68
BM1202	0,6	4	25	10	0,68
BM1203	0,6	4,5	25	10	0,68
BM1204	0,8	5	25	10	0,68
BM1205	0,8	5,5	25	10	0,68
BM1206	1	5,5	25	10	0,68
BM1207	1	6	25	10	0,68
BM1208	1,2	6,5	25	10	0,68
BM1209	1,2	8	25	10	1,22
BM1210	1,6	8	25	10	1,22

*Valor Unidade

Fenda Longa e Extra Longa

PONTA DE 1/4" LONGA E EXTRA LONGA DE FENDA

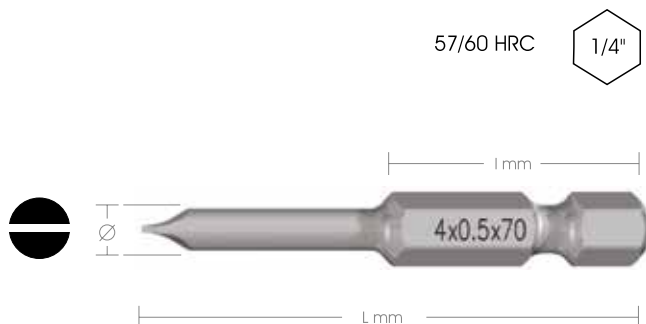

CÓDIGO	Ø mm	L mm	l mm	PCS	€*	
BM1250	0,5	3	50	25	5	1,16
BM1251	0,5	3	70	25	5	2,04
BM1252	0,6	3,5	50	25	5	1,16
BM1253	0,6	3,5	70	25	5	2,04
BM1254	0,5	4	50	25	5	1,16
BM1255	0,5	4	70	25	5	2,04
BM1256	0,5	4	100	25	5	4,48
BM1257	0,6	4,5	50	25	5	1,16
BM1258	0,6	4,5	70	25	5	2,04
BM1259	0,6	4,5	100	25	5	4,48
BM1260	0,8	5	50	25	5	1,16
BM1261	0,8	5	70	25	5	2,04
BM1262	0,8	5	100	25	5	4,48
BM1263	0,8	5,5	50	25	5	1,16
BM1264	0,8	5,5	70	25	5	2,04
BM1265	1	6	50	25	5	1,16
BM1266	1	6	70	25	5	2,04
BM1267	1	6	100	25	5	4,48
BM1268	1,2	6,5	50	25	5	1,16
BM1269	1,2	6,5	70	25	5	2,04
BM1270	1,2	8	50	25	5	1,54
BM1271	1,2	8	70	25	5	2,45

*Valor Unidade

FENDA TITÂNIO

PONTA DE 1/4" DE FENDA REVESTIDA A TITÂNIO



CÓDIGO	Ø mm	L mm	PCS	€*	
BM1290	0,5	3	25	10	1,79
BM1291	0,6	4	25	10	1,79
BM1292	0,6	4,5	25	10	1,79
BM1293	0,8	5,5	25	10	1,79
BM1294	1,2	6,5	25	10	1,79

*Valor Unidade

BITS

BITS
EMBOUTS

BITS PH COLOR

PONTA DE 1/4"

58/60 HRC 

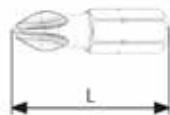

CÓDIGO		L mm	PCS	€*
BMC001	PH1	25	10	0,76
BMC002	PH2	25	10	0,76
BMC003	PH3	25	10	0,76

*Valor Unidade

BITS PH COLOR LONGO

PONTA DE 1/4" LONGA

58/60 HRC 

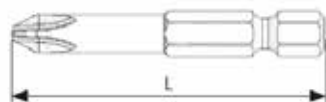

CÓDIGO		L mm	PCS	€*
BMC004	PH1	50	5	1,38
BMC005	PH2	50	5	1,38
BMC006	PH3	50	5	1,38

*Valor Unidade

BITS PZ COLOR

PONTA DE 1/4" PARA PARAFUSOS TORX - REVESTIDA A DIAMANTE

58/60 HRC 

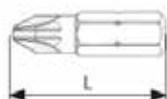

CÓDIGO		L mm	PCS	€*
BMC007	PZ1	25	10	0,76
BMC008	PZ2	25	10	0,76
BMC009	PZ3	25	10	0,76

*Valor Unidade

BITS

BITS
EMBOUTS

BITS PZ COLOR LONGO

PONTA DE 1/4" LONGA

58/60 HRC 

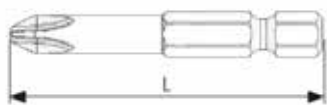

CÓDIGO		L mm	PCS	€*
BMC010	PZ1	50	5	1,38
BMC011	PZ2	50	5	1,38
BMC012	PZ3	50	5	1,38

*Valor Unidade

BITS TX COLOR

PONTA DE 1/4" PARA PARAFUSOS TORX

58/60 HRC 

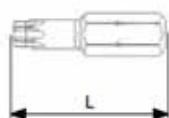

CÓDIGO		L mm	PCS	€*
BMC013	TX10	25	10	0,82
BMC014	TX15	25	10	0,82
BMC015	TX20	25	10	0,82
BMC016	TX25	25	10	0,82
BMC017	TX27	25	10	0,82
BMC018	TX30	25	10	0,82
BMC019	TX40	25	10	0,82

*Valor Unidade

BITS TX COLOR LONGO

PONTA DE 1/4" LONGA PARA PARAFUSOS TORX

58/60 HRC 



CÓDIGO		L mm	PCS	€*
BMC020	TX10	50	5	2,51
BMC021	TX15	50	5	2,51
BMC022	TX20	50	5	2,51
BMC023	TX25	50	5	2,51
BMC024	TX27	50	5	2,51
BMC025	TX30	50	5	2,51
BMC026	TX40	50	5	2,51

*Valor Unidade

BITS PLADUR

BITS
EMBOUTS

BITS PH MAG PLADUR COM RETENÇÃO MAGNÉTICA

PONTA DE 1/4"

58/60 HRC 



CÓDIGO		L mm	PCS	€*
BM0850	PH1	25	10	1,95
BM0851	PH2	25	10	1,95
BM0852	PH3	25	10	1,95

*Valor Unidade

BITS PH MAG PLADUR LONGO COM RETENÇÃO MAGNÉTICA

PONTA DE 1/4" LONGA

58/60 HRC 

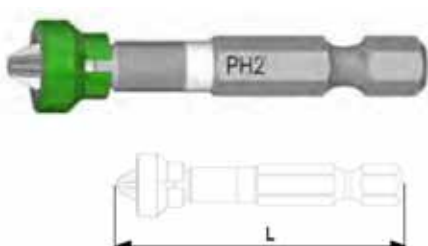

CÓDIGO		L mm	PCS	€*
BM0853	PH1	50	5	2,29
BM0854	PH2	50	5	2,29
BM0855	PH3	50	5	2,29

*Valor Unidade

BITS PZ MAG PLADUR COM RETENÇÃO MAGNÉTICA

PONTA DE 1/4" LONGA

58/60 HRC 



CÓDIGO		L mm	PCS	€*
BM0856	PZ1	25	10	1,89
BM0857	PZ2	25	10	1,89
BM0858	PZ3	25	10	1,89

*Valor Unidade

BITS PLADUR

BITS
EMBOUTS

BITS PZ MAG PLADUR LONGO COM RETENÇÃO MAGNÉTICA

PONTA DE 1/4" LONGA



CÓDIGO		L mm	PCS	€*
BM0859	PZ1	50	5	1,99
BM0860	PZ2	50	5	1,99
BM0861	PZ3	50	5	1,99

*Valor Unidade

BITS TX MAG PLADUR COM RETENÇÃO MAGNÉTICA

PONTA DE 1/4" LONGA



CÓDIGO		L mm	PCS	€*
BM0862	TX10	25	10	1,97
BM0863	TX15	25	10	1,97
BM0864	TX20	25	10	1,97
BM0865	TX25	25	10	1,97
BM0866	TX27	25	10	1,97
BM0867	TX30	25	10	1,97
BM0868	TX40	25	10	1,97

*Valor Unidade

BITS TX MAG PLADUR LONGO COM RETENÇÃO MAGNÉTICA

PONTA DE 1/4" LONGA



CÓDIGO		L mm	PCS	€*
BM0869	TX10	50	5	2,39
BM0870	TX15	50	5	2,39
BM0871	TX20	50	5	2,39
BM0872	TX25	50	5	2,39
BM0873	TX27	50	5	2,39
BM0874	TX30	50	5	2,39
BM0875	TX40	50	5	2,39

*Valor Unidade

ADAPTADORES DE BITS

BITS ADAPTERS
ADAPTATEURS

Adaptador Quick Lock

ADAPTADOR MAGNÉTICO DE 1/4" COM SISTEMA DE BLOQUEIO



CÓDIGO	Ø mm	L mm	PCS	€*
BM2000	14	60	5	8,03
BM2001	14	75	5	10,13
BM2002	14	100	5	20,79
BM2003	14	120	5	20,97
BM2004	14	150	5	22,02
BM2005	14	200	5	23,06
BM2006	14	250	5	24,39

*Valor Unidade

Adaptador Magnético Standard (sem anel)

ADAPTADOR MAGNÉTICO DE 1/4" SEM ANEL



CÓDIGO	Ø mm	L mm	PCS	€*
BM2020	10	50	5	3,92
BM2021	10	60	5	3,99
BM2022	10	75	5	4,79
BM2023	10	100	5	8,32
BM2024	10	120	5	11,26
BM2025	10	150	5	11,74
BM2026	10	200	5	13,21
BM2027	10	250	5	21,53

*Valor Unidade

Adaptador Magnético Standard (com anel)

ADAPTADOR MAGNÉTICO DE 1/4" COM ANEL



CÓDIGO	Ø mm	L mm	PCS	€*
BM2040	10	50	5	4,89
BM2041	10	60	5	5,07
BM2042	10	75	5	5,67
BM2043	10	100	5	8,56
BM2044	9,8	120	5	11,74
BM2045	10	150	5	12,34
BM2046	9,8	200	5	13,70
BM2047	11	250	5	22,02
BM2048	11	400	5	24,47

*Valor Unidade

Adaptador Magnético Industrial Reforçado

ADAPTADOR MAGNÉTICO COM ANEL CORPO REFORÇADO

























CÓDIGO	Ø mm	L mm	PCS	€*
BM2061	11	60	5	5,59
BM2062	11	75	5	5,80

*Valor Unidade

BITBOX



















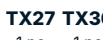



BITBOX
BITBOX



BITBOX 26			
Composição 26 PCS			
 PH1 1 pc	 PH2 2 pcs	 PH3 1 pc	 PZ1 1 pc
	 PZ2 2 pcs	 PZ3 1 pc	 3 1 pc
			 4 1 pc
			 5,5 1 pc
			 6,5 1 pc
 Adaptador 1/4 C a 1/4 C 1 pc	 TX10 1 pc	 TX15 1 pc	 TX20 1 pc
	 TX25 1 pc	 TX30 1 pc	 CH5 1 pc
			 CH6 1 pc
			 CH7 1 pc
			 CH8 1 pc
			 CH10 1 pc
			 CH13 1 pc
		 1x Chave	 1x Adaptador Magnético

CÓDIGO	€
BM0706	26,47

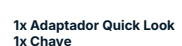

BITBOX 32			
Composição 32 PCS			
 HEX3 1 pc	 HEX4 1 pc	 HEX5 1 pc	 TX10 1 pc
			 TX15 1 pc
			 TX20 1 pc
 HEX6 1 pc	 TX25 1 pc	 TX27 1 pc	 TX30 1 pc
 3 1 pc	 4 1 pc	 PH1 1 pc	 PH2 1 pc
 5 1 pc	 6 1 pc	 PH3 1 pc	 PZ1 1 pc
		 PZ2 1 pc	 PZ3 1 pc
		 1x Adaptador Quick Look	 1x Chave
		 1x Mini Adaptador	

CÓDIGO	€
BM0701	21,84

MYBIT 7

MYBIT 7
MYBIT 7

MYBIT 7 - Fresado



CÓDIGO	€
BM0736*	9,70

Composição 7 PCS					
PH1	PH2	PZ1	PZ2	TX25	TX30
1 pc	1 pc	1 pc	1 pc	1 pc	1 pc



Características:

- Novo design.
- Esforço de torção distribuído ao longo do corpo do bit.
- Aplicações profissionais.
- Tinta resistente a óleo.

Composição 12 jogos

CÓDIGO	€
BM0741*	116,42



MYBIT 7 - Colour



CÓDIGO	€
BM0733*	10,73

Composição 7 PCS					
PH1	PH2	PZ1	PZ2	TX20	TX25
1 pc	1 pc	1 pc	1 pc	1 pc	1 pc



Características:

- Novo design.
- Esforço de torção distribuído ao longo do corpo do bit.
- Aplicações profissionais.
- Tinta resistente a óleo.

Composição 12 jogos

CÓDIGO	€
BM0742*	128,77



MYBIT 7 - Torção



CÓDIGO	€
BM0734*	10,92

Composição 7 PCS					
PH2	PH3	PZ2	PZ3	TX25	TX30
1 pc	1 pc	1 pc	1 pc	1 pc	1 pc



Características:

- Novo design.
- Esforço de torção distribuído ao longo do corpo do bit.
- Resistência do aço a impactos em materiais duros.
- Reduzido desgaste e aumento de vida útil.

Composição 12 jogos

CÓDIGO	€
BM0743*	131,04



*Até fim de existência







MYBIT 7

MYBIT 7
MYBIT 7

MYBIT 7 - Titânio



CÓDIGO	€
BM0735*	12,95

Composição 7 PCS					
					
PH1	PH2	PZ1	PZ2	TX15	TX20
1 pc	1 pc	1 pc	1 pc	1 pc	1 pc



Características:

- Revestimento de nitrato de titânio 2500HV de dureza.
- Resistente ao esforço fricção de materiais duros.
- Resistente ao desgaste e à oxidação.

Composição 12 jogos







CÓDIGO	€
BM0744*	155,36



MYBIT 7 - Impacto



CÓDIGO	€
BM0732*	20,90

Composição 7 PCS					
					
PH2	PH3	PZ2	PZ3	TX30	TX40
1 pc	1 pc	1 pc	1 pc	1 pc	1 pc



Características:

- Para utilização em máquinas de impulso.
- Alta resistência em altas velocidades.
- Suporta 300% mais esforço.
- Perfil reduzido de forma a resistir à torção e absorver deformações.

Composição 12 jogos

CÓDIGO	€
BM0745*	250,74



*Até fim de existência



JK LIMAS



2024

LIMAS COM CABO

FILES WITH HANDLES
LIMES AVEC CÂBLE



Limas de Mecânico Paralelas

CÓDIGO	Tipo	Corte	Medida		PCS	€
			Polegadas	mm		
JKL001	Bastardo		4	100	6	2,52
JKL002	Bastardo		6	150	6	2,99
JKL003	Bastardo		8	200	6	3,86
JKL004	Bastardo		10	250	6	5,27
JKL005	Bastardo		12	300	6	7,06
JKL006	Bastardo		14*	350	6	9,84
JKL007	Murço		4	100	6	2,82
JKL008	Murço		6	150	6	3,30
JKL009	Murço		8	200	6	4,46
JKL010	Murço		10	250	6	5,82
JKL011	Murço		12	300	6	7,79
JKL012	Murço		14*	350	6	10,87

*Medida 14 sem cabo incluído



Limas de Mecânico 1/2 Cana

CÓDIGO	Tipo	Corte	Medida		PCS	€
			Polegadas	mm		
JKL033	Bastardo		4	100	6	4,82
JKL034	Bastardo		6	150	6	4,89
JKL035	Bastardo		8	200	6	5,63
JKL036	Bastardo		10	250	6	7,85
JKL037	Bastardo		12	300	6	11,71
JKL038	Bastardo		14*	350	6	16,06
JKL039	Murço		4	100	6	5,14
JKL040	Murço		6	150	6	6,03
JKL041	Murço		8	200	6	8,18
JKL042	Murço		10	250	6	10,43
JKL043	Murço		12	300	6	13,16
JKL044	Murço		14*	350	6	19,37

*Medida 14 sem cabo incluído



Limas de Mecânico Quadradas

CÓDIGO	Tipo	Corte	Medida		PCS	€
			Polegadas	mm		
JKL048	Bastardo		4	100	6	3,15
JKL049	Bastardo		6	150	6	3,46
JKL050	Bastardo		8	200	6	3,60
JKL051	Bastardo		10	250	6	5,77
JKL052	Bastardo		12	300	6	9,63
JKL053	Murço			4	100	6
JKL054	Murço	6		150	6	3,69
JKL055	Murço	8		200	6	5,06
JKL056	Murço	10		250	6	6,34
JKL057	Murço	12		300	6	9,63



LIMAS COM CABO

FILES WITH HANDLES
LIMES AVEC CÂBLE



Limas de Mecânico Chatas

CÓDIGO	Tipo	Corte	Medida		PCS	€
			Polegadas	mm		
JKL018	Bastardo		4	100	6	2,52
JKL019	Bastardo		6	150	6	2,99
JKL020	Bastardo		8	200	6	3,86
JKL021	Bastardo		10	250	6	5,27
JKL022	Bastardo		12	300	6	7,06
JKL023	Bastardo		14*	350	6	9,84
JKL024	Murço		4	100	6	2,82
JKL025	Murço		6	150	6	3,30
JKL026	Murço		8	200	6	4,46
JKL027	Murço		10	250	6	5,82
JKL028	Murço		12	300	6	7,79
JKL029	Murço		14*	350	6	12,39

*Medida 14 sem cabo incluído



Limas de Mecânico Redondas

CÓDIGO	Tipo	Corte	Medida		PCS	€
			Polegadas	mm		
JKL061	Bastardo		4	100	6	2,65
JKL062	Bastardo		6	150	6	2,69
JKL063	Bastardo		8	200	6	3,60
JKL064	Bastardo		10	250	6	4,98
JKL065	Bastardo		12	300	6	7,06
JKL066	Bastardo		14*	350	6	11,48
JKL067	Murço		4	100	6	4,21
JKL068	Murço		6	150	6	4,25
JKL069	Murço		8	200	6	5,95
JKL070	Murço		10	250	6	6,54
JKL071	Murço		12	300	6	8,62
JKL072	Murço		14*	350	6	13,36

*Medida 14 sem cabo incluído



Limas de Mecânico Triangulares

CÓDIGO	Tipo	Corte	Medida		PCS	€
			Polegadas	mm		
JKL075	Bastardo		4	100	6	2,70
JKL076	Bastardo		6	150	6	3,32
JKL077	Bastardo		8	200	6	4,69
JKL078	Bastardo		10	250	6	6,77
JKL079	Bastardo		12	300	6	9,18
JKL080	Murço		4	100	6	3,09
JKL081	Murço		6	150	6	3,55
JKL082	Murço		8	200	6	5,01
JKL083	Murço		10	250	6	6,93
JKL084	Murço		12	300	6	11,17



LIMAS COM CABO

FILES WITH HANDLES

LIMES AVEC CÂBLE



Limas de Mecânico Tipo Faca

CÓDIGO	Tipo	Corte	Medida		PCS	€
			Polegadas	mm		
JKL114	Bastardo		4	100	6	5,55
JKL115	Bastardo		6	150	6	5,66
JKL116	Bastardo		8	200	6	7,40
JKL117	Bastardo		10	250	6	9,07
JKL118	Bastardo		12	300	6	10,63
JKL119	Murço		4	100	6	6,02
JKL120	Murço		6	150	6	6,10
JKL121	Murço		8	200	6	8,10
JKL122	Murço		10	250	6	10,10
JKL123	Murço		12	300	6	11,71



Limas de Mecânico Paralelas Finas (Folha de Oliveira)

CÓDIGO	Tipo	Corte	Medida		PCS	€
			Polegadas	mm		
JKL105	Murço		4	100	6	2,76
JKL106	1/2 Murço		4	110	6	2,65
JKL107	1/2 Murço		5	125	6	2,76
JKL108	1/2 Murço		6	150	6	2,91
JKL109	1/2 Murço		8	175	6	3,17



Limas para Serras Triangulares

CÓDIGO	Tipo	Corte	Medida		PCS	€
			Polegadas	mm		
JKL088	Regular		4	100	6	2,65
JKL089	Regular		4,5	110	6	2,87
JKL090	Regular		5	125	6	2,95
JKL091	Regular		6	150	6	3,11
JKL092	Regular		7	175	6	3,56
JKL093	Regular		8	200	6	4,62
JKL094	Regular		10	250	6	6,72
JKL095	Fina		4	100	6	2,65
JKL096	Fina		4,5	110	6	2,87
JKL097	Fina		5	125	6	2,95
JKL098	Fina		6	150	6	3,11
JKL099	Fina		7	175	6	3,56
JKL100	Fina		8	200	6	4,62
JKL101	Fina		10	250	6	6,55

LIMAS PARA MOTOSSERRAS, PARA CHAPEIRO E ARMAÇÃO

FILES

LIME POUR TRONÇONNEUSES, POUR CHAPELIER ET CADRES



Limas para Motosserras

CÓDIGO	Tipo	Corte	Medida		PCS	€
			Polegadas	mm		
JKL127	Redonda		1/8	3,2	12	1,34
JKL128	Redonda		9/64	3,5	12	1,34
JKL129	Redonda		5/32	4	12	1,34
JKL130	Redonda		11/64	4,5	12	1,34
JKL131	Redonda		3/16	4,8	12	1,34
JKL132	Redonda		13/64	5,16	12	1,34
JKL133	Redonda		7/32	5,5	12	1,34
JKL134	Redonda		15/64	6	12	1,34
JKL135	Redonda		1/4	6,3	12	1,34
JKL136	Redonda		5/16	8	12	1,34
JKL137	Redonda	3/8	9,6	12	1,34	



Limas com Dentes Fresados para Chapeiro

CÓDIGO	Tipo	Corte	Medida		PCS	€
			Polegadas	mm		
JKL140	Fresado		14	350	12	19,47



Armação para Limas com Dentes Fresados para Chapeiro

CÓDIGO	Tipo	Medida		PCS	€
		Polegadas	mm		
JKL141	Flexível	14	350	1	40,17

GROSAS E CABOS

FILES AND HANDLES
GAZON ET CÂBLE



Grosas 1/2 Cana

CÓDIGO	Tipo	Corte	Medida		PCS	€
			Polegadas	mm		
JKL144	Grosa		6	150	6	5,06
JKL145	Grosa		8	200	6	7,06
JKL146	Grosa		10	250	6	10,10
JKL147	Grosa		12	300	6	11,17
JKL148	Grosa		14*	350	6	12,00

*Medida 14 sem cabo incluído



Grosas Redondas

CÓDIGO	Tipo	Corte	Medida		PCS	€
			Polegadas	mm		
JKL150	Grosa		6	150	6	3,56
JKL151	Grosa		8	200	6	5,06
JKL152	Grosa		10	250	6	5,77
JKL153	Grosa		12	300	6	7,06



Cabos para Limas e Grosas

CÓDIGO	Medida	PCS	€
JKC03	Universal	1	2,81

Expositor de Limas

Composição 108 limas

UN	Tipo		
6	Paralelas Bastardo	6"	(150mm)
6	Paralelas Bastardo	8"	(200mm)
6	Paralelas Bastardo	10"	(250mm)
6	Redondas Bastardo	6"	(150mm)
6	Redondas Bastardo	8"	(200mm)
6	Redondas Bastardo	10"	(250mm)
6	Chatas Bastardo	6"	(150mm)
6	Chatas Bastardo	8"	(200mm)
6	Chatas Bastardo	10"	(250mm)
6	Triangulares Bastardo	6"	(150mm)
6	Triangulares Bastardo	8"	(200mm)
6	Triangulares Bastardo	10"	(250mm)
6	½ Cana Bastardo	6"	(150mm)
6	½ Cana Bastardo	8"	(200mm)
6	½ Cana Bastardo	10"	(250mm)
6	Quadradas Bastardo	6"	(150mm)
6	Quadradas Bastardo	8"	(200mm)
6	Quadradas Bastardo	10"	(250mm)



OFERTA DO EXPOSITOR

CÓDIGO	€
JKLB96	462,59



LIMAS DE CALADO

DRAFT FILES
LIMES



Limas de Calado Paralelas

CÓDIGO	Tipo	Medida	PCS	€
JKL160	Bastardo	160	12	3,28
JKL162	Murço	160	12	3,28



Limas de Calado Triangulares

CÓDIGO	Tipo	Medida	PCS	€
JKL168	Bastardo	160	12	3,28
JKL170	Murço	160	12	3,28



Limas de Calado 1/2 Cana

CÓDIGO	Tipo	Medida	PCS	€
JKL176	Bastardo	160	12	3,28
JKL178	Murço	160	12	3,28



Limas de Calado Redondas

CÓDIGO	Tipo	Medida	PCS	€
JKL180	Bastardo	160	12	3,28
JKL182	Murço	160	12	3,28



Limas de Calado Tipo Faca

CÓDIGO	Tipo	Medida	PCS	€
JKL184	Bastardo	160	12	3,28
JKL186	Murço	160	12	3,28



Limas de Calado Chatas

CÓDIGO	Tipo	Medida	PCS	€
JKL164	Bastardo	160	12	3,28
JKL166	Murço	160	12	3,28



Limas de Calado Quadradas

CÓDIGO	Tipo	Medida	PCS	€
JKL172	Bastardo	160	12	3,28
JKL174	Murço	160	12	3,28



Jogo de Limas de Calado

CÓDIGO	Tipo	Medida	PCS	€
JKL190	Bastardo (Paral., Chata, Triang., Quad., 1/2 Cana e Red.)	160	6	19,66
JKL191	Murço (Paral., Chata, Triang., Quad., 1/2 Cana e Red.)	160	6	19,66
JKL192	Bastardo* (Paral., Chata, Triang., Quad., 1/2 Cana e Red.)	160	6	39,31
JKL193	Murço* (Paral., Chata, Triang., Quad., 1/2 Cana e Red.)	160	6	39,31

* +6 limas de acabamento

LIMAS DIAMANTADAS GRÃO D-126

D-126 DIAMOND FILES



CÓDIGO	Tipo	Corte	PCS	€
JKLD01	Paralela	160	1	23,43
JKLD02	Chata	160	1	23,43
JKLD03	Triangular	160	1	23,43
JKLD04	Quadrada	160	1	23,43
JKLD05	1/2 Cana	160	1	23,43
JKLD06	Redonda	160	1	23,43
JKLD07	Tipo Faca	160	1	23,43



JOGO DE LIMAS

Composição 6 limas

Tipo D - 126
Medida 160

1	Paralela
1	Chata
1	Triangular
1	Quadrada
1	1/2 Cana
1	Redonda

CÓDIGO	€
JKLD20	140,54



Wi

Precision a

WIKUS[®]

Precision at the cutting point

WIKUS[®]

Precision at the cutting point

MA

WIKUS[®]

Precisão no ponto de corte

WIKUS



PRIMAR[®] M42



PROFLEX[®] M42



MARATHON[®] M42



2025

SERRAS PARA SERROTE MANUAL E MECÂNICO HSS E BIMETÁLICAS

HSS AND BIMETALLIC MANUAL AND MECHANICAL SAWS
SCIES HSS ET BI-MÉTAL POUR LE SCIAGE MANUEL ET MÉCANIQUE

HSS BIMETÁLICA

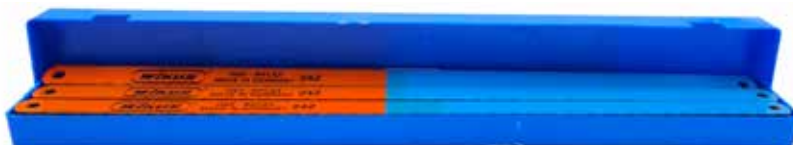

Folhas para Serrote Manual Bimetálica

CÓDIGO	Medida			PCS	€	
WFS02	300	x	12,5	24D	50	2,23

HSS BIMETÁLICA



Folha para Serrote Mecânico HSS - Bimetálica

CÓDIGO	Medida			Dentes	PCS	€	
WFM001	300	x	25	1,25	6	1	12,64
WFM002	300	x	25	1,25	10	1	12,64
WFM003	350	x	32	1,60	6	1	18,36
WFM004	350	x	32	1,60	10	1	18,36
WFM005	400	x	32	1,60	6	1	20,85
WFM006	400	x	32	1,60	10	1	20,85
WFM007	450	x	32	1,60	6	1	23,98
WFM008	450	x	32	1,60	10	1	23,98
WFM009	450	x	38	2,00	6	1	32,99
WFM010	450	x	38	2,00	10	1	32,99
WFM011	500	x	38	2,00	6	1	36,83
WFM012	500	x	38	2,00	10	1	36,83
WFM013	550	x	50	2,50	6	1	63,35
WFM014	550	x	50	2,50	10	1	63,35
WFM015	600	x	50	2,50	6	1	75,50
WFM016	600	x	50	2,50	10	1	75,50
WFM017	700	x	50	2,50	6	1	87,73
WFM018	700	x	50	2,50	10	1	87,73

HSS



Folha para Serrote Mecânico HSS

CÓDIGO	Medida			Dentes	PCS	€	
WFM200	300	x	25	1,25	6	1	16,20
WFM201	300	x	25	1,5	10	1	16,20
WFM202	350	x	32	2,00	6	1	18,05
WFM203	350	x	32	2,00	10	1	18,05
WFM204	400	x	32	1,60	6	1	22,87
WFM205	400	x	32	1,60	10	1	22,87
WFM206	450	x	32	1,60	6	1	26,40
WFM207	450	x	32	1,60	10	1	26,40
WFM208	450	x	38	2,00	6	1	32,82
WFM209	450	x	38	2,00	10	1	32,82
WFM210	500	x	10	2,00	6	1	41,13
WFM211	500	x	10	2,00	10	1	41,13
WFM212	550	x	50	2,50	6	1	69,77
WFM213	550	x	50	2,50	10	1	69,77
WFM214	600	x	50	2,50	6	1	81,42
WFM215	600	x	50	2,50	10	1	81,42

ROLOS DE FITA DE SERRA EM AÇO CARBONO E M42 (BIMETÁLICA)

SAW RIBBON ROLLERS IN CARBON STEEL AND M42 (BIMETALLIC)

ROULEAUX DE SCIE À RUBAN EN ACIER AU CARBONE ET M42 (BIMÉTALLIQUES)



Aço Carbono

Ref: 500 Wikus Extra (Rolos 30,5m)

CÓDIGO	Medida	€
WR00058	10 x 4	90,70
WR00024	10 x 6	90,70
WR00030	13 x 4	104,67
WR00055	16 x 4	133,26
WR00037	16 x 6	133,26
WR00042	20 x 6	163,85
WR00031	13 x 6	104,67

Aço Carbono

Ref: 510 Wikus Diamante (Rolos 30,5m)

CÓDIGO	Medida	€
WR20010	5 x 10	117,91
WR20011	6 x 6	117,91
WR20012	6 x 8	117,91
WR20013	6 x 10	117,91
WR20014	6 x 14	117,91
WR20015	6 x 18	117,91
WR20016	6 x 24	117,91
WR20017	8 x 6	117,91
WR20018	8 x 8	117,91
WR20019	8 x 10	117,91
WR20020	8 x 14	117,91
WR20021	8 x 18	117,91
WR20022	8 x 24	117,91
WR20023	10 x 6	117,91
WR20024	10 x 8	117,91
WR20025	10 x 10	117,91
WR20026	10 x 14	117,91
WR20027	10 x 18	117,91
WR20028	10 x 24	117,91
WR20029	13 x 4	134,83
WR20030	13 x 6	134,83
WR20031	13 x 8	134,83
WR20032	13 x 10	134,83
WR20033	13 x 14	134,83
WR20035	13 x 24	134,83
WR20036	16 x 6	179,78
WR20038	16 x 10	179,78
WR20039	16 x 14	179,78
WR20041	20 x 6	211,06
WR20042	20 x 8	211,06
WR20043	20 x 10	211,06
WR20046	25 x 4	259,44
WR20047	25 x 6	259,44
WR20049	25 x 10	259,44

Aço M42 (Bimetálica)

Dente Progressivo (Rolos 30,5m)

CÓDIGO	Largura	Dente	€ p/metro
WR10000	6	x 10/14	394,38
WR10001	10	x 10/14	394,38



Aço M42 (Bimetálica)

Dente Progressivo (Rolos entre 80 e 134m)

CÓDIGO	Largura	Dente	€ p/metro
WR10002	13	x 6 / 10	12,91
WR10003	13	x 8 / 12	12,91
WR10004	13	x 10 / 14	12,91
WR10005	20	x 4 / 6	14,44
WR10006	20	x 5 / 8	14,44
WR10007	20	x 6 / 10	14,44
WR10008	20	x 8 / 12	14,44
WR10009	20	x 10 / 14	14,44
WR10010	27	x 4 / 6	18,20
WR10011	27	x 5 / 8	18,20
WR10012	27	x 6 / 10	18,20
WR10013	27	x 8 / 12	18,20
WR10014	27	x 10 / 14	18,20
WR10015	34	x 4 / 6	18,45
WR10016	34	x 5 / 8	18,45
WR10017	34	x 6 / 10	18,45

Observação:

Para encontrar o preço de cada rolo, deve multiplicar o preço por metro pela medida do rolo.

SELEÇÃO DE FITA

SAW SELECTION
SÉLECTION DU RUBAN

DIVERSIDADE	BIMETAIS						METAIS DUROS					
	APLICAÇÃO											
		LEVEL 2	LEVEL 3	LEVEL 1	LEVEL 2	LEVEL 3	LEVEL 1	LEVEL 2	LEVEL 3	LEVEL 1	LEVEL 2	ESPECIAL
Ligas à base de níquel												
Aços duplex e aços resistentes ao calor												
Titânio, ligas à base de titânio												
Bronze de alumínio												
Aços temperados (mais de 1000 N/mm ²)												
Aços inoxidáveis e resistentes a ácidos (austeníticos)												
Aços inoxidáveis e resistentes a ácidos (ferríticos)												
Aços de nitração e aços rápidos												
Ferro fundido												
Aços para ferramentas												
Aços cementados, aços mola e aços para rolamentos de esferas												
Aços de carbono e aços temperados												
Aços para construção, aços de embutidura profunda e aços para automáticos												
Metais não ferrosos												
Alumínio / ligas à base de alumínio												

Lâminas de Serras de Fita de Aço Alto-Carbono



- Adequado para operações de oficina até à maquinabilidade de materiais compostos.
- Pontas dos dentes endurecidos e um corpo especialmente flexível garantem uma alta confiabilidade.

Modo de Distribuição:	- Em rolos de comprimentos fixos e fabricação até 120m, dependendo das larguras - Serras de fita soldadas
Larguras da Fita:	- 5 até 25 mm
Tipo de Dentes:	- L, S, K
Passos:	- 3 até 24 dentes por polegada (dpp)
Travas:	- SD, WS, GS

SERRAS DE FITA DE AÇO ALTO-CARBONO

HIGH CARBON STEEL SAW STRIP

SCIES À RUBAN EN ACIER À HAUTE TENEUR EN CARBONE

EXTRA

- Para operações simples nas oficinas.
- Para aços de liga de baixa resistência.



Dimensões				Passo de dpp			€ p/metro
Largura	x	Espessura	6	SD			
mm		Polegada		4	3		
8	x	0,65	5/16 x 0,025	L		8,01	
10	x	0,65	3/8 x 0,025	S	S, L	L	8,01
13	x	0,65	1/2 x 0,025	S	S, L	L	8,43
16	x	0,80	5/8 x 0,032	S	S	L	10,70
20	x	0,80	3/4 x 0,032	S	S, L	L	13,02

Obs: para achar o preço da fita multiplicar o preço por metro X o comprimento da fita

L=Dente skip S=Dente padrão



SERRAS DE FITA DE AÇO ALTO-CARBONO

HIGH CARBON STEEL SAW STRIP

SCIES À RUBAN EN ACIER À HAUTE TENEUR EN CARBONE

DIAMANT

- Para operações simples nas oficinas.
- Para aços de liga de baixa resistência.



Dimensões				Passo de dpp										€ p/metro		
Largura mm	x	Espessura Polegada		SD					WS			GS				
				18	14	10	8	6	4	3	24	14	4			
5	x	0,40	3/16 x 0,016		S								S			8,66
5	x	0,65	3/16 x 0,025	S	S	S							S			8,66
6	x	0,40	1/4 x 0,016						K							8,66
6	x	0,65	1/4 x 0,025	S	S	S	S	S,K	K				S		K	8,66
8	x	0,65	5/16 x 0,025	S	S	S	S	S,K	K				S		K	8,66
10	x	0,65	3/8 x 0,025	S	S	S	S	S,K	K	K			S			8,66
13	x	0,65	1/2 x 0,025		S	S	S	S,K	S,K	K			S			9,21
16	x	0,50	5/8 x 0,020		S		S									11,49
16	x	0,65	5/8 x 0,025			S	S	S,K	S,K	K			S			11,49
16	x	0,80	5/8 x 0,032			S		K	K	K			S			11,49
20	x	0,80	3/4 x 0,032			S	S	K	K	K			S			13,44
25	x	0,90	1 x 0,035			S		S	S,K	S,K						13,44

Obs: para achar o preço da fita multiplicar o preço por metro X o comprimento da fita

S=Dente padrão K=Dente hook



Lâminas de Serras de Fita Bimetálicas Material de Corte M42

- Portfólio de produtos ótimo para aplicações padrão e especiais.
- Corpo da fita em liga de aço temperado com propriedades ideais de funcionamento contínuo.
- Material de corte M42 comprovado com uma excelente resistência ao desgaste em aplicações convencionais.
- Versões revestidas para os máximos desempenhos de corte e maiores vidas úteis.

Modo de Distribuição:	- Em rolos de comprimentos fixos e fabricação até 120m, dependendo das larguras - Serras de fita soldadas
Larguras da Fita:	- 6 até 80 mm
Tipo de Dentes:	- S, P, K, HV, VA
Passos:	- 0,7 - 1,0 até 12 - 16 dentes por polegada
Travas:	- SD
Qualidades:	- M42: 68 - 69 HRC, aprox. 980 HV
Projetos Especiais:	- PW: disponível em grupos de produtos: SKALAR M42, SKALAR PREMIUM M42, SELEKTA GS M42 - PE: Disponível em grupos de produtos: VARIO M42, MARATHON M42

SERRAS DE FITA BIMETÁLICA

BIMETAL SAW BLADES

SCIES À RUBAN BIMÉTALLIQUES

VARIO M42

- Para aplicação universal em cortes individuais e em série.
- Para perfis e material maciço.
- Para corte coletivo ou em camadas.



Dimensões				Passo de dpp					€ p/metro	
Largura mm	x	Espessura Polegada		10-14	8-12	6-10	5-8	4-6		3-4
6	x	0,65	14 x 0,025	S						19,66
6	x	0,90	1/4 x 0,035	S						19,66
10	x	0,90	3/8 x 0,035	S						19,66
13	x	0,65	1/2 x 0,025	S	S	S				19,66
13	x	0,90	1/2 x 0,035	S	S	S				19,66
20	x	0,90	3/4 x 0,035	S	S	S	S	S		19,66
27	x	0,90	1-1/16 x 0,035	S	S	S	S	S	S	21,20
34	x	1,10	1-3/8 x 0,042		S	S	S	S	S	24,16
41	x	1,30	1-5/8 x 0,050			S	S	S	S	31,89
54	x	1,30	2-1/8 x 0,050			S				47,01
Diâmetro do material				<20mm	10-30mm	20-50mm	30-60mm	50-90mm	90-150mm	

Obs: para achar o preço da fita multiplicar o preço por metro X o comprimento da fita

*Venda até ao fim de existência

S=Dente padrão



SERRAS DE FITA BIMETÁLICA

BIMETAL SAW BLADES

SCIÉS À RUBAN BIMÉTALLIQUES

PRIMAR M42

- Peças de trabalho de pequena e média dimensão.
- Material maciço e perfis.
- Aplicação industrial e em oficinas.
- Todos os metais até 1000 N/mm² de resistência à tração.

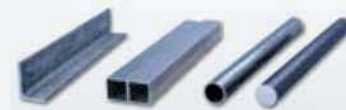

Dimensões				Passo de dpp								€ p/metro	
Largura	x	Espessura		10-14	8-12	6-10	5-8	4-6	3-4	2-3	1:4-2		1-1.4
mm		Polegada											
6	x	0,65	1/4 x 0,025	S									16,80
6	x	0,90	1/4 x 0,035	S									16,80
10	x	0,90	3/8 x 0,035	S									16,80
13	x	0,6,5	1/2 x 0,025	S	S	S							16,80
20	x	0,90	3/4 x 0,035	S	S	S	S	K					19,65
27	x	0,90	1-1/16 x 0,035	S	S	S	S	K	K	K			19,65
34	x	1,10	1-3/8 x 0,042		S	S	S	K	K	K			23,45
41	x	1,30	1-5/8 x 0,050					K	K	K	K		29,80
54	x	1,60	2-1/8 x 0,063							K	K	K	50,65
Diâmetro do material						10-30mm	20-50mm	30-60mm	50-90mm	80-150mm	150-250mm		

Obs: para achar o preço da fita multiplicar o preço por metro X o comprimento da fita

S=Dente padrão K=Dente hook



SERRAS DE FITA BIMETÁLICA

BIMETAL SAW BLADES

SCIES À RUBAN BIMÉTALLIQUES

MARATHON M42

- Para aplicação universal em cortes individuais e em série.
- Para perfis e material maciço.
- Para corte coletivo ou em camadas.



Dimensões				Passo de dpp						€ p/metro	
Largura	x	Espessura		5-8	4-6	3-4	2-3	1,4-2	1,0-1,4		0,75-1,25
mm		Polegada									
27	x	0,90	1-1/16	x	0,035	K	K	K	K		21,21
34	x	1,10	1-3/8	x	0,042	K	K	K	K		24,15
38	x	1,30	1-1/2	x	0,050			K	K		s/consulta
41	x	1,30	1-5/8	x	0,050	K	K	K	K		31,89
54	x	1,30	2-1/8	x	0,050		K	K	K		s/consulta
54	x	1,60	2-1/8	x	0,063		K	K	K	K	49,64
67	x	1,60	2-5/8	x	0,063		K	K	K	K	74,82
80	x	1,60	3-1/8	x	0,063			K	K	K	187,46
Diâmetro do material				30-60mm	50-90mm	90-150mm	150-290mm	290-550mm	540-1020mm	570-1180mm	

Obs: para achar o preço da fita multiplicar o preço por metro X o comprimento da fita

MARATHON X3000 - M51

- Para aplicação universal.
- Para perfis e material maciço.
- Para corte coletivo ou em camadas.



Dimensões				Passo de dpp					€ p/metro	
Largura	x	Espessura		5-8	4-6	3-4	2-3	1,4-2		
mm		Polegada								
27	x	0,90	1-1/16	x	0,035	K	K	K		25,88
34	x	1,10	1-3/8	x	0,042		K	K		31,27
41	x	1,30	1-5/8	x	0,050		K	K		44,60
54	x	1,60	2-1/8	x	0,063		K	K	K	60,49
67	x	1,60	2-5/8	x	0,063			K	K	91,00
Diâmetro do material				30-60mm	50-90mm	90-150mm	150-290mm	290-550mm		

Obs: para achar o preço da fita multiplicar o preço por metro X o comprimento da fita

K=Dente hook



Figura abaixo: MARATHON M42



SERRAS DE FITA BIMETÁLICA

BIMETAL SAW BLADES

SCIES À RUBAN BIMÉTALLIQUES

MARATHON M42 DENTE FIXO

- Para aplicação universal em cortes individuais e em série.
- Para perfis e material maciço.
- Para corte coletivo ou em camadas.



Dimensões				Passo de dpp				€ p/metro		
Largura mm	x	Espessura Polegada		6	4	3	1,25			
13	x	0,65	1/2 x 0,025	K	K			19,65		
13	x	0,90	1/2 x 0,035	K	K	K		s/consulta		
20	x	0,90	3/4 x 0,035	K	K	K		19,65		
20	x	1,10	3/4 x 0,042			K		s/consulta		
34	x	1,10	1-3/8 x 0,042				K	23,45		
Diâmetro do material				30-60mm	50-90mm	90-150mm	150-290mm	290-550mm	540-1020mm	570-1180mm

Obs: para achar o preço da fita multiplicar o preço por metro X o comprimento da fita

K=Dente hook



Figura abaixo: MARATHON M42



SERRAS DE FITA BIMETÁLICA

BIMETAL SAW BLADES

SCIES À RUBAN BIMÉTALLIQUES

PROFLEX M42

- Geometria de dentes extra estável contra a quebra de dentes.
- Para utilização em oficina.
- Para perfis e vigas.



Dimensões				Passo de dpp							€ p/metro		
Largura	x	Espessura		14-18	12-16	10-14	8-11	7-9	5-7	4-6		3-4	2-3
mm		Polegada											
13	x	0,65	1/2 x 0,025	P		P	P	P					19,65
13	x	0,90	1/2 x 0x035			P	P	P					s/consulta
20	x	0,90	3/4 x 0,035		P	P	P	P	P	P			19,66
27	x	0,90	1-1/16 x 0,035		P	P	P	P	P	P	P		21,21
34	x	1,10	1-3/8 x 0,042				P	P	P	P	P	P	24,15
41	x	1,30	1-5/8 x 0,050				P	P	P	P	P	P	32,20
54	x	1,30	2-1/8 x 0,050					P		P	P	P	s/consulta
54	x	1,60	2-1/8 x 0,063							P	P	P	49,67
67	x	1,60	2-5/8 x 0,063								P	P	74,08
Diâmetro do material				< 5mm	< 10mm	< 15mm	15-30mm	20-50mm	40-70mm	50-90mm	90-160mm	160-310mm	

Obs: para achar o preço da fita multiplicar o preço por metro X o comprimento da fita

PROFLEX PREMIUM M42 (Revestida)

- Versão revestida.
- Para um maior desempenho de corte e aumento da vida útil.
- Para uma reduzida poluição sonora.



Dimensões				Passo de dpp				€ p/metro		
Largura	x	Espessura		12-16	8-11	5-7	4-6		3-4	2-3
mm		Polegada								
34	x	1,10	1-3/8 x 0,042				P	P		50,25
41	x	1,30	1-5/8 x 0,050			P		P	P	70,96
54	x	1,30	2-1/8 x 0,050					P		82,21
54	x	1,60	2-1/8 x 0,063					P	P	92,69
67	x	1,60	2-5/8 x 0,063					P	P	128,34
Diâmetro do material				30-60mm	10-40mm	40-70mm	50-90mm	90-160mm	160-310mm	

Obs: para achar o preço da fita multiplicar o preço por metro X o comprimento da fita

P=Dente perfilado



Figura abaixo: PROFLEX M42



SERRAS DE FITA BIMETÁLICA

BIMETAL SAW BLADES

SCIES À RUBAN BIMÉTALLIQUES

SKALAR M42

- Geometria de dentes retificada.
- Para uso eficaz no desempenho.
- Para aplicação universal.



Dimensões				Passo de dpp						€ p/metro
Largura mm	x	Espessura Polegada		2,5-3,4	1,8-2,5	1,4-1,8	1,2-1,6	1,0-1,4	0,7-1,0	
27	x	0,90	1-1/16 x 0,035	K						31,45
34	x	1,10	1-3/8 x 0,042	K	K					36,06
41	x	1,30	1-5/8 x 0,050	K	K	K				51,27
54	x	1,30	2-1/8 x 0,050	K	K	K				61,52
54	x	1,60	2-1/8 x 0,063	K	K	K	K	K		68,50
67	x	1,60	2-5/8 x 0,063			K	K	K	K	102,27
80	x	1,60	3-1/8 x 0,063				K	K	K	146,12
Diâmetro do material				120-200mm	200-340mm	300-550mm	400-700mm	500-1000mm	950-3000mm	

Obs: para achar o preço da fita multiplicar o preço por metro X o comprimento da fita

SKALAR PREMIUM M42 (Revestida)

- Versão revestida.
- Para um maior desempenho de corte.
- Para aumento da vida útil.



Dimensões				Passo de dpp						€ p/metro
Largura mm	x	Espessura Polegada		2,5-3,4	1,8-2,5	1,4-1,8	1,2-1,6	1,0-1,4	0,7-1,0	
27	x	0,90	1-1/16 x 0,035	K						49,90
34	x	1,10	1-3/8 x 0,042	K	K					55,91
41	x	1,30	1-5/8 x 0,050	K	K					77,35
54	x	1,60	2-1/8 x 0,063	K	K	K	K			103,33
67	x	1,60	2-5/8 x 0,063			K	K	K		143,59
Diâmetro do material				120-200mm	200-340mm	300-550mm	400-700mm	500-1000mm	950-3000mm	

Obs: para achar o preço da fita multiplicar o preço por metro X o comprimento da fita

SKALAR X3000 - M51

- Para aplicação universal em materiais de difícil maquinabilidade.
- Geometria de dentes retificada.
- Para uso eficaz no desempenho.



Dimensões				Passo de dpp						€ p/metro
Largura mm	x	Espessura Polegada		2,5-3,4	1,8-2,5	1,4-1,8	1,2-1,6	1,0-1,4	0,7-1,0	
27	x	0,90	1-1/16 x 0,035	K						35,75
34	x	1,10	1-3/8 x 0,042	K	K					41,67
41	x	1,30	1-5/8 x 0,050	K	K	K				59,05
54	x	1,30	2-1/8 x 0,050		K	K				61,73
54	x	1,60	2-1/8 x 0,063	K	K	K	K	K		78,75
67	x	1,60	2-5/8 x 0,063		K	K	K	K	K	118,10
80	x	1,60	3-1/8 x 0,063			K	K	K	K	161,02
100	x	1,60	4 x 0,063						K	329,33
Diâmetro do material				120-200mm	200-340mm	300-550mm	400-700mm	500-1000mm	950-3000mm	

Obs: para achar o preço da fita multiplicar o preço por metro X o comprimento da fita

K=Dente hook

Figura abaixo: SKALAR PREMIUM M42 (Revestida)



SERRAS DE FITA BIMETÁLICA

BIMETAL SAW BLADES

SCIÉS À RUBAN BIMÉTALLIQUES

SELEKTA GS M42

- Para uso eficaz no desempenho.
- Para uma qualidade da superfície ótima.
- Para um comportamento de corte perfeito.



Dimensões				Passo de dpp					€ p/metro	
Largura	x	Espessura		4-6	3-4	2-3	1,4-2	1,0-1,4		0,7-1,0
mm		Polegada								
27	x	0,90	1-1/16 x 0,035	K	K	K				31,33
34	x	1,10	1-3/8 x 0,042	K	K	K				36,56
41	x	0,90	1-5/8 x 0,035		K	K				s/consulta
41	x	1,30	1-5/8 x 0,050	K	K	K	K			51,23
54	x	1,30	2-1/8 x 0,050		K	K	K			64,46
54	x	1,60	2-1/8 x 0,063		K	K	K	K		73,76
67	x	1,60	2-5/8 x 0,063				K	K	K	108,49
80	x	1,60	3-1/8 x 0,063			K	K	K	K	156,40
Diâmetro do material				50-90mm	90-150mm	150-290mm	290-550mm	500-1000mm	950-3000mm	

Obs: para achar o preço da fita multiplicar o preço por metro X o comprimento da fita

SELEKTA GS X3000 - M51

- Para uso eficaz no desempenho.
- Para uma qualidade de superfície ótima.
- Para um comportamento de corte perfeito.



Dimensões				Passo de dpp					€ p/metro	
Largura	x	Espessura		4-6	3-4	2-3	1,4-2	1,0-1,4		0,7-1,0
mm		Polegada								
27	x	0,90	1-1/16 x 0,035	K	K	K				41,30
34	x	1,10	1-3/8 x 0,042	K	K	K				45,54
41	x	0,90	1-5/8 x 0,050	K	K	K	K			61,99
54	x	1,30	2-1/8 x 0,050			K	K			79,46
54	x	1,30	2-1/8 x 0,063		K	K	K	K		87,48
67	x	1,60	2-5/8 x 0,063			K	K	K	K	129,77
80	x	1,60	3-1/8 x 0,063			K		K	K	180,76
Diâmetro do material				50-90mm	90-150mm	150-290mm	290-550mm	500-1000mm	950-3000mm	

Obs: para achar o preço da fita multiplicar o preço por metro X o comprimento da fita

K=Dente hook



Figura abaixo: SELEKTA GS M42

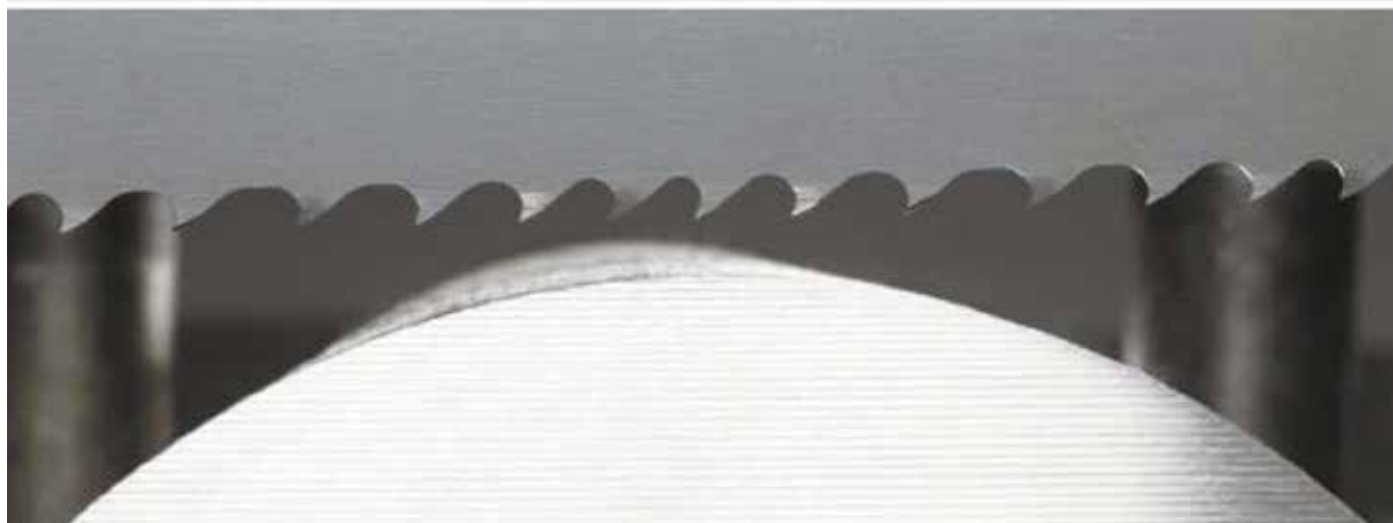

Lâminas de Serras de Fita com Dentes de Metal Duro



- Disponível em geometrias de dentes e ou trava especial.
- Resultados em todas as aplicações graças a dureza e composições diferentes dos metais duros utilizados.
- Elevadíssimo desempenho de corte para um aumento da produtividade da máquina.
- Fitas com revestimentos premium para os máximos desempenhos de corte.
- Longos períodos de funcionamento e desempenhos extremamente elevados dos nossos produtos high tech, graças ao material ideal do corpo.

Modo de Distribuição:	- Rolos com um máximo de 50m - Fitas de serra soldadas
Larguras da Fita:	- 13 até 100 mm
Tipo de Dentes:	- S, K, T, TSN
Passos:	- Constantes: 1,25 até 4 dentes por polegada (dpp) - Variados: 0,7-1,0 até 3-4 dpp
Travas:	- SD
Projetos Especiais:	- PW: Disponível em grupos de produtos: DUROSET, FUTURA, FUTURA PREMIUM, FUTURA VS, FUTURA PREMIUM VA

SERRAS DE FITA COM DENTES EM METAL DURO

CARBIDE SAW BLADES

SCIES À RUBAN AVEC DENTS EN MÉTAL DUR

DUROSET

- Versão com trava.
- Adequado para máquinas de serra de fita sem pacote de metal duro.
- Para uso universal em aços.



Dimensões				Passo de dpp					€ p/metro	
Largura	x	Espessura		2,5-3,4	1,8-2,5	1,4-2	1,0-1,4	0,7-1,0		
mm		Polegada								
27	x	0,90	1-1/16	x	0,035	K				s/consulta
34	x	1,10	1-3/8	x	0,042	K				s/consulta
41	x	1,30	1-5/8	x	0,050	K				s/consulta
54	x	1,30	2-1/8	x	0,050	K				s/consulta
54	x	1,60	2-1/8	x	0,063		K			s/consulta
67	x	1,60	2-5/8	x	0,063			K		s/consulta
80	x	1,60	3-1/8	x	0,063				K	s/consulta
Diâmetro do material				120-200mm	200-340mm	300-550mm	500-1000mm	950-3000mm		

Obs: para achar o preço da fita multiplicar o preço por metro X o comprimento da fita

DUROSET PREMIUM (Revestida)

- Versão revestida.
- Para aumento da vida útil.



Dimensões				Passo de dpp					€ p/metro	
Largura	x	Espessura		2,5-3,4	1,8-2,5	1,4-2	1,0-1,4	0,7-1,0		
mm		Polegada								
34	x	1,10	1-3/8	x	0,042					s/consulta
41	x	1,30	1-5/8	x	0,050		K			s/consulta
54	x	1,60	2-1/8	x	0,063		K			s/consulta
67	x	1,60	2-5/8	x	0,063			K		s/consulta
80	x	1,60	3-1/8	x	0,063				K	s/consulta
Diâmetro do material				120-200mm	200-340mm	300-550mm	500-1000mm	950-3000mm		

Obs: para achar o preço da fita multiplicar o preço por metro X o comprimento da fita

K=Dente hook



Figura abaixo: DUROSET PREMIUM

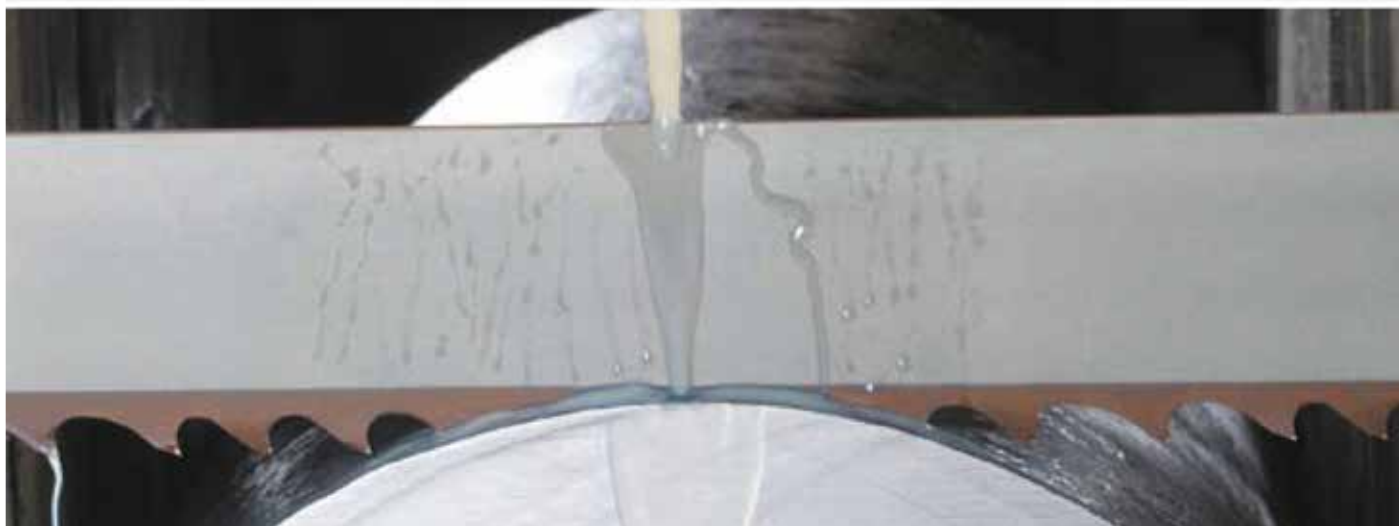

SERRAS DE FITA BIMETÁLICAS PARA MADEIRA

PRECISION BIMETAL BAND SAW BLADE FOR EFFICIENT WOOD CUTTING

LAME DE SCIE À RUBAN BIMÉTAL DE PRÉCISION POUR UNE DÉCOUPE EFFICACE DU BOIS

GENERO

- Pode ser reafiada várias vezes
- Passo dos dentes constante
- Base dos dentes arredondada, proporcionando elevada durabilidade, menor aderência de resinas e boa evacuação das aparas



Dimensões				Passo de dpp		€ p/metro	
Largura x Espessura				2	1,15		
mm		Polegada					
27	x	0,90	1-1/16	x	0,035	K	21,21
34	x	0,90	1-3/8	x	0,035	K	24,15
34	x	1,10	1-3/8	x	0,042	K*	24,15
41	x	1,10	1-5/8	x	0,042	K	31,89

*Ângulo de incidência opcional: 10° universal ou 7° especial.

Obs: para achar o preço da fita multiplicar o preço por metro X o comprimento da fita

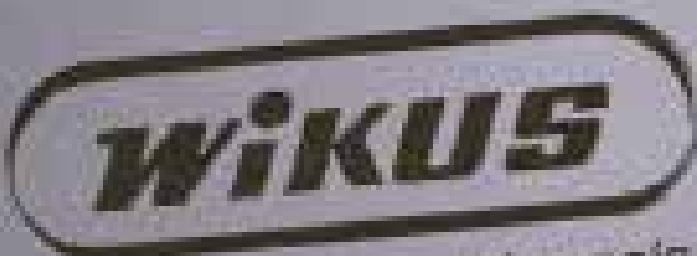

Precision at the cutting point

GEN

SERRAS DE FITA BIMETALICAS PARA MADEIRA

PRECISION BIMETAL BAND SAW BLADE FOR EFFICIENT WOOD CUTTING

LAME DE SCIE À RUBAN BIMÉTAL DE PRÉCISION POUR UNE DÉCOUPE EFFICACE DU BOIS

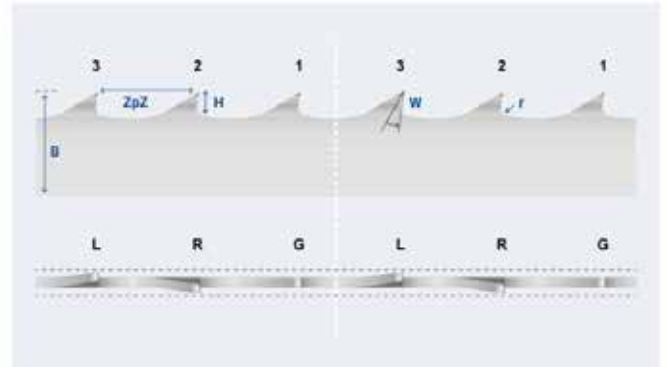

SERRAS DE FITA COM DENTES EM METAL DURO

CARBIDE SAW BLADES

SCIES À RUBAN AVEC DENTS EN MÉTAL DUR

FUTURA

- Dentes trapezoidais retificados.
- Para uso eficaz no desempenho.
- Para uso universal em aços.



Dimensões				Passo de dpp					€ p/metro
Largura	x	Espessura		3,4	2-3	1,4-2	1,0-1,4	0,85-1,15	
mm		Polegada							
27	x	0,90	1-1/16 x 0,035	T					s/consulta
34	x	1,10	1-3/8 x 0,042	T	T				s/consulta
41	x	1,30	1-5/8 x 0,050	T	T	T			s/consulta
54	x	1,30	2-1/8 x 0,050		T	T			s/consulta
54	x	1,60	2-1/8 x 0,063		T	T	T	T	s/consulta
67	x	1,60	2-5/8 x 0,063		T	T	T	T	s/consulta
80	x	1,60	3-1/8 x 0,063			T	T	T	s/consulta
Diâmetro do material				90-150mm	150-270mm	270-550mm	500-1000mm	700-1500mm	

Obs: para achar o preço da fita multiplicar o preço por metro X o comprimento da fita

FUTURA PREMIUM (Revestida)

- Versão revestida.
- Para o máximo desempenho na durabilidade.
- Para aumento da vida útil.



Dimensões				Passo de dpp					€ p/metro
Largura	x	Espessura		3,4	2-3	1,4-2	1,0-1,4	0,85-1,15	
mm		Polegada							
34	x	0,90	1-1/16 x 0,035	T	T				s/consulta
41	x	1,10	1-3/8 x 0,042	T	T	T			s/consulta
54	x	1,30	1-5/8 x 0,050		T	T			s/consulta
54	x	1,30	2-1/8 x 0,050		T	T	T		s/consulta
67	x	1,60	2-1/8 x 0,063		T	T	T	T	s/consulta
80	x	1,60	2-5/8 x 0,063			T	T	T	s/consulta
Diâmetro do material				90-150mm	150-270mm	270-550mm	500-1000mm	700-1500mm	

Obs: para achar o preço da fita multiplicar o preço por metro X o comprimento da fita

T=Dente trapezoidal



Figura abaixo: FUTURA PREMIUM



SERRAS DE FITA COM DENTES EM METAL DURO

CARBIDE SAW BLADES

SCIES À RUBAN AVEC DENTS EN MÉTAL DUR

TAURUS

- Para aplicação universal.



Dimensões				Passo de dpp					€ p/metro
Largura	x	Espessura		3,4	2-3	1,4-2	1,0-1,4	0,7-1,0	
mm		Polegada							
27	x	0,90	1-1/16	x	0,035	T			s/consulta
34	x	1,10	1-3/8	x	0,042	T	T		s/consulta
41	x	1,30	1-5/8	x	0,050	T	T	T	s/consulta
54	x	1,60	2-1/8	x	0,063	T	T	T	s/consulta
67	x	1,60	2-5/8	x	0,063	T	T	T	s/consulta
80	x	1,60	3-1/8	x	0,063		T	T	s/consulta
Diâmetro do material				90-150mm	150-270mm	270-550mm	500-1000mm	950-3000mm	

Obs: para achar o preço da fita multiplicar o preço por metro X o comprimento da fita

TAURUS PREMIUM (Revestida)

- Versão revestida.

- Para aumento da vida útil.



Dimensões				Passo de dpp					€ p/metro
Largura	x	Espessura		3,4	2-3	1,4-2	1,0-1,4	0,7-1,0	
mm		Polegada							
34	x	1,10	1-3/8	x	0,042	T	T		s/consulta
41	x	1,30	1-5/8	x	0,050	T	T	T	s/consulta
54	x	1,60	2-1/8	x	0,063		T	T	s/consulta
67	x	1,60	2-5/8	x	0,063		T	T	s/consulta
Diâmetro do material				90-150mm	150-270mm	270-550mm	500-1000mm	950-3000mm	

Obs: para achar o preço da fita multiplicar o preço por metro X o comprimento da fita

K=Dente trapezoidal



Figura abaixo: TAURUS



SERRAS DE FITA COM DENTES EM METAL DURO

CARBIDE SAW BLADES

SCIES À RUBAN AVEC DENTS EN MÉTAL DUR

ECODUR

- Uso universal em metais não ferrosos.



Dimensões				Passo de dpp				€ p/metro
Largura	x	Espessura						
mm		Polegada		3,4	2-3	1,4-2	0,85-1,15	
13	x	0,80	1/2 x 0,032	T				s/consulta
20	x	0,80	3/4 x 0,032	T				s/consulta
27	x	0,90	1-1/16 x 0,035	T	T			s/consulta
34	x	1,10	1-3/8 x 0,042	T	T	T		s/consulta
41	x	1,30	1-5/8 x 0,050	T	T	T		s/consulta
54	x	1,30	2-1/8 x 0,050		T	T		s/consulta
54	x	1,60	2-1/8 x 0,063	T	T	T	T	s/consulta
67	x	1,60	2-5/8 x 0,063			T		s/consulta
Diâmetro do material				90-150mm	150-270mm	270-550mm	550-1600mm	

Obs: para achar o preço da fita multiplicar o preço por metro X o comprimento da fita

DUROSET NE

- Trava extra longa.
- Para metais não ferrosos.
- Para operação manual.



Dimensões				Passo de dpp		€ p/metro
Largura	x	Espessura				
mm		Polegada		3	2	
20	x	0,90	3/4 x 0,035	K		s/consulta
27	x	0,90	1-1/16 x 0,035	K		s/consulta
34	x	1,10	1-3/8 x 0,042	K	K	s/consulta
Diâmetro do material				120-200mm	200-400mm	

Obs: para achar o preço da fita multiplicar o preço por metro X o comprimento da fita

K=Dente trapezoidal K=Dente hook



Figura abaixo: Ecodur

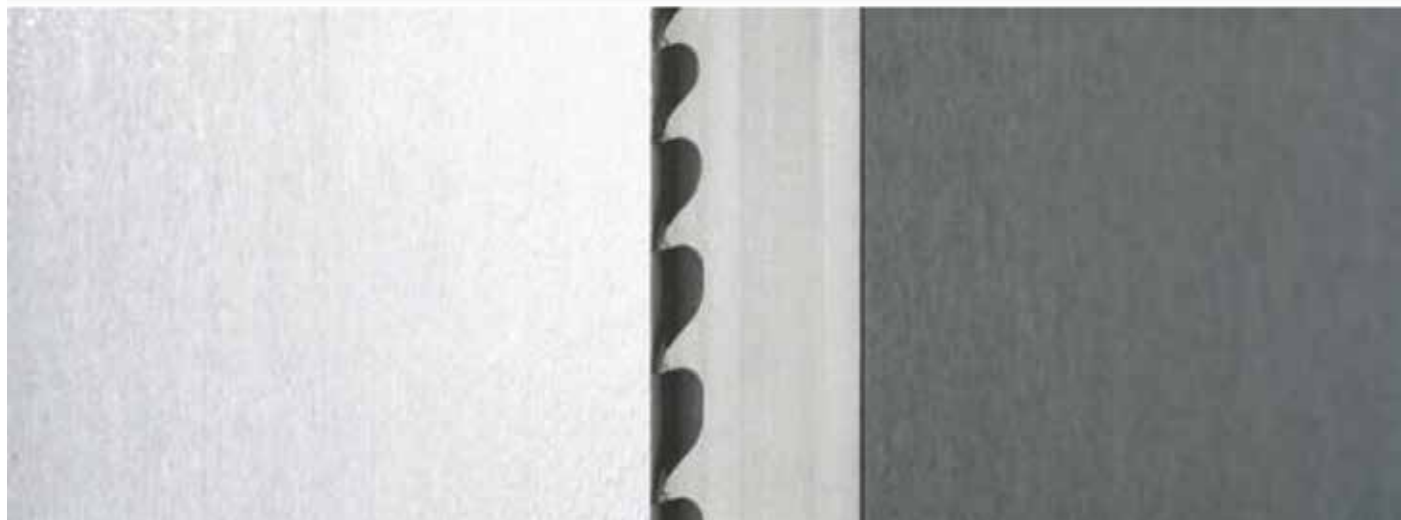

SERRAS DE FITA COM DENTES EM METAL DURO

CARBIDE SAW BLADES

SCIES À RUBAN AVEC DENTS EN MÉTAL DUR

PROFIDUR

- Para o corte potente de vigas e perfis.
- Para cortes com poucas rebarbas.
- Para excelentes qualidades de superfície.



Dimensões				Passo de dpp		€
Largura	x	Espessura		3-4	2-3	p/metro
mm		Polegada				
54	x	1,30	2-1/8 x 0,050		T	s/consulta
54	x	1,60	2-1/8 x 0,063	T	T	s/consulta
67	x	1,60	2-5/8 x 0,063		T	s/consulta
Diâmetro do material				90-150mm	150-270mm	

Obs: para achar o preço da fita multiplicar o preço por metro X o comprimento da fita

T=Dente trapezoidal

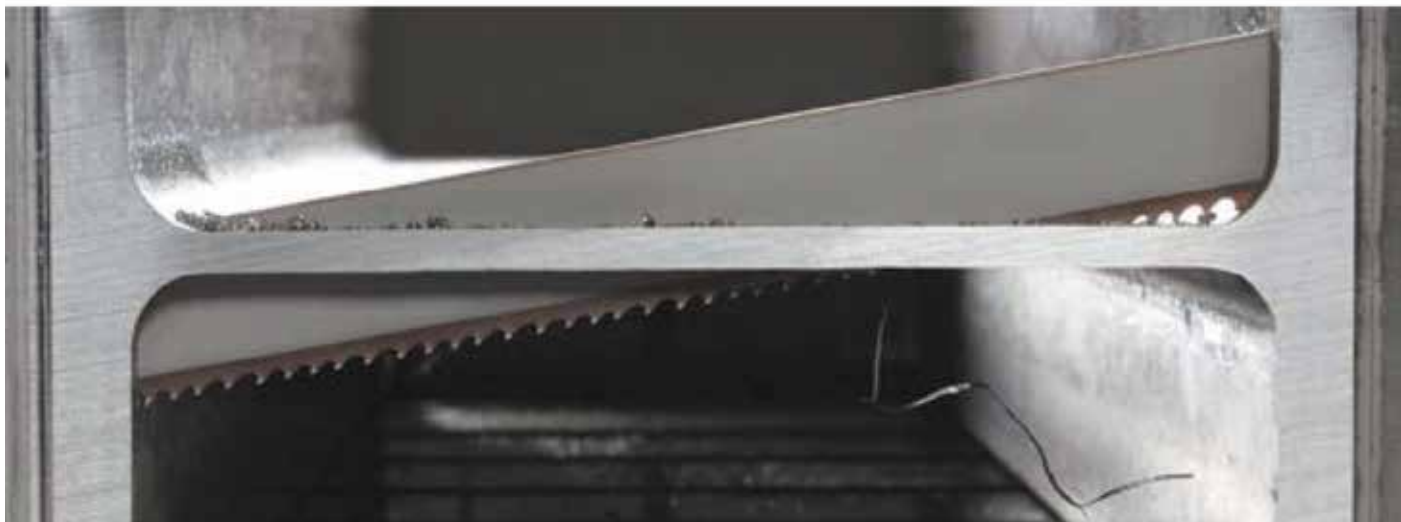

SERRAS DE FITA COM DENTES EM METAL DURO

CARBIDE SAW BLADES

SCIES À RUBAN AVEC DENTS EN MÉTAL DUR

FUTURA NE

- Desempenho de corte alto em metais não ferrosos.
- Para melhor acabamento superficial.
- Para aplicações em fundições e blocos de alumínio.



Dimensões				Passo de dpp					€ p/metro
Largura	x	Espessura		3,4	2-3	1,4-2	0,85-1,15	0,7-1,0	
mm		Polegada							
27	x	0,90	1-1/16	x	0,035	T			s/consulta
34	x	1,10	1-3/8	x	0,042	T	T		s/consulta
41	x	1,30	1-5/8	x	0,050	T	T		s/consulta
54	x	1,60	2-1/8	x	0,063		T	T	s/consulta
67	x	1,60	2-5/8	x	0,063		T		s/consulta
80	x	1,60	3-1/8	x	0,063			T	s/consulta
Diâmetro do material				90-150mm	150-270mm	270-550mm	550-1600mm	950-3000mm	

Obs: para achar o preço da fita multiplicar o preço por metro X o comprimento da fita

FUTURA NE RS

- Largura de canal de corte reduzida.
- Para blocos de alumínio.



Dimensões				Passo de dpp					€ p/metro
Largura	x	Espessura		3,4	2-3	1,4-2	0,85-1,15	0,7-1,0	
mm		Polegada							
41	x	1,30	1-5/8	x	0,050	T			s/consulta
54	x	1,30	2-1/8	x	0,050	T			s/consulta
54	x	1,60	2-1/8	x	0,063		T	T	s/consulta
80	x	1,10	3-1/8	x	0,042	T		T	s/consulta
Diâmetro do material				90-150mm	150-270mm	270-550mm	550-1600mm	950-3000mm	

Obs: para achar o preço da fita multiplicar o preço por metro X o comprimento da fita

T=Dente trapezoidal



Figura abaixo: FUTURA NE

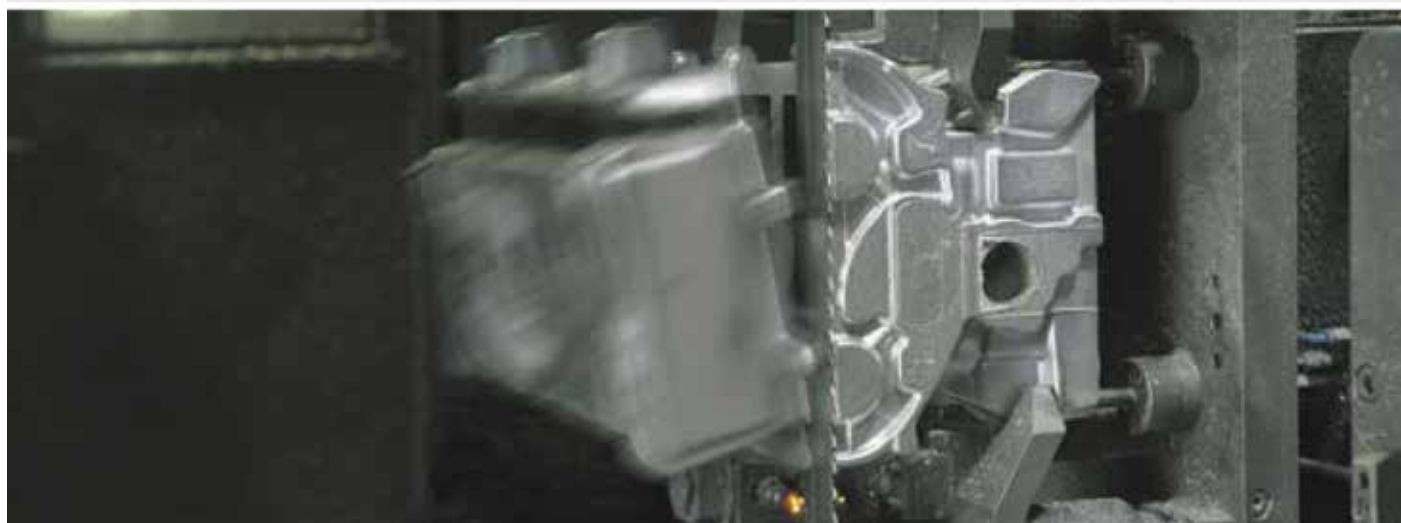

SERRAS DE FITA COM DENTES EM METAL DURO

CARBIDE SAW BLADES

SCIES À RUBAN AVEC DENTS EN MÉTAL DUR

TCT

- Serra de fita travada de metal duro.
- Para materiais abrasivos, minerais e grafite.
- Ferro fundido cinzento.



Dimensões				Passo de dpp				€ p/metro	
Largura mm	x	Espessura Polegada		4	3	2	1,25		
13	x	0,80	1/2	x	0,032	S			s/consulta
20	x	0,80	3/4	x	0,032	S	K		s/consulta
27	x	0,90	1-1/16	x	0,035	S,K	S, K	S,K	s/consulta
34	x	1,10	1-3/8	x	0,042		S, K	K	s/consulta
41	x	1,30	1-5/8	x	0,050		K	K	s/consulta
Diâmetro do material					80-120mm	120-200mm	200-400mm	300-800mm	

Obs: para achar o preço da fita multiplicar o preço por metro X o comprimento da fita

S=Dente padrão K=Dente hook

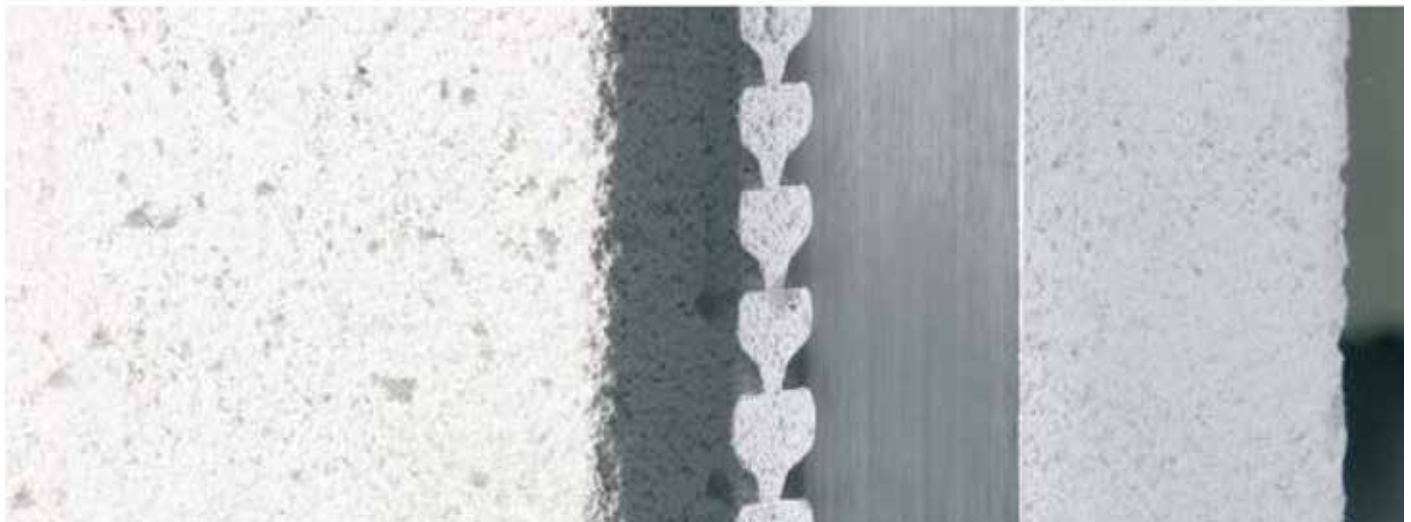

SERRAS DE FITA COM DENTES EM METAL DURO

CARBIDE SAW BLADES

SCIES À RUBAN AVEC DENTS EN MÉTAL DUR

TCTYRE

- Serra de fita especialmente desenvolvida para o corte de pneus.



Dimensões				Passo de dpp		€ p/metro
Largura mm	x	Espessura Polegada		3-4	3-2	
27	x	0,90	1-1/16 x 0,035	T	T	s/consulta
34	x	1,10	1-3/8 x 0,042	T	T	s/consulta
41	x	1,30	1-5/8 x 0,050	T	T	s/consulta
54	x	1,60	2-1/8 x 0,063		T	s/consulta
Diâmetro do material				90-150mm	150-270mm	

Obs: para achar o preço da fita multiplicar o preço por metro X o comprimento da fita

T=Dente trapezoidal

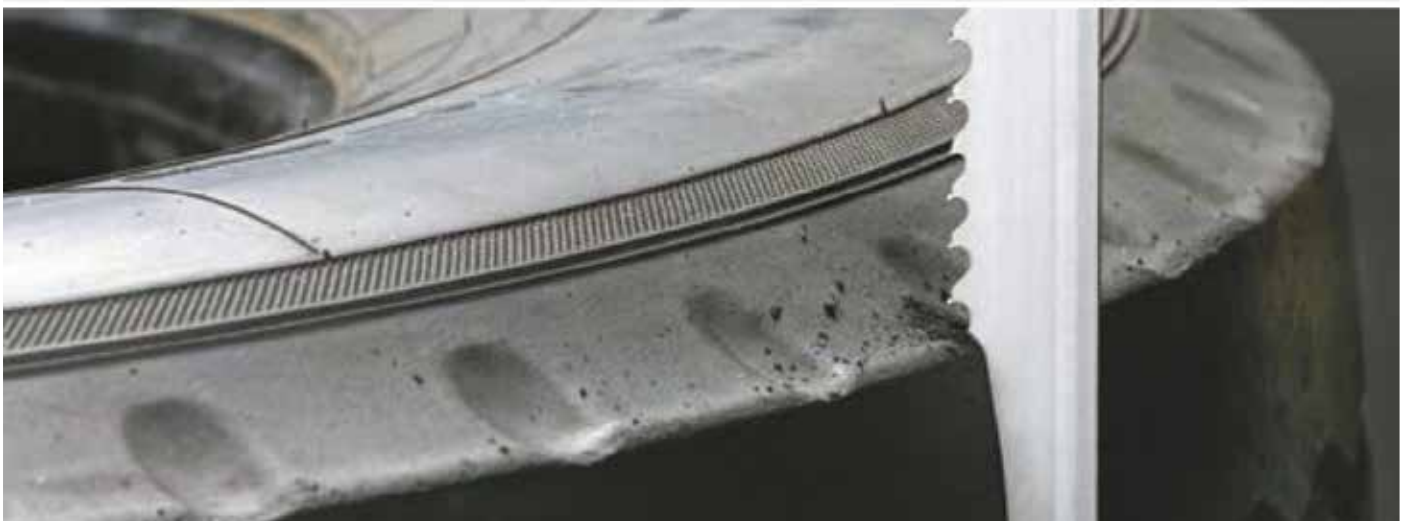

Lâminas de Serras de Fita com Revestimento de Diamante

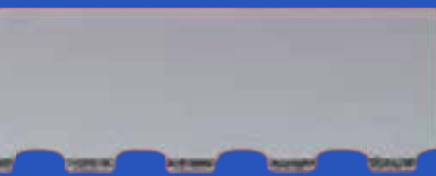

- Sendo conhecido como o material mais duro, o diamante é capaz de cortar qualquer material assim como ligas.

- As propriedades únicas da matéria prima desenvolvida para a WIKUS são perfeitamente capazes de resistir à dificuldade causada por cortes de alta velocidade.

- Devido às raras aplicações da DIAGRIT, recomendamos que nos contacte para melhor orientação.

Modo de Distribuição:	- Fitas de serra soldadas
Larguras da Fita:	- 10 até 100 mm
Revestimento Diamante:	- Contínua (K), Segmentada (S), com Garganta (U) com passo de 6 até 30 mm
Granulometrias:	- D64, D91, D126, D151, 181, D252, D301, D356, D426, D501, D601
Área de Aplicação:	- Silício, vidro, fibra de vidro, pedra natural
Opcional:	- Dimensões diferenciadas sob encomenda

SERRAS DE FITA COM REVESTIMENTO DE DIAMANTE

DIAMOND COATED SAW BLADE

SCIÉS À RUBAN REVÊTUES DE DIAMANT

DIAGRIT K

- Revestimento contínuo.
- Para uso eficaz no desempenho.
- Para peças de pequenas dimensões.



Dimensões				€ p/metro
Largura mm	x	Espessura Polegada		
10	x	0,50	3/8 x 0,020	s/consulta
13	x	0,50	1/2 x 0,020	s/consulta
13	x	0,65	1/2 x 0,025	s/consulta
16	x	0,50	5/8 x 0,020	s/consulta
20	x	0,50	3/4 x 0,020	s/consulta
20	x	0,80	3/4 x 0,032	s/consulta
27	x	0,50	1-1/16 x 0,020	s/consulta
27	x	0,70	1-1/16 x 0,028	s/consulta

Dimensões				€ p/metro
Largura mm	x	Espessura Polegada		
27	x	0,90	1-1/16 x 0,035	s/consulta
34	x	1,10	1-3/8 x 0,042	s/consulta
41	x	0,50	1-5/8 x 0,020	s/consulta
41	x	0,80	1-5/8 x 0,032	s/consulta
41	x	1,30	1-5/8 x 0,050	s/consulta
50	x	0,90	2 x 0,035	s/consulta
54	x	1,10	2-1/8 x 0,042	s/consulta

Obs: para achar o preço da fita multiplicar o preço por metro X o comprimento da fita

DIAGRIT K VA

- Corpo da fita de aço inoxidável.



Dimensões				€ p/metro
Largura mm	x	Espessura Polegada		
13	x	0,50	1/2 x 0,020	s/consulta
20	x	0,50	3/4 x 0,020	s/consulta
27	x	0,50	1-1/16 x 0,020	s/consulta

Dimensões				€ p/metro
Largura mm	x	Espessura Polegada		
41	x	0,50	1-5/8 x 0,020	s/consulta
54	x	1,10	2-1/8 x 0,042	s/consulta
60	x	0,50	2-1/3 x 0,020	s/consulta

Obs: para achar o preço da fita multiplicar o preço por metro X o comprimento da fita

Granulometrias: D64, D91, D126, D151, D181, D252, D301, D356, D426, D501, D601 (Dimensões diferenciadas sob encomenda)

Figura abaixo: DIAGRIT K

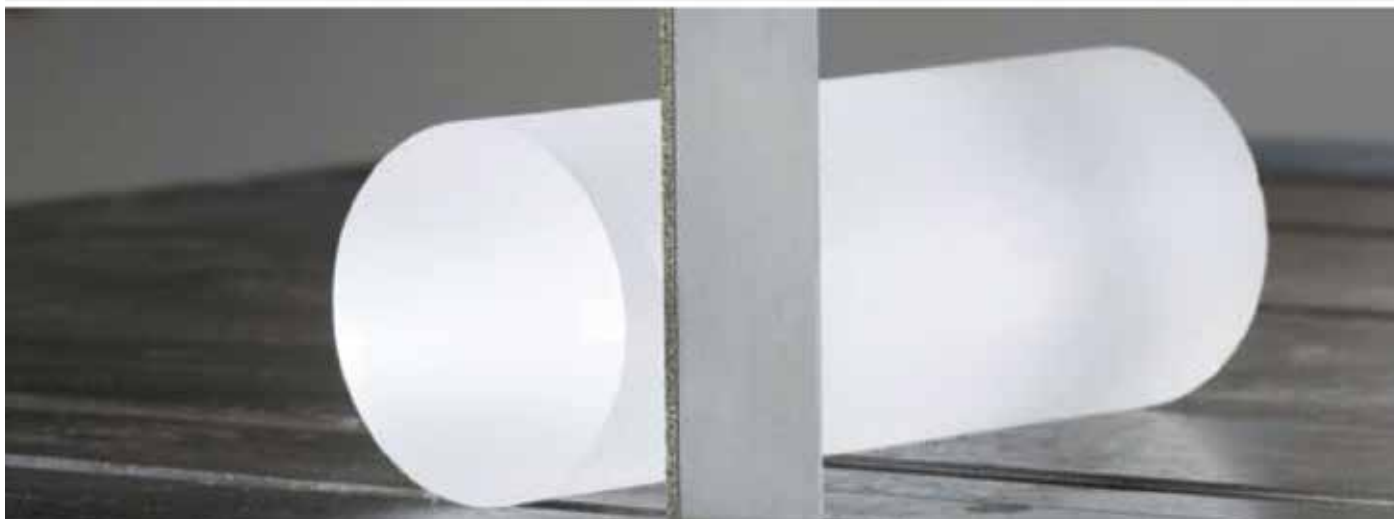

SERRAS DE FITA COM REVESTIMENTO DE DIAMANTE

DIAMOND COATED SAW BLADE
SCIES À RUBAN REVÊTUES DE DIAMANT

DIAGRIT S

- Disposição segmentada em forma retangular ou semi-circular.
- Para uso eficaz no desempenho.
- Para peças de pequenas dimensões.



Dimensões				€ p/metro
Largura mm	x	Espessura Polegada		
10	x	0,50	3/8 x 0,020	s/consulta
13	x	0,50	1/2 x 0,020	s/consulta
13	x	0,65	1/2 x 0,025	s/consulta
16	x	0,50	5/8 x 0,020	s/consulta
20	x	0,50	3/4 x 0,020	s/consulta
20	x	0,80	3/4 x 0,032	s/consulta
27	x	0,50	1-1/16 x 0,020	s/consulta
27	x	0,70	1-1/16 x 0,028	s/consulta

Dimensões				€ p/metro
Largura mm	x	Espessura Polegada		
27	x	0,90	1-1/16 x 0,035	s/consulta
34	x	1,10	1-3/8 x 0,042	s/consulta
41	x	0,50	1-5/8 x 0,020	s/consulta
41	x	0,80	1-5/8 x 0,032	s/consulta
41	x	1,30	1-5/8 x 0,050	s/consulta
50	x	0,90	2 x 0,035	s/consulta
54	x	1,10	2-1/8 x 0,042	s/consulta

Obs: para achar o preço da fita multiplicar o preço por metro X o comprimento da fita

DIAGRIT S VA

- Corpo da fita de aço inoxidável.



Dimensões				€ p/metro
Largura mm	x	Espessura Polegada		
13	x	0,50	1/2 x 0,020	s/consulta
20	x	0,50	3/4 x 0,020	s/consulta
27	x	0,50	1-1/16 x 0,020	s/consulta

Dimensões				€ p/metro
Largura mm	x	Espessura Polegada		
41	x	0,50	1-5/8 x 0,020	s/consulta
54	x	1,10	2-1/8 x 0,042	s/consulta
60	x	0,50	2-1/3 x 0,020	s/consulta

Obs: para achar o preço da fita multiplicar o preço por metro X o comprimento da fita

Granulometrias: D64, D91, D126, D151, D181, D252, D301, D356, D426, D501, D601 (Dimensões diferenciadas sob encomenda)



Figura abaixo: DIAGRIT S



SERRAS DE FITA COM REVESTIMENTO DE DIAMANTE

DIAMOND COATED SAW BLADE
SCIES À RUBAN REVÊTUES DE DIAMANT

DIAGRIT U

- Revestimento contínuo.
- Para uso eficaz no desempenho.
- Para peças de pequenas dimensões.



Dimensões				Passo T mm	€/p/metro
Largura mm	x	Espessura Polegada			
10	x	0,50	3/8 x 0,020	6	s/consulta
13	x	0,50	1/2 x 0,020	8	s/consulta
13	x	0,65	1/2 x 0,025	8	s/consulta
20	x	0,50	3/4 x 0,020	8	s/consulta
20	x	0,80	3/4 x 0,032	8	s/consulta
27	x	0,70	1-1/16 x 0,028	12	s/consulta
27	x	0,90	1-1/16 x 0,035	12	s/consulta
34	x	1,10	1-3/8 x 0,042	20	s/consulta

Dimensões				Passo T mm	€/p/metro
Largura mm	x	Espessura Polegada			
41	x	0,50	1-5/8 x 0,020	20	s/consulta
41	x	0,80	1-5/8 x 0,032	20	s/consulta
41	x	1,30	1-5/8 x 0,050	20	s/consulta
50	x	0,90	2 x 0,035	20	s/consulta
54	x	1,10	2-1/8 x 0,042	20	s/consulta
80	x	1,10	3-1/8 x 0,042	12	s/consulta
100	x	0,90	4 x 0,035	12	s/consulta
100	x	1,10	4 x 0,042	12	s/consulta

Obs: para achar o preço da fita multiplicar o preço por metro X o comprimento da fita

Granulometrias: D64, D91, D126, D151, D181, D252, D301, D356, D426, D501, D601 (Dimensões diferenciadas sob encomenda)



REFRATÓMETRO, TENSÍOMETRO E TABELA PARA SELEÇÃO DO DENTADO

REFRACTOMETER, TENSIO METER AND TOOTH PASS SELECTION TABLE
 RÉFRACTOMÈTRE, TENSIO MÈTRE ET TABLEAU DE SÉLECTION DES DENTS



Preço s/consulta

Refratômetro

Serve para medir a proporção de óleo e água a utilizar. A medida correta pode ser lida através de um visor em escala de 8% a 12%.



Preço s/consulta

Tensiómetro

Serve para medir a tensão da fita. É muito importante para o corte que a fita se encontre na sua tensão ideal, que será cerca de 300Nmm.

Tabela para Seleção do Dentado

Perfis, tubos e vigas

Até 1mm	12/16z 10/14z
1mm - 2,5mm	8/11z 8/12z
2,5mm - 5mm	5/7z 6/10z
5mm - 7mm	5/7z 5/8z
7mm - 10mm	3/4z 4/6z
10mm - 20mm	3/4z 3/4z
20mm - 45mm	2/3z 2/3z

Maciços

Até 10mm	10/14z
10mm - 20mm	8/12z
20mm - 40mm	6/10z
40mm - 50mm	5/8z
50mm - 90mm	4/6z
90mm - 120mm	3/4z
120mm - 150mm	2/3z

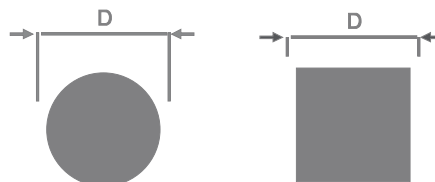
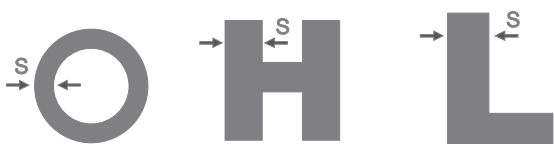

FORMAS DE DENTE, TIPO DE TRAVES, PASSO

TOOTH SHAPES, TYPE OF BRAKES, STEP

FORME DES DENTS, TYPE DE POUTRES, PENTE

FORMAS DE DENTE



Dente Skip (L)

Ângulo neutro de ataque, para:

- Materiais macios (alumínio e madeira), único na gama de aço ferramenta



Dente Hook (K)

Ângulo positivo de ataque, para:

- Uso universal
- Metais não ferrosos e aços
- Perfis e materiais sólidos



Dente Padrão (S)

Ângulo neutro de ataque, para:

- Materiais de cavaco curto
- Aços com alto teor de carbono
- Aço ferramenta e ferro fundido
- Peças com secções transversais pequenas
- Perfis de parede fina



Forma do Dente (HV)

Ângulo positivo e com diferença de dente definida, para:

- Alto desempenho de corte
- Material sólido
- Materiais de cavaco curto
- Aços temperados e revestidos

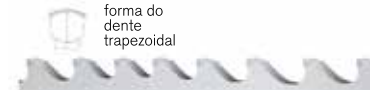

Dente Trapezooidal (T)

Ângulo positivo de ataque, para:

- Alto desempenho de corte
- Melhor acabamento superficial



Dente Perfilado (P)

Ângulo positivo de ataque, para:

- Perfis ocós e angulares
- Viga de aço
- Cortes de feixes e/ou camadas
- Operações sensíveis às vibrações



Forma do Dente (VA)

Ângulo extremo positivo e com diferença de dente definida, para:

- Alto desempenho de corte
- Material sólido
- Materiais de cavacos longos
- Aços inoxidáveis e resistentes ao ácido
- Superligas



Forma do Dente TSN (Dente Trapezooidal)

Ângulo negativo de ataque, para:

- Eixos com superfície endurecida
- Aços endurecidos até 62 HRC, aço manganês, peças chapeadas com cromo duro
- Diâmetro até 300 mm

TIPOS DE TRAVES

Possuindo dentes dispostos alternadamente para a esquerda e para a direita ao longo da lâmina, produzimos um corte livre.



Trave Regular (SD)

Aplicação universal para o corte de espessuras a partir de 5mm em aço, ferro fundido e metais não ferrosos duros. Passo de dente constante: sequência de trava esquerda / direita / reta. Passo de dente variável: pelo menos um dente reto por intervalo, o restante dos dentes no intervalo são alternadamente esquerda / direita ou travados em sequência inversa



Trave de Grupo (GS)

Para as serras de fita com um intervalo de passo de dente de 4 a 18 dpp, a trave de grupo permite obter um acabamento de superfície melhorado.



Trave Ondulada (SW)

Para os materiais até 5mm, como folhas, tubos de parede fina e perfis, recomendamos a trave ondulada

PASSO (Tz)

- Definimos como passo a quantidade de dentes em uma polegada (dpp). 1 polegada tem 25,4mm.
- Distingue-se entre o passo de dente constante, com uma distância uniforme entre os dentes, por ex. 2 dpp, e o passo de dente variável, com uma distância divergente entre os dentes.
- Passos variáveis, por ex. 2-3 dpp, são caracterizados por dois números de dimensões: 2 dpp é a distância máxima entre os dentes e a 3 dpp é a distância mínima entre os dentes no intervalo dos dentes.

Constante



Variável



INFORMAÇÃO TÉCNICA

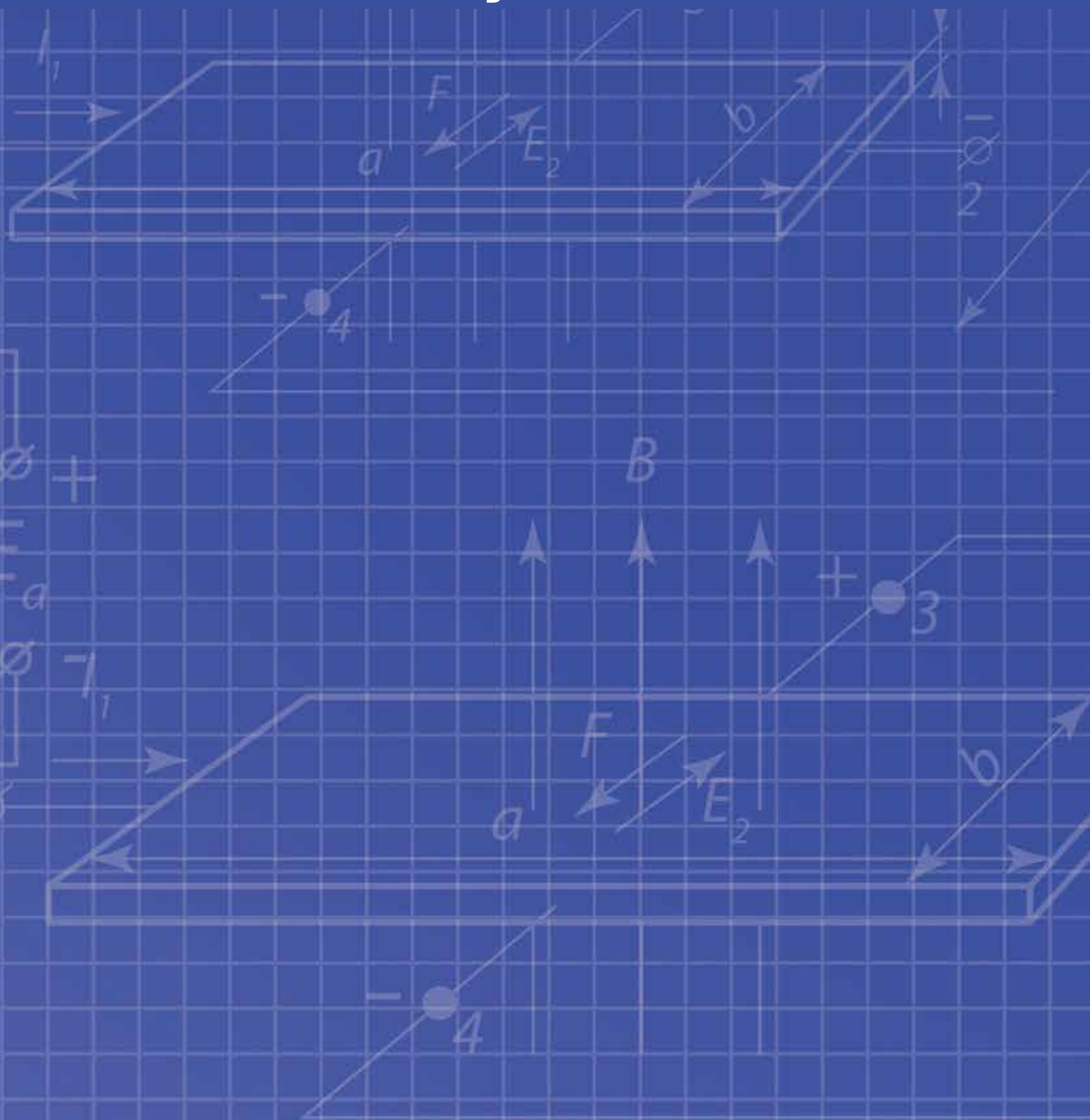

INFORMAÇÃO TÉCNICA

TECHNICAL SHEET
FICHE TECHNIQUE

Tabela de Seleção de Brocas em Função do Material a Trabalhar



Material a Trabalhar	Qualidade da Broca	Velocidade de Vorte mt / min	Broca diamante mm						Lubrificante	
			2	5	8	12	16	25		
Aço Comum	HSS	20 / 25								Óleo Corte Óleo Solúvel
	HSS-CO	25 / 30	0,05	0,12	0,20	0,25	0,30	0,40		
	M.D.	70 / 80								
Aço de Liga	HSS	10 / 12								Óleo Corte Óleo Solúvel
	HSS-CO	15 / 18	0,02	0,05	0,08	0,12	0,14	0,18		
	M.D.	30 / 50								
Aço de Liga AL, NI, CR	HSS	10 / 12								Óleo Corte Óleo Solúvel
	HSS-CO	15 / 18	0,05	0,14	0,18	0,22	0,25	0,40		
	M.D.	30 / 50								
Aço NI, CR, MO	HSS	8 / 10								Óleo Corte Óleo Solúvel
	HSS-CO	15 / 30	0,02	0,05	0,08	0,12	0,14	0,18		
	M.D.									
Aço Refratário (aço resistente à corrosão)	HSS-CO 8% ponta em M. D.	8 / 10 15 / 30	0,03	0,07	0,10	0,16	0,14	0,25		Óleo Corte Óleo Solúvel
Titânio	HSS-CO 8% ponta em M. D.	3 / 6 15 / 30	0,08	0,18	0,25	0,30	0,35	0,40		Óleo Corte
Fundição	HSS-CO 8% ponta em M. D.	20 / 35 25 / 30 40 / 60	0,03	0,07	0,10	0,16	0,20	0,25		Óleo Corte Seco
Bronze / Latão	HSS	20 / 35								Óleo Corte Óleo Solúvel
	HSS-CO	25 / 30	0,02	0,05	0,08	0,12	0,14	0,18		
	M.D.	40 / 100								
Alumínio	HSS	40 / 80	0,05	0,14	0,18	0,22	0,30	0,40		Óleo Corte Óleo Solúvel
	HSS-CO M.D.									
Liga de Alumínio	HSS	30 / 60	0,02	0,05	0,08	0,12	0,14	0,18		Óleo Corte Óleo Solúvel
Madeira	HSS	60 / 90	0,05	0,08	0,14	0,20	0,20	0,30		A seco
Borracha Dura	HSS	40 / 80	0,08	0,18	0,25	0,30	0,35	0,40		A seco

Tabela de Conversão da Velocidade de Corte em R. P. M. em Função do Diâmetro da Broca

Ø	Velocidade de Corte - mt / min													
	3	4	5	6	8	10	12	15	18	20	25	30	35	40
	R. P. M.													
2	478	637	796	955	1274	1592	1911	2388	2864	3185	3981	4777	5570	6369
3	318	425	531	637	849	1062	1274	1592	1909	2123	2654	3150	3713	4246
4	239	318	398	478	637	796	955	1194	1432	1592	1990	2389	2785	3185
5	191	255	318	382	510	637	764	955	1145	1274	1592	1911	2228	2548
6	159	212	265	318	425	531	637	796	954	1062	1327	1592	1856	2123
8	119	159	199	239	318	398	478	597	716	796	995	1194	1392	1592
10	96	127	159	191	255	318	382	478	572	637	796	955	1114	1274
12	80	106	133	159	212	265	318	398	477	531	663	796	928	1062
14	68	91	114	136	182	227	273	341	409	455	569	682	795	910
16	60	80	100	119	159	199	239	299	358	398	498	597	696	796
18	53	71	88	106	142	170	212	265	318	354	442	531	618	708
20	48	64	80	96	127	159	191	239	286	318	398	478	557	637
22	43	57	72	86	115	144	173	216	260	289	361	433	506	578
24	39	52	66	79	106	132	159	198	238	265	331	397	464	530
27	35	47	58	70	94	117	141	176	211	235	294	353	412	471
30	32	42	53	64	85	106	12	159	190	212	265	318	371	425

HSS - TIN + 20% com refrigeração

N. B. Os valores fornecidos nesta tabela são orientativos

HSS-CO TIALN + 50% a 80% a seco

INFORMAÇÃO TÉCNICA - TABELA DE VELOCIDADE DE CORTE EM R. P. M.

TECHNICAL SHEET - TABLE OF CUTTING SPEED IN RPM

FICHE TECHNIQUE - TABLEAU DES VITESSES DE COUPE EN R.P.M.

Brocas para Pedra com Pastilha



	Ø3	Ø4	Ø5	Ø6	Ø8	Ø10	Ø12	Ø14	Ø16
R. P. M.	2.300	2.300	2.000	1.600	1.400	1.300	1.000	800	600
N. B. : granito e pedra dura, reduzir a velocidade de 40% para 60%									

Brocas Universais "Fura Tudo"



Material a Trabalhar	Ø4	Ø6	Ø8	Ø10	Ø12	Ø14	Ø16
Pedra	2390	1590	1195	955	800	680	600
Plástico	4775	3185	2385	1910	1590	1365	1195
Aço XC (60-80Kg./mm)	1590	1060	800	640	530	455	400
Aço XC13 (90-110Kg./mm)	795	530	400	320	265	225	200
Vidro	400	285	220	170	140	125	110
Madeira Dura	1590	1060	800	640	530	455	400
Madeira Aglomerada	2385	1590	1195	955	795	680	595
N. B. : Trabalhar só em rotação, sem martelo							

Serras Craneanas



Material a Trabalhar	Ø Serra mm. R. P. M.															
	14 a 27	19 a 24	25 a 32	33 a 38	40 a 44	46 a 51	52 a 57	59 a 64	65 a 70	73 a 79	83 a 89	92 a 98	102 a 108	111 a 121	127 a 140	146 a 152
Ferro / Aço Mole	550	425	300	250	210	180	160	140	130	115	100	90	80	75	60	55
Aço trat. / Aço Inox	275	210	150	125	100	90	80	70	65	55	50	45	40	35	25	25
Cobre	365	280	200	165	135	120	105	95	85	75	65	60	55	50	40	35
Latão	730	560	400	330	270	240	210	190	170	150	130	120	110	100	85	75
Alumínio / Liga lig.	825	635	450	375	305	270	240	220	195	170	150	135	120	105	85	75
Madeira	900	670	510	390	320	280	250	230	200	180	160	140	130	120	100	95
Plástico	650	500	350	300	250	220	200	170	150	130	120	100	90	80	70	65
Gesso	900	670	510	390	320	250	230	200	180	160	140	130	120	100	95	80
HSS-CO + 20% com refrigeração																

Fresas para Martelo com Dentes em Metal Duro



Material a Trabalhar	R. P. M. 25 a 45	R. P. M. 45 a 65	R. P. M. 70 a 100	R. P. M. 110 a 130
Concreto / Parede	1.000	900	750	550
Cimento Armado	800	700	600	400

N. B. Os valores fornecidos nesta tabela são orientativos

INFORMAÇÃO TÉCNICA - TABELA DE VELOCIDADE DE CORTE EM R. P. M.

TECHNICAL SHEET - TABLE OF CUTTING SPEED IN RPM

FICHE TECHNIQUE - TABLEAU DES VITESSES DE COUPE EN R.P.M.



Fresas Escalonadas HSS

Material a Trabalhar		R. P. M.													
		1	2	3	4	5	6	7	8	9	10	21	22	23	24
Aço Inox	3 a 4 mm	600	600	400	400	280	280	200	160	220	160	340	280	220	220
Aço de Construção	3 a 4 mm	950	950	720	720	420	420	340	300	370	280	600	420	370	370
Aço de Liga	3 a 4 mm	1450	1450	1100	1100	630	630	500	470	550	440	900	630	550	550
Plástico	3 a 4 mm	900	900	700	700	400	400	320	300	350	270	550	400	350	350
HSS - TIN + 30% com refrigeração										HSS + TIALN + 50% a 80% a seco					



Fresas Perfuradoras HSS Retificadas

Material a Trabalhar	R. P. M.												
	12 a 17	18 a 24	25 a 32	33 a 38	39 a 44	46 a 51	52 a 57	58 a 64	65 a 70	71 a 80	81 a 90	91 a 100	
Aço Inox	400	350	280	230	200	180	150	120	100	80	70	60	
Aço de Construção	300	240	200	160	140	110	90	80	70	60	50	50	
Aço de Liga	360	270	230	180	170	150	120	90	80	70	60	50	
Plástico	1000	900	700	600	550	500	450	420	380	350	320	300	
HSS - TIN + 30% com refrigeração						HSS + TIALN + 50% a 80% a seco							



Fresas Perfuradoras TCT com Dentes em Metal Duro

Material a Trabalhar	R. P. M.							
	15 a 20	21 a 25	25 a 30	31 a 40	41 a 50	51 a 70	70 a 100	
Aço de Liga	800	600	500	450	380	280	100	
Aço Inox	520	400	330	280	250	180	150	
Cobre	1300	1100	950	700	550	380	280	

N. B. Os valores fornecidos nesta tabela são orientativos

INFORMAÇÃO TÉCNICA - TABELA DE VELOCIDADE DE CORTE EM R. P. M.

TECHNICAL SHEET - TABLE OF CUTTING SPEED IN RPM

FICHE TECHNIQUE - TABLEAU DES VITESSES DE COUPE EN R.P.M.



Fresas Rotativas em HSS

Ø mm	Velocidade de Corte mt. / min.							
	80	100	150	200	220	230	240	250
6	4250	5310	7960	10620	11680	12210	12740	13270
8	3180	3980	5970	7960	8760	9160	9550	9950
10	2550	3180	4780	6370	7010	7320	7640	7960
12	2120	2650	3980	5310	5840	6100	6370	6630
15	1700	2120	3180	4250	4670	4880	5100	5310



Fresas Rotativas em Metal Duro

Ø mm	Velocidade de Corte mt. / min.					
	300	320	340	360	380	400
6	15930	16980	18050	19100	20170	21230
8	11950	12740	13535	14330	15130	15920
10	9550	10190	10830	11465	12100	12740
12	7960	8490	9020	9560	10085	10620
16	5970	6370	6770	7160	7570	7960



Fresas para Máquinas com Base Eletromagnética em HSS

Ø mm	Aço 700 N/mm	Aço inox 1000 N/mm	Ferro Fundido	Alumínio
12 - 14	730	500	265	730
15 - 17	600	400	215	600
18 - 20	500	335	168	500
21 - 23	430	290	150	430
24 - 26	380	255	130	380
27 - 30	330	220	115	330
31 - 34	290	195	100	290
35 - 40	245	165	85	245
41 - 45	225	146	72	225
46 - 50	195	127	64	195
51 - 55	175	115		175
56 - 60	158	107		158
61 - 65	142	100		142
66 - 70	136	91		136
75 - 80	120	80		120
85 - 90	110	85		110
95 - 100	95	65		95

HSS-CO + 20% com refrigeração



Fresas para Máquinas com Base Eletromagnética em TCT

Ø mm	Aço 700 N/mm	Aço inox 1000 N/mm	Fundição
15 - 20	800	520	670
21 - 25	600	400	500
26 - 30	500	330	425
31 - 40	450	280	320
41 - 50	380	250	270
51 - 70	280	180	200
70 - 100	200	130	150
105 - 120	120	90	100

N. B. Os valores fornecidos nesta tabela são orientativos

INFORMAÇÃO TÉCNICA - TABELA DE VELOCIDADE DE CORTE EM R. P. M.

TECHNICAL SHEET - TABLE OF CUTTING SPEED IN RPM

FICHE TECHNIQUE - TABLEAU DES VITESSES DE COUPE EN R.P.M.



Serras Circulares HSS

Material a Trabalhar	R. P. M.								
	Ø 200	Ø 225	Ø 250	Ø 275	Ø 300	Ø 315	Ø 350	Ø 370	Ø 400
Aço de 50 Kg mm	64	56	50	46	42	40	36	34	32
Aço de 75 Kg mm	48	42	38	34	32	30	28	26	24
Aço de 100 Kg mm	32	28	25	23	21	20	18	17	16
Tubo Aço / Perfis	80	71	64	58	53	51	45	43	40
Fundição	64	56	50	46	42	40	36	34	32
Aço Inoxidável	24	21	19	17	16	15	14	13	12
Cobre / Bronze	318	283	255	231	12	202	182	172	159
Latão	637	566	509	463	424	404	364	344	318
Perfis e Aliações Lig.	2069	1839	1655	1504	1379	1313	1182	1118	1034
Ebonite (borracha)	95	85	76	69	64	61	55	52	48
P. V. C. e Similares	207	184	166	150	138	131	118	112	103

Serras Circulares com Dentes em Metal Duro para Alumínio e Madeira

Ø mm	R. P. M. MAX.
200	10 000
250	8 000
300	6 000
350	6 000
400	4 500
450	4 000
500	3 500
550	3 000
600	2 800



Serras Circulares com Dentes em Metal Duro para Alumínio, Madeira e seus Derivados

Material a trabalhar	m / seg
Madeira mole	60 : 90
Madeira dura	50 : 70
Contraplacado	60 : 80
Plástico	25 : 60
Alumínio	20 : 30



$$R. P. M. = \frac{V / C \times 1000}{\pi \times \varnothing}$$

N. B. Os valores fornecidos nesta tabela são orientativos

INFORMAÇÃO TÉCNICA - TABELA DO DIÂMETRO DA BROCA A UTILIZAR EM FUNÇÃO DA MEDIDA DOS MACHOS

TECHNICAL SHEET - TABLE OF DRILL DIAMETER TO BE USED AS A FUNCTION OF THE TAPS MEASUREMENT

FICHE TECHNIQUE - TABLEAU DU DIAMÈTRE DU FORET À UTILISER PAR LA MESURE DU TARAUD



Rosca Métrica Fina - MF

Ø x Passo mm	Ø Broca mm	Ø x Passo mm	Ø Broca mm
2,50 x 0,35	2,20	24,00 x 1,50	22,50
3,00 x 0,35	2,60	24,00 x 2,00	22,00
3,50 x 0,35	3,10	25,00 x 1,00	24,00
4,00 x 0,50	3,50	25,00 x 1,50	23,50
4,50 x 0,50	4,00	25,00 x 2,00	23,00
5,00 x 0,50	4,50	27,00 x 1,00	26,00
5,50 x 0,50	5,00	27,00 x 1,50	25,50
6,00 x 0,75	5,20	27,00 x 2,00	25,00
7,00 x 0,75	6,20	28,00 x 1,00	27,00
8,00 x 0,75	7,20	28,00 x 1,50	26,50
8,00 x 1,00	7,00	28,00 x 2,00	26,00
9,00 x 0,75	8,20	30,00 x 1,00	29,00
9,00 x 1,00	8,00	30,00 x 1,50	28,50
10,00 x 0,75	9,20	30,00 x 2,00	28,00
10,00 x 1,00	9,00	30,00 x 3,00	27,00
10,00 x 1,25	8,80	32,00 x 1,50	30,50
11,00 x 0,75	10,20	32,00 x 2,00	30,00
11,00 x 1,00	10,00	33,00 x 1,50	31,50
12,00 x 1,00	11,00	33,00 x 2,00	31,00
12,00 x 1,25	10,80	33,00 x 3,00	30,00
12,00 x 1,50	10,50	35,00 x 1,50	33,50
14,00 x 1,00	13,00	36,00 x 1,50	34,50
14,00 x 1,25	12,80	36,00 x 2,00	34,00
14,00 x 1,50	12,50	36,00 x 3,00	33,00
15,00 x 1,00	14,00	39,00 x 1,50	37,50
15,00 x 1,50	13,50	39,00 x 2,00	37,00
16,00 x 1,00	15,00	39,00 x 3,00	36,00
16,00 x 1,50	14,50	40,00 x 1,50	38,50
17,00 x 1,00	16,00	40,00 x 2,00	38,00
17,00 x 1,50	15,50	40,00 x 3,00	37,00
18,00 x 1,00	17,00	42,00 x 1,50	40,50
18,00 x 1,50	16,50	42,00 x 2,00	40,00
18,00 x 2,00	16,00	42,00 x 3,00	39,00
20,00 x 1,00	19,00	45,00 x 1,40	43,50
20,00 x 1,50	18,50	45,00 x 2,00	43,00
20,00 x 2,00	18,00	45,00 x 3,00	42,00
22,00 x 1,00	21,00	48,00 x 1,50	46,50
22,00 x 1,50	20,50	48,00 x 2,00	46,00
22,00 x 2,00	20,00	48,00 x 3,00	45,00
24,00 x 1,00	23,00	50,00 x 1,50	48,50

Rosca Métrica - M

Ø x Passo mm	Ø Broca mm
2,00 x 0,40	1,60
2,50 x 0,45	2,05
3,00 x 0,50	2,50
3,50 x 0,60	2,90
4,00 x 0,70	3,30
4,50 x 0,75	3,80
5,00 x 0,80	4,20
6,00 x 1,00	5,00
7,00 x 1,00	6,00
8,00 x 1,25	6,80
9,00 x 1,25	7,80
10,00 x 1,50	8,50
11,00 x 1,50	9,50
12,00 x 1,75	10,20
14,00 x 2,00	12,00
16,00 x 2,00	14,00
18,00 x 2,50	15,50
20,00 x 2,50	17,50
22,00 x 2,50	19,50
24,00 x 3,00	21,00
27,00 x 3,00	24,00
30,00 x 3,50	26,50
33,00 x 3,50	29,50
36,00 x 4,00	32,00
39,00 x 4,00	35,00
42,00 x 4,50	37,50

Rosca BSPT "Gás Cônica"

Ø x Passo f/1" polegadas	Min T1 mm	D1 mm	D2 mm	D3 mm
1/8 x 28	12,00	7,70	7,50	8,57
1/4 x 19	16,50	11,00	10,80	11,44
3/8 x 19	17,50	14,60	14,30	14,95
1/2 x 14	21,50	18,20	17,80	18,63
5/8 x 14	21,50	20,20	19,80	20,59
3/4 x 14	24,00	23,40	22,90	24,12
7/8 x 14	25,50	30,10	26,60	27,87
1" x 11	27,00	30,40	29,10	30,29

N. B. Os valores fornecidos nesta tabela são orientativos

INFORMAÇÃO TÉCNICA - TABELA DO DIÂMETRO DA BROCA A UTILIZAR EM FUNÇÃO DA MEDIDA DOS MACHOS

TECHNICAL SHEET - TABLE OF DRILL DIAMETER TO BE USED AS A FUNCTION OF THE TAPS MEASUREMENT

FICHE TECHNIQUE - TABLEAU DU DIAMÈTRE DU FORET À UTILISER PAR LA MESURE DU TARAUD

Rosca BSF

Ø x Passo f/1" polegadas	Ø Broca mm
3/16 x 32	4,00
7/32 x 28	4,70
1/4 x 26	5,40
9/32 x 26	6,20
5/16 x 22	6,80
3/8 x 20	8,30
7/16 x 18	9,80
1/2 x 16	11,20
9/16 x 16	12,70
5/8 x 14	14,00
11/16 x 14	15,70
3/4 x 12	17,00
13/16 x 12	18,50
7/8 x 11	20,00
1" x 10	23,00
1"1/8 x 9	26,00
1"1/4 x 9	29,00
1"3/8 x 8	32,00
1"1/2 x 8	35,00
1"5/8 x 8	38,00
1"3/4 x 7	40,50
2" x 7	47,00
2"1/4 x 6	52,50
2"1/2 x 6	59,00

Rosca BSW "Whitworth"

Ø x Passo f/1" polegadas	Ø Broca mm
1/8 x 40	2,60
5/32 x 32	3,10
3/16 x 24	3,60
7/32 x 24	4,40
1/4 x 20	5,10
5/16 x 18	6,50
3/8 x 16	7,90
7/16 x 14	9,30
1/2 x 12	10,50
9/16 x 12	12,00
5/8 x 11	13,50
3/4 x 10	16,50
7/8 x 9	19,25
1" x 8	22,00
1"1/8 x 7	24,75
1"1/4 x 7	27,75
1"3/8 x 6	30,50
1"1/2 x 6	33,50
1"5/8 x 5	35,50
1"3/4 x 5	39,00
1"7/8 x 4,5	41,50
2" x 4,5	44,50
2"1/4 x 4	50,00
2"1/2 x 4	56,50

Rosca BSP "Gás"

Ø x Passo f/1" polegadas	Ø Broca mm
1/8 x 28	8,80
1/4 x 19	11,80
3/8 x 19	15,25
1/2 x 14	19,00
5/8 x 14	21,60
3/4 x 14	24,50
7/8 x 14	28,25
1" x 11	30,75
1"1/8 x 11	35,50
1"1/4 x 11	39,50
1"3/8 x 11	42,00
1"1/2 x 11	45,50
1"5/8 x 11	49,60
1"3/4 x 11	51,40
2" x 11	57,20
2"1/4 x 11	63,30
2"3/8 x 11	67,00
2"1/2 x 11	72,80
2"3/4 x 11	79,10
3" x 11	85,50
3"1/4 x 11	91,50
3"1/2 x 11	98,00
3"3/4 x 11	104,00
4" x 11	110,50

Rosca UNC

Ø x Passo f/1" polegadas	Ø Broca mm
Nr 1 x 64	1,50
Nr 2 x 56	1,80
Nr 3 x 48	2,10
Nr 4 x 40	2,30
Nr 5 x 40	2,60
Nr 6 x 32	2,80
Nr 7 x 32	3,50
Nr 10 x 24	3,90
Nr 12 x 24	4,50
1/4 x 20	5,20
5/16 x 18	6,60
3/8 x 16	8,00
7/16 x 14	9,40
1/2 x 13	10,75
9/16 x 12	12,25
5/8 x 11	13,50
3/4 x 10	16,50
7/8 x 9	19,50
1" x 8	22,25
1"1/8 x 7	25,00
1"1/4 x 7	28,25
1"3/8 x 6	30,75
1"1/2 x 6	34,00
1"3/4 x 5	39,50
2" x 4"1/2	45,25
2"1/4 x 4"1/2	51,50
2"1/2 x 4"1/2	57,25

Rosca NPT

Ø x Passo f/1" polegadas	Min T1 mm	D1 mm	D2 mm	D3 mm
1/16 x 27	12,00	6,20	6,00	6,39
1/8 x 27	12,00	8,50	8,30	8,74
1/4 x 18	17,50	11,00	10,70	11,36
3/8 x 18	17,60	14,50	14,20	14,80
1/2 x 14	22,90	17,80	17,40	18,32
3/4 x 14	23,00	23,00	22,50	23,67
1" x 11,5	27,40	29,00	28,50	29,69
1"1/4 x 11,5	28,00	28,00	37,50	38,45
1"1/2 x 11,5	28,40	28,40	44,00	44,52
2" x 11,5	28,00	28,00	56,00	56,56
2"1/2 x 8	40,80	66,50	66,00	67,62
3" x 8	43,00	43,00	82,50	83,53
3"1/2 x 8	44,50	44,50	95,00	96,24
4" x 8	45,50	107,70	107,20	108,89



N. B. Os valores fornecidos nesta tabela são orientativos

INFORMAÇÃO TÉCNICA - TABELA DO DIÂMETRO DA BROCA A UTILIZAR EM RELAÇÃO ÀS DIMENSÕES DA ROSCA A REPARAR

TECHNICAL SHEET - DRILL DIAMETER CHART TO USE IN RELATION TO THREAD DIMENSIONS TO REPAIR

FICHE TECHNIQUE - TABLEAU DES DIAMÈTRES DE FORAGE À UTILISER PAR RAPPORT AUX DIMENSIONS DE FILETAGE

Rosca Métrica e Métrica Fina

Ø Rosca mm	Ø Broca mm
M 2 x 0,40	2,10
M 2,2 x 0,45	2,30
M 2,5 x 0,45	2,60
M 3 x 0,50	3,20
M 3,5 x 0,60	3,70
M 4 x 0,70	4,20
M 5 x 0,80	5,20
M 6 x 1,00	6,30
M 7 x 1,00	7,30
M 8 x 1,25	8,30
M 8 x 1,00	8,30
M 9 x 1,25	9,30
M 10 x 1,50	10,40
M 10 x 1,25	10,30
M 10 x 1,00	10,30
M 11 x 1,50	11,40
M 12 x 1,75	12,40
M 12 x 1,50	12,40
M 12 x 1,25	12,30
M 12 x 1,00	12,30
M 14 x 2,00	14,50
M 14 x 1,50	14,40
M 14 x 1,25	14,40
M 14 x 1,00	14,30
M 16 x 2,00	16,50
M 16 x 1,50	16,40
M 18 x 2,50	18,60
M 18 x 2,00	18,50
M 18 x 1,50	18,50
M 20 x 2,50	20,60
M 20 x 2,00	20,50
M 20 x 1,50	20,50
M 22 x 2,50	22,60
M 22 x 2,00	22,50
M 22 x 1,50	22,50
M 24 x 3,00	24,75
M 24 x 2,00	24,50
M 24 x 1,50	24,50
M 26 x 1,50	26,50
M 27 x 3,00	27,75
M 27 x 2,00	27,50
M 27 x 1,50	27,50
M 28 x 1,50	28,50
M 30 x 3,50	31,00
M 30 x 2,00	30,50
M 30 x 1,50	30,50
M 33 x 3,50	34,00
M 33 x 2,00	33,50
M 36 x 4,00	37,00
M 36 x 3,00	37,00
M 36 x 2,00	36,50
M 36 x 1,50	36,50



Rosca UNF

Ø Rosca mm	Ø Broca mm
8 x 36	4,40
10 x 32	5,10
1/4 x 28	6,60
5/16 x 24	8,20
3/8 x 24	9,80
7/16 x 20	11,50
1/2 x 20	13,00
9/16 x 18	14,80
5/8 x 18	16,25
3/4 x 16	19,50
7/8 x 14	22,75
1" x 12	26,00
1"1/8 x 12	29,00
1"1/4 x 12	32,50
1"1/2 x 12	38,50

Rosca BSF

Ø Rosca mm	Ø Broca mm
3/16 x 32	5,00
1/4 x 26	6,60
5/16 x 22	8,30
3/8 x 20	9,90
7/16 x 18	11,60
1/2 x 16	13,00
9/16 x 16	14,80
5/8 x 14	16,40
3/4 x 12	19,50
7/8 x 11	22,70
1" x 10	26,50

N. B. Os valores fornecidos nesta tabela são orientativos

INFORMAÇÃO TÉCNICA - TABELA DO DIÂMETRO DA BROCA A UTILIZAR EM RELAÇÃO ÀS DIMENSÕES DA ROSCA A REPARAR

TECHNICAL SHEET - DRILL DIAMETER CHART TO USE IN RELATION TO THREAD DIMENSIONS TO REPAIR

FICHE TECHNIQUE - TABLEAU DES DIAMÈTRES DE FORAGE À UTILISER PAR RAPPORT AUX DIMENSIONS DE FILETAGE

Rosca BSP

Ø Rosca mm			Ø Broca mm
1/8	x	28	10,00
1/4	x	19	13,60
3/8	x	19	17,10
1/2	x	14	21,50
5/8	x	14	23,40
3/4	x	14	27,00
7/8	x	14	30,60
1"	x	11	33,70



Rosca UNC

Ø Rosca mm			Ø Broca mm
8	x	32	4,40
10	x	24	5,10
12	x	24	5,70
1/4	x	20	6,70
5/16	x	18	8,30
3/8	x	16	9,90
7/16	x	14	11,60
1/2	x	13	13,00
9/16	x	12	14,80
5/8	x	11	16,50
3/4	x	10	19,75
7/8	x	9	23,00
1"	x	8	26,25
1"1/8	x	7	29,50
1"1/4	x	7	33,00
1"1/2	x	6	39,50

Rosca BSW

Ø Rosca mm			Ø Broca mm
1/8	x	40	3,40
3/16	x	24	5,10
1/4	x	20	6,70
5/16	x	18	8,30
3/8	x	16	9,90
7/16	x	14	11,60
1/2	x	12	13,00
9/16	x	12	14,80
5/8	x	11	16,70
3/4	x	10	20,00
7/8	x	9	23,00
1"	x	8	26,50

N. B. Os valores fornecidos nesta tabela são orientativos

CONDIÇÕES GERAIS DE VENDA

GENERAL SALES CONDITIONS
CONDITIONS GÉNÉRALES DE VENTE

1. Preços

Os preços serão os que estiverem em vigor à data do fornecimento, estes podem ser alterados sem qualquer aviso prévio.

2. Descontos Comerciais

De acordo com o acordado no ato da venda ou conforme oferta.

3. Imposto sobre o Valor Acrescentado

Não incluído nas nossas tabelas e aplicável de acordo com a taxa em vigor.

4. Expedição

4.1. Material/Ferramentas

- * O valor do transporte é cobrado em encomendas inferiores a 150€ líquidos.
- * As encomendas expedidas à cobrança, de valor inferior a 250€ líquidos, será cobrado um custo de transporte adicional.

4.2. Serviços de Afiação

- * O valor do transporte é cobrado em serviços inferiores a 50€ líquidos.
- * Nas expedições à cobrança de valor inferior a 100€ líquidos, será cobrado um custo de transporte adicional

5. Risco das Mercadorias

As mercadorias viajam por conta e risco do cliente desde a descarga dos nossos meios de transporte.

6. Faturação

Poderão ser debitados fornecimentos parciais com valores inferiores aos mínimos estabelecidos, se o pedido total for superior e o fornecimento parcial resultar da falta momentânea de artigos.

7. Pagamento

Faturas a pronto pagamento - 2% desconto

Faturas a 8 dias do nosso resumo mensal - 2% desconto

Faturas a 30 dias do nosso resumo mensal - 1% desconto

O pagamento de materiais encomendado especialmente será conforme o acordado na data de encomenda.

Para transferências bancárias: **IBAN do MILLENNIUM** PT50 0033 0000 4543 9051 1230 5

IBAN do NOVO BANCO PT50 0007 0000 0043 1892 5982 3

8. Fornecimentos Parciais

Quando não especificamente estipulado o contrário, reservamo-nos ao direito de efetuar fornecimentos parciais.

9. Prazos de Entrega

Os prazos de entrega oferecidos poderão ser alterados por motivos de força maior.

10. Discrepâncias no Fornecimento

No caso da mercadoria fornecida não corresponder ao constante na guia de remessa, deverá ser feita menção desse facto na própria guia de remessa.

11. Alterações no Catálogo/Preçário

Este Catálogo/Preçário poderá sofrer alterações sem qualquer aviso prévio.

CONDIÇÕES GERAIS DE VENDA

GENERAL SALES CONDITIONS

CONDITIONS GÉNÉRALES DE VENTE

12. Política de Devoluções

A política de devoluções da MF Martins é aplicada a todos os nossos clientes, nos produtos comercializados pela empresa, sendo a origem da compra em loja física ou online. Esta Política é uma diretriz sobre como pode devolver os produtos em caso de livre resolução.

O prazo para devolução do produto é de até 14 dias a partir da data de entrega. O pedido de devolução deve ser realizado no próprio documento de transporte do artigo, sendo obrigatório constar o número da fatura correspondente, a referência do material e o motivo da devolução. Os custos associados ao transporte do produto ficam a cargo do cliente.

Além do cumprimento dos prazos e envio das informações necessárias, a devolução deve apresentar as seguintes condições:

- O produto tem de ser entregue em caixa de origem, em bom estado e completo, nas mesmas condições em que foi entregue, com todos os acessórios incluídos;
- O produto não pode apresentar sinais de utilização;

É importante referir que não serão aceites devoluções de produtos de fabrico especial.

No caso de erro por parte do cliente, o crédito a efetuar terá um desconto de 20% em relação ao preço de venda, sendo o prazo de 14 dias da entrega do produto ultrapassado. Caso o artigo a ser devolvido tenha sido comprado no âmbito de uma campanha, em que o consumidor tenha sido beneficiado com descontos, o valor deste será deduzido na nota de crédito.

13. Política de Garantias

A política de garantias da MF Martins é aplicada a todos os nossos clientes, nos produtos comercializados pela empresa, sendo a origem da compra em loja física ou online. Esta Política é uma diretriz sobre como pode reclamar os produtos em caso destes apresentarem defeitos.

No âmbito das garantias, deve solicitar a resolução da situação através do Formulário de Reclamação de Produto, desde que o pedido seja feito dentro de 30 dias após a entrega. O pedido de garantia deve ser realizado através do envio do formulário para o email qualidade@mfmartins.pt.

Apenas serão avaliados os produtos com o Formulário preenchido e enviado. Os custos associados ao transporte do produto ficam a cargo do cliente.

Esta política de garantia não cobre defeitos e danos resultantes de:

- Utilização e desgaste normal do equipamento ou de outra forma devido ao normal envelhecimento do equipamento;
- Utilização do produto para além do que é indicado e de forma habitual;
- Utilização indevida, abusiva, negligente ou acidente causado de qualquer forma;