



CATÁLOGO / PREÇÁRIO GERAL

COMO CONSULTAR A NOSSA TABELA DE PREÇOS

Os nossos produtos estão divididos nos seguintes grupos:

GRUPO N.º	DESCRIÇÃO
Grupo 1	Parafusos para a indústria
Grupo 2	Parafusos para a construção
Grupo 3	Parafusos para a indústria da madeira
Grupo 4	Porcas e anilhas
Grupo 5	Freios, golpilhas e cavilhas
Grupo 6	Rebites
Grupo 7	Buchas - fixação
*Grupo 8	Químicos (silicones, resinas e sprays)
Grupo 9	Correntes, cabos e acessórios
*Grupo 10	Soldadura
Grupo 11	Consumíveis (brocas, discos, etc...)
Grupo 12	Ferramentas manuais
*Grupo 13	Abraçadeiras
*Grupo 14	Equipamentos de Protecção Individual

O ÍNDICE

Designação da família do produto

Imagem do produto

Localização da tabela de preços do produto por material e acabamento

Imagem do produto

A TABELA DE PREÇOS

Designação do produto

Informação sobre materiais e acabamentos disponíveis

PORCAS SEXTAVADAS DIN 934, BS 1033

BROCHE
ROSCA CLASSE 10 - PRETO, ZINCO
SISTEMA PAIRO

M	AÇO CLASSE 10 - PRETO, ZINCO		AÇO INOX		M	AÇO INOX	
	PRETO	ZINCO	A2	A4		PRETO	ZINCO
M3	0,33	0,34	1,88	1,98	M3	0,33	0,34
M4	0,44	0,45	2,55	2,65	M4	0,44	0,45
M5	0,55	0,56	3,22	3,32	M5	0,55	0,56
M6	0,66	0,67	3,89	3,99	M6	0,66	0,67
M8	0,88	0,89	5,15	5,25	M8	0,88	0,89
M10	1,10	1,11	6,41	6,51	M10	1,10	1,11
M12	1,32	1,33	7,67	7,77	M12	1,32	1,33
M16	1,76	1,77	10,23	10,33	M16	1,76	1,77
M20	2,20	2,21	12,79	12,89	M20	2,20	2,21
M24	2,64	2,65	15,35	15,45	M24	2,64	2,65
M30	3,30	3,31	19,75	19,85	M30	3,30	3,31
M36	3,96	3,97	23,15	23,25	M36	3,96	3,97
M42	4,62	4,63	27,55	27,65	M42	4,62	4,63
M48	5,28	5,29	31,95	32,05	M48	5,28	5,29
M56	6,16	6,17	37,15	37,25	M56	6,16	6,17
M64	7,04	7,05	42,35	42,45	M64	7,04	7,05
M72	7,92	7,93	47,55	47,65	M72	7,92	7,93
M80	8,80	8,81	52,75	52,85	M80	8,80	8,81
M90	9,90	9,91	59,45	59,55	M90	9,90	9,91
M100	11,00	11,01	66,15	66,25	M100	11,00	11,01
M110	12,10	12,11	72,85	72,95	M110	12,10	12,11
M120	13,20	13,21	79,55	79,65	M120	13,20	13,21
M140	15,40	15,41	94,75	94,85	M140	15,40	15,41
M160	17,60	17,61	109,95	110,05	M160	17,60	17,61
M180	19,80	19,81	125,15	125,25	M180	19,80	19,81
M200	22,00	22,01	140,35	140,45	M200	22,00	22,01
M220	24,20	24,21	155,55	155,65	M220	24,20	24,21
M240	26,40	26,41	170,75	170,85	M240	26,40	26,41
M270	30,24	30,25	198,35	198,45	M270	30,24	30,25
M300	34,08	34,09	225,95	226,05	M300	34,08	34,09
M360	40,32	40,33	271,15	271,25	M360	40,32	40,33
M420	46,56	46,57	316,35	316,45	M420	46,56	46,57
M480	52,80	52,81	361,55	361,65	M480	52,80	52,81
M560	60,48	60,49	412,35	412,45	M560	60,48	60,49
M640	68,16	68,17	463,15	463,25	M640	68,16	68,17
M720	75,84	75,85	513,95	514,05	M720	75,84	75,85
M800	83,52	83,53	564,75	564,85	M800	83,52	83,53
M900	93,60	93,61	621,15	621,25	M900	93,60	93,61
M1000	103,68	103,69	677,55	677,65	M1000	103,68	103,69

Divisão da tabela por materiais e acabamentos

Utilizamos nas nossas tabelas o seguinte código de cores correspondente a cada material ou classe de resistência:

Cor	Parafusos	Porcas	Dureza	Buchas (cargas)
Amarelo	4,8	CL6	100 HV	Médias
Verde	8,8	CL8	200 HV	Altas
Vermelho	10,9	CL10	>300 HV	Elevadas
Verde claro	Aço cementado			
Verde escuro	Aço Inox AISI 304 (A2)			
Verde muito escuro	Aço Inox AISI 316 (A4)			
Amarelo claro	Latão, cobre			
Amarelo escuro	Alumínio			

Informação sobre a edição e revisões da tabela e respectivas datas

Unidade preço

Desconto

Numeração da tabela por grupos

PORCAS DE MAMA DIN 1547, DIN 1547 SW

SISTEMA PAIRO
SISTEMA HANDELAB
ROSCA INOX-A2, A4

M	LATÃO		AÇO INOX		M	LATÃO	
	POLIDO	NICKELADO	A2	A4		POLIDO	NICKELADO
M3	3,44	3,44	3,44	3,44	M3	3,44	3,44
M4	4,59	4,59	4,59	4,59	M4	4,59	4,59
M5	5,74	5,74	5,74	5,74	M5	5,74	5,74
M6	6,89	6,89	6,89	6,89	M6	6,89	6,89
M8	9,15	9,15	9,15	9,15	M8	9,15	9,15
M10	11,41	11,41	11,41	11,41	M10	11,41	11,41
M12	13,67	13,67	13,67	13,67	M12	13,67	13,67
M16	18,23	18,23	18,23	18,23	M16	18,23	18,23
M20	22,79	22,79	22,79	22,79	M20	22,79	22,79
M24	27,35	27,35	27,35	27,35	M24	27,35	27,35
M30	34,19	34,19	34,19	34,19	M30	34,19	34,19
M36	41,03	41,03	41,03	41,03	M36	41,03	41,03
M42	47,87	47,87	47,87	47,87	M42	47,87	47,87
M48	54,71	54,71	54,71	54,71	M48	54,71	54,71
M56	61,55	61,55	61,55	61,55	M56	61,55	61,55
M64	68,39	68,39	68,39	68,39	M64	68,39	68,39
M72	75,23	75,23	75,23	75,23	M72	75,23	75,23
M80	82,07	82,07	82,07	82,07	M80	82,07	82,07
M90	89,91	89,91	89,91	89,91	M90	89,91	89,91
M100	97,75	97,75	97,75	97,75	M100	97,75	97,75
M110	105,59	105,59	105,59	105,59	M110	105,59	105,59
M120	113,43	113,43	113,43	113,43	M120	113,43	113,43
M140	131,03	131,03	131,03	131,03	M140	131,03	131,03
M160	148,63	148,63	148,63	148,63	M160	148,63	148,63
M180	166,23	166,23	166,23	166,23	M180	166,23	166,23
M200	183,83	183,83	183,83	183,83	M200	183,83	183,83
M220	201,43	201,43	201,43	201,43	M220	201,43	201,43
M240	219,03	219,03	219,03	219,03	M240	219,03	219,03
M270	250,23	250,23	250,23	250,23	M270	250,23	250,23
M300	281,43	281,43	281,43	281,43	M300	281,43	281,43
M360	337,83	337,83	337,83	337,83	M360	337,83	337,83
M420	394,23	394,23	394,23	394,23	M420	394,23	394,23
M480	450,63	450,63	450,63	450,63	M480	450,63	450,63
M560	507,03	507,03	507,03	507,03	M560	507,03	507,03
M640	563,43	563,43	563,43	563,43	M640	563,43	563,43
M720	619,83	619,83	619,83	619,83	M720	619,83	619,83
M800	676,23	676,23	676,23	676,23	M800	676,23	676,23
M900	732,63	732,63	732,63	732,63	M900	732,63	732,63
M1000	789,03	789,03	789,03	789,03	M1000	789,03	789,03

Código: 12118 Revisão: 1 Preço: 27000 Data: 2023-05-15 Tabela 03



GRUPO 1 PARAFUSOS PARA A INDÚSTRIA

ÍNDICE 1.1

VARÃO ROSCADO DIN 975					CHUMBADOUROS "L"					GRAMPOS DIREITOS M6 E ACESSÓRIOS					PARAFUSOS SEXTAVADOS DIN 558						
Grupo: 1					Grupo: 1					Grupo: 1					Grupo: 1						
		4,8	8,8	A2		A4		4,8	8,8								4,8				
	PRETO	T1.1	T1.1			T1.1	PRETO					ZINCADO	T1.3	ALU		A2		PRETO	T1.4		
ZINCADO	T1.1	T1.1	T1.1	T1.1	ZINCADO	T1.1A	T1.1A					T1.3	T1.3	ZINCADO	T1.4						
GALV. Q.		T1.1																			

PARAFUSOS SEXTAVADOS DIN 933					PARAFUSOS SEXTAVADOS DIN 931					PARAFUSOS TIREFONDS DIN 571					PARAF. CAB. OVAL E QUADRA DIN 603						
Grupo: 1					Grupo: 1					Grupo: 1					Grupo: 1						
		8,8	10,9	A2		A4		8,8	10,9		A2	A4		4,8		A2		4,8	A2		
	PRETO	T1.5	T1.6			T1.7	PRETO	T1.8	T1.9			T1.10	ZINCADO	T1.11				ZINCADO	T1.11		
ZINCADO	T1.5	T1.6	T1.7	T1.7	ZINCADO	T1.8A	T1.9	T1.10	T1.10			T1.11				T1.11					
GALV. Q.	T1.6																				

PARAF. ^{OS} CABEÇA CILÍNDRICA DIN 912					PARAF. ^{OS} CABEÇA CHATA DIN 7991					PARAF. ^{OS} CABEÇA OVAL ISO 7380					PERNOS ROSCADOS DIN 916 - ISO 4029					
Grupo: 1					Grupo: 1					Grupo: 1					Grupo: 1					
		8,8	12,9	A2		A4		10,9	A2		A4		10,9	A2			45H	A2		
	PRETO	T1.12	T1.12			T1.13	PRETO	T1.14			T1.15	PRETO	T1.16				PRETO	T1.17		
ZINCADO	T1.12		T1.13	T1.13	ZINCADO	T1.14	T1.15	T1.15	ZINCADO	T1.16	T1.16					T1.17				





PERNOS ROSCADOS DIN 914 - ISO 4027					CHAVES SEXTAV. "UMBRAKO" DIN 911					PARAF. ^{OS} ROSCA DE METAIS DIN 84					PARAF. ^{OS} ROSCA DE METAIS DIN 963				
Grupo: 1					Grupo: 1					Grupo: 1					Grupo: 1				
		45H	A2				ZINCADAS		4,8		A2		4,8	A2					
	PRETO	T1.17 A		T1.17 A				T1.17 A	ZINCADO		T1.18	T1.18	ZINCADO	T1.18		T1.18			





PARAF. ^{OS} ROSCA DE METAIS DIN 965					PARAF. ^{OS} ROSCA DE METAIS DIN 7985															
Grupo: 1					Grupo: 1															
		4,8	A2				4,8	A2												
	ZINCADO	T1.18	T1.18			ZINCADO	T1.18	T1.18												











GRUPO 2 PARAFUSOS PARA A CONSTRUÇÃO







ÍNDICE 2.1

PARAF. ^{OS} AUTORROSCANTES DIN 7981	PARAF. ^{OS} AUTORROSCANTES DIN 7982	PARAF. ^{OS} AÇO FOSFATADO PARA PLADUR	PARAF. ^{OS} AUTOPERFORANTES AÇO FOSFATADO P/ PLADUR
 Grupo: 2	 Grupo: 2	 Grupo: 2	 Grupo: 2
ZINCADO AÇO A2 T2.1 T2.1 Zincagem Cr3+ de acordo com RoHS	ZINCADO AÇO A2 T2.1 T2.1 Zincagem Cr3+ de acordo com RoHS	FOSFAT. AÇO T2.2	FOSFAT. AÇO T2.2

PARAF. ^{OS} AUTORROSCANTES CAB. SEXT. C/ ANILHA FALSA	PARAF. ^{OS} AUTORROSCANTES CAB. SEXT. C/ ANILHA FALSA	PARAF. ^{OS} AUTOPERFORANTES DIN 7504-K	PARAF. ^{OS} AUTOPERFORANTES DIN 7504-K (C/ ANILHA EPDM)
 Grupo: 2	MONTADO C/ EPDM Ø16-Ø19-Ø25  Grupo: 2	 Grupo: 2	 Grupo: 2
ZINCADO AÇO T2.2	ZINCADO AÇO T2.2	ZINCADO AÇO A2 T2.2A T2.2A	ZINCADO AÇO T2.2A

TAMPAS EM NYLON SEXT. 8 e SEXT. 10	PARAF. ^{OS} AUTOPERFORANTES CAB. SEXTAV. EM NYLON	PARAF. ^{OS} AUTOPERFORANTES PARA PAINEL SANDWICH	PARAF. ^{OS} AUTOPERFORANTES PARA PAINEL SANDWICH COM ANILHA EPDM
 Grupo: 2	 Grupo: 2	 Grupo: 2	 Grupo: 2
NYLON - TODAS AS CORES T2.2A	ZINCADO AÇO T2.3 CABEÇA EM NYLON TODAS AS CORES	ZINCADO AÇO T2.3	ZINCADO AÇO T2.3

PARAF. ^{OS} AUTOPERFORANTES PARA PAINEL SANDWICH	PARAF. ^{OS} AUTOPERFORANTES CAB. QUEIJO - DIN 7504-N	PARAF. ^{OS} AUTOPERFORANTES CAB. CHATA - DIN 7504-P	PARAF. ^{OS} AUTOPERFORANTES PARA VIGAS
CABEÇA SEXT. NYLON INJECTADO  Grupo: 2	 Grupo: 2	 Grupo: 2	 Grupo: 2
ZINCADO AÇO T2.3	ZINCADO AÇO A2 T2.3A T2.3A	ZINCADO AÇO A2 T2.3A T2.3A	ZINCADO AÇO T2.4

PARAF. ^{OS} AUTOPERFORANTES PARA VIGAS COM ANILHA EPDM	PARAF. ^{OS} AUTOPERFORANTES CABEÇA LARGA - PHILIPS	PARAF. ^{OS} AUTOPERFORANTES PARA CARROCERIAS - PHILIPS	PARAF. ^{OS} AUTOPERFORANTES PARA CARROCERIAS - TORX
 Grupo: 2	  Grupo: 2	  Grupo: 2	  Grupo: 2
ZINCADO AÇO T2.3	ZINCADO AÇO T2.4	ZINCADO AÇO T2.4	ZINCADO AÇO T2.4



GRUPO 2 PARAFUSOS PARA A CONSTRUÇÃO

ÍNDICE 2.2

PARAFUSO ESPECIAL PARA ROSCAR NO BETÃO	PARAF. ^{OS} AUTOPERFURANTES SEXTAVADOS - PONTA REDUZIDA	PARAF. ^{OS} AUTOPERFURANTES SEXTAVADOS - PONTA REDUZIDA	PARAF. ^{OS} AUTOPERFURANTES SEXTAVADOS - PONTA REDUZIDA																																								
<p>Grupo: 2</p>	<p>ENTRE FACES 10 mm</p> <p>SIMPLES</p>	<p>ENTRE FACES 10 mm</p> <p>COM ANILHA EPDM</p>	<p>ENTRE FACES 8 mm</p> <p>SIMPLES</p>																																								
<table border="1" style="width: 100%; border-collapse: collapse;"> <tr><td style="width: 20%;">AÇO</td><td style="width: 20%;"></td><td style="width: 20%;"></td><td style="width: 20%;"></td><td style="width: 20%;"></td></tr> <tr><td>BLUE RUSPERT</td><td>T2.4</td><td></td><td></td><td></td></tr> </table>	AÇO					BLUE RUSPERT	T2.4				<table border="1" style="width: 100%; border-collapse: collapse;"> <tr><td style="width: 20%;">AÇO</td><td style="width: 20%;"></td><td style="width: 20%;"></td><td style="width: 20%;"></td><td style="width: 20%;"></td></tr> <tr><td>ZINCADO</td><td>T2.5</td><td></td><td></td><td></td></tr> </table>	AÇO					ZINCADO	T2.5				<table border="1" style="width: 100%; border-collapse: collapse;"> <tr><td style="width: 20%;">AÇO</td><td style="width: 20%;"></td><td style="width: 20%;"></td><td style="width: 20%;"></td><td style="width: 20%;"></td></tr> <tr><td>ZINCADO</td><td>T2.5</td><td></td><td></td><td></td></tr> </table>	AÇO					ZINCADO	T2.5				<table border="1" style="width: 100%; border-collapse: collapse;"> <tr><td style="width: 20%;">AÇO</td><td style="width: 20%;"></td><td style="width: 20%;"></td><td style="width: 20%;"></td><td style="width: 20%;"></td></tr> <tr><td>ZINCADO</td><td>T2.5</td><td></td><td></td><td></td></tr> </table>	AÇO					ZINCADO	T2.5			
AÇO																																											
BLUE RUSPERT	T2.4																																										
AÇO																																											
ZINCADO	T2.5																																										
AÇO																																											
ZINCADO	T2.5																																										
AÇO																																											
ZINCADO	T2.5																																										

PARAF. ^{OS} AUTOPERFURANTES SEXTAVADOS - PONTA REDUZIDA	PARAF. ^{OS} AUTOPERFURANTES PARA FIBROCIMENTO	PARAF. ^{OS} AUTOPERFURANTES PHILIPS - PARA ISOLAMENTOS	ANILHAS DE CHAPA PARA ISOLAMENTOS																																								
<p>Grupo: 2</p> <p>ENTRE FACES 8 mm</p> <p>COM ANILHA EPDM</p>	<p>Grupo: 2</p> <p>COM ANILHA GUARDA-CHUVA</p>	<p>Grupo: 2</p> <p>(COBERTURAS DECK)</p>	<p>Grupo: 2</p> <p>(COBERTURAS DECK)</p>																																								
<table border="1" style="width: 100%; border-collapse: collapse;"> <tr><td style="width: 20%;">AÇO</td><td style="width: 20%;"></td><td style="width: 20%;"></td><td style="width: 20%;"></td><td style="width: 20%;"></td></tr> <tr><td>ZINCADO</td><td>T2.5</td><td></td><td></td><td></td></tr> </table>	AÇO					ZINCADO	T2.5				<table border="1" style="width: 100%; border-collapse: collapse;"> <tr><td style="width: 20%;">AÇO</td><td style="width: 20%;"></td><td style="width: 20%;"></td><td style="width: 20%;"></td><td style="width: 20%;"></td></tr> <tr><td>ZINCADO</td><td>T2.5</td><td></td><td></td><td></td></tr> </table>	AÇO					ZINCADO	T2.5				<table border="1" style="width: 100%; border-collapse: collapse;"> <tr><td style="width: 20%;">AÇO</td><td style="width: 20%;"></td><td style="width: 20%;"></td><td style="width: 20%;"></td><td style="width: 20%;"></td></tr> <tr><td>ZINCADO</td><td>T2.5</td><td></td><td></td><td></td></tr> </table>	AÇO					ZINCADO	T2.5				<table border="1" style="width: 100%; border-collapse: collapse;"> <tr><td style="width: 20%;">ALUZINC</td><td style="width: 20%;"></td><td style="width: 20%;"></td><td style="width: 20%;"></td><td style="width: 20%;"></td></tr> <tr><td></td><td>T2.5</td><td></td><td></td><td></td></tr> </table>	ALUZINC						T2.5			
AÇO																																											
ZINCADO	T2.5																																										
AÇO																																											
ZINCADO	T2.5																																										
AÇO																																											
ZINCADO	T2.5																																										
ALUZINC																																											
	T2.5																																										

<table border="1" style="width: 100%; border-collapse: collapse;"> <tr><td style="width: 20%;"></td><td style="width: 20%;"></td><td style="width: 20%;"></td><td style="width: 20%;"></td><td style="width: 20%;"></td></tr> <tr><td></td><td></td><td></td><td></td><td></td></tr> </table>											<table border="1" style="width: 100%; border-collapse: collapse;"> <tr><td style="width: 20%;"></td><td style="width: 20%;"></td><td style="width: 20%;"></td><td style="width: 20%;"></td><td style="width: 20%;"></td></tr> <tr><td></td><td></td><td></td><td></td><td></td></tr> </table>											<table border="1" style="width: 100%; border-collapse: collapse;"> <tr><td style="width: 20%;"></td><td style="width: 20%;"></td><td style="width: 20%;"></td><td style="width: 20%;"></td><td style="width: 20%;"></td></tr> <tr><td></td><td></td><td></td><td></td><td></td></tr> </table>											<table border="1" style="width: 100%; border-collapse: collapse;"> <tr><td style="width: 20%;"></td><td style="width: 20%;"></td><td style="width: 20%;"></td><td style="width: 20%;"></td><td style="width: 20%;"></td></tr> <tr><td></td><td></td><td></td><td></td><td></td></tr> </table>										









<table border="1" style="width: 100%; border-collapse: collapse;"> <tr><td style="width: 20%;"></td><td style="width: 20%;"></td><td style="width: 20%;"></td><td style="width: 20%;"></td><td style="width: 20%;"></td></tr> <tr><td></td><td></td><td></td><td></td><td></td></tr> </table>											<table border="1" style="width: 100%; border-collapse: collapse;"> <tr><td style="width: 20%;"></td><td style="width: 20%;"></td><td style="width: 20%;"></td><td style="width: 20%;"></td><td style="width: 20%;"></td></tr> <tr><td></td><td></td><td></td><td></td><td></td></tr> </table>											<table border="1" style="width: 100%; border-collapse: collapse;"> <tr><td style="width: 20%;"></td><td style="width: 20%;"></td><td style="width: 20%;"></td><td style="width: 20%;"></td><td style="width: 20%;"></td></tr> <tr><td></td><td></td><td></td><td></td><td></td></tr> </table>											<table border="1" style="width: 100%; border-collapse: collapse;"> <tr><td style="width: 20%;"></td><td style="width: 20%;"></td><td style="width: 20%;"></td><td style="width: 20%;"></td><td style="width: 20%;"></td></tr> <tr><td></td><td></td><td></td><td></td><td></td></tr> </table>										





<table border="1" style="width: 100%; border-collapse: collapse;"> <tr><td style="width: 20%;"></td><td style="width: 20%;"></td><td style="width: 20%;"></td><td style="width: 20%;"></td><td style="width: 20%;"></td></tr> <tr><td></td><td></td><td></td><td></td><td></td></tr> </table>											<table border="1" style="width: 100%; border-collapse: collapse;"> <tr><td style="width: 20%;"></td><td style="width: 20%;"></td><td style="width: 20%;"></td><td style="width: 20%;"></td><td style="width: 20%;"></td></tr> <tr><td></td><td></td><td></td><td></td><td></td></tr> </table>											<table border="1" style="width: 100%; border-collapse: collapse;"> <tr><td style="width: 20%;"></td><td style="width: 20%;"></td><td style="width: 20%;"></td><td style="width: 20%;"></td><td style="width: 20%;"></td></tr> <tr><td></td><td></td><td></td><td></td><td></td></tr> </table>											<table border="1" style="width: 100%; border-collapse: collapse;"> <tr><td style="width: 20%;"></td><td style="width: 20%;"></td><td style="width: 20%;"></td><td style="width: 20%;"></td><td style="width: 20%;"></td></tr> <tr><td></td><td></td><td></td><td></td><td></td></tr> </table>										











GRUPO 3 PARAFUSOS PARA A INDÚSTRIA DA MADEIRA



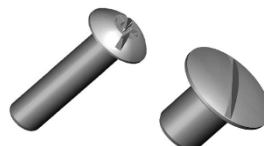

ÍNDICE 3.1

PARAF. ^{OS} CAB. CHATA PZD P/ AGLOMERADO DE MADEIRA	PARAF. ^{OS} CAB. CHATA TORX P/ AGLOMERADO DE MADEIRA	PARAF. ^{OS} CAB. QUEIJO PZD P/ AGLOMERADO DE MADEIRA	PARAF. ^{OS} CAB. CHATA PZD P/ AGLOM., C/ FURO
  PARA O INOX	  PARA O INOX	  PARA O INOX	 
ZN BR. ZN AMR. LATON. OXID.	AÇO A2	AÇO A2	AÇO
AÇO T3.1 T3.1 T3.1 T3.1	ZN BRAN. T3.1 A ZN AMR T3.1 A T3.1 A	ZN BRAN. T3.2 ZN AMR T3.2 T3.2	ZN BRAN. T3.2
A2 T3.1			

PARAFUSOS P/ PUXADORES M-4	PARAF. ^{OS} PARA MADEIRA TURBOSHARP - POZIDRIV	PARAF. ^{OS} PARA MADEIRA TURBOSHARP - TORX	PARAF. ^{OS} PARA MADEIRA LOGLOK - TORX
	 DE ALTO RENDIMENTO P/ MADEIRAS DURAS	 DE ALTO RENDIMENTO P/ MADEIRAS DURAS	 DE ALTO RENDIMENTO P/ MADEIRAS DURAS
4,8	AÇO	AÇO	AÇO
ZN BRAN. T3.2	ZN BR. T 3.2 A ZN AMR T 3.2 A	ZN BR. T 3.2 A0A ZN AMR T 3.2 A0A	ZN AMR T 3.2 AA

PARAF. ^{OS} AUTO-PERFORANTES PARA MADEIRAS DURAS TORX	HASTES ROSCADAS 2 ROSCAS R. MADEIRA + R MÉTRICA	HASTES ROSCADAS 2 ROSCAS 2 ROSCAS MADEIRA	HASTES ROSCADAS 2 ROSCAS R.MADEIRA+R.MÉTRICA
			 SEXTAVADO AO MEIO + TORX
AÇO	4,8	4,8	4,8 A2
ZN AMR T 3.2 B	ZN AMR T3.3	ZN BR. T3.3	ZN BR. T3.3 T3.3

PARAFUSO DE MONTAGEM COM SEXTAVADO INTERIOR	PORCA DE BÚSSOLA (SEM FIM)	CABEÇAS PARA HASTES -FENDADAS-	CABEÇAS PARA HASTES -COM SEXTAVADO INTERIOR-
			
4,8	4,8	4,8 LAT.	4,8
ZN BRAN. T3.3	ZN AMR T3.3	LATON. T3.3 NIQUEL. T3.3 OXIDADO T3.3	LATON. T3.3 NIQUEL. T3.3 OXIDADO T3.3

PARAFUSOS DE LIGAÇÃO COM SEXTAVADO INTERIOR	ESCÁPULA COM RANHURA	CAVILHAS PARA SOALHOS	PITÕES ROSCA MÉTRICA
			
4,8	4,8	200 HV	LAT 4,8
NIQUEL. T3.4	ZN BRAN. T3.4	ZINCADO T3.4	POLIDO ZINCADO T3.5



GRUPO 4 PORCAS E ANILHAS

ÍNDICE 4.1

PORCAS SEXTAVADAS DIN 934	PORCAS SEXTAVADAS DIN 934	PORCAS DE MAMA DIN 1587	PORCAS AUTOBLOCANTES DIN 985																																																													
<p style="writing-mode: vertical-rl; transform: rotate(180deg);">Grupo: 4</p>	<p style="writing-mode: vertical-rl; transform: rotate(180deg);">Grupo: 4</p>	<p style="writing-mode: vertical-rl; transform: rotate(180deg);">Grupo: 4</p>	<p style="writing-mode: vertical-rl; transform: rotate(180deg);">Grupo: 4</p>																																																													
<table border="1" style="width: 100%; border-collapse: collapse;"> <tr> <td></td> <td>CL8</td> <td>CL10</td> <td>A2</td> <td>A4</td> <td></td> </tr> <tr> <td>PRETO</td> <td>T4.1</td> <td>T4.1</td> <td></td> <td></td> <td></td> </tr> <tr> <td>ZN BRAN.</td> <td>T4.1</td> <td>T4.1</td> <td>T4.1</td> <td>T4.1</td> <td></td> </tr> <tr> <td>GALV. Q.</td> <td>T4.1</td> <td></td> <td></td> <td></td> <td></td> </tr> </table>		CL8	CL10	A2	A4		PRETO	T4.1	T4.1				ZN BRAN.	T4.1	T4.1	T4.1	T4.1		GALV. Q.	T4.1					<table border="1" style="width: 100%; border-collapse: collapse;"> <tr> <td></td> <td>CL8 CERTIFICADA</td> <td></td> <td></td> </tr> <tr> <td>PRETO</td> <td>T4.1</td> <td></td> <td></td> </tr> <tr> <td>ZINCADO</td> <td>T4.1</td> <td></td> <td></td> </tr> </table>		CL8 CERTIFICADA			PRETO	T4.1			ZINCADO	T4.1			<table border="1" style="width: 100%; border-collapse: collapse;"> <tr> <td></td> <td>A2</td> <td>A4</td> <td></td> <td></td> </tr> <tr> <td></td> <td>T4.1</td> <td>T4.1</td> <td></td> <td></td> </tr> </table>		A2	A4				T4.1	T4.1			<table border="1" style="width: 100%; border-collapse: collapse;"> <tr> <td></td> <td>CL8</td> <td>A2</td> <td>A4</td> <td></td> </tr> <tr> <td>ZINCADO</td> <td>T4.2</td> <td></td> <td></td> <td></td> </tr> <tr> <td></td> <td></td> <td>T4.2</td> <td>T4.2</td> <td></td> </tr> </table>		CL8	A2	A4		ZINCADO	T4.2						T4.2	T4.2	
	CL8	CL10	A2	A4																																																												
PRETO	T4.1	T4.1																																																														
ZN BRAN.	T4.1	T4.1	T4.1	T4.1																																																												
GALV. Q.	T4.1																																																															
	CL8 CERTIFICADA																																																															
PRETO	T4.1																																																															
ZINCADO	T4.1																																																															
	A2	A4																																																														
	T4.1	T4.1																																																														
	CL8	A2	A4																																																													
ZINCADO	T4.2																																																															
		T4.2	T4.2																																																													
PORCAS AUTOBLOCANTES DIN 980 V	PORCAS COM FLANGE DIN 6923	PORCAS BAIXAS DIN 936	PORCAS DE SOLDAR SEXT. DIN 929																																																													
<p style="writing-mode: vertical-rl; transform: rotate(180deg);">Grupo: 4</p>	<p style="writing-mode: vertical-rl; transform: rotate(180deg);">Grupo: 4</p>	<p style="writing-mode: vertical-rl; transform: rotate(180deg);">Grupo: 4</p>	<p style="writing-mode: vertical-rl; transform: rotate(180deg);">Grupo: 4</p>																																																													
<table border="1" style="width: 100%; border-collapse: collapse;"> <tr> <td></td> <td>CL8</td> <td></td> <td></td> <td></td> </tr> <tr> <td>ZINCADO</td> <td>T4.2</td> <td></td> <td></td> <td></td> </tr> </table>		CL8				ZINCADO	T4.2				<table border="1" style="width: 100%; border-collapse: collapse;"> <tr> <td></td> <td>CL8</td> <td>A2</td> <td></td> </tr> <tr> <td>ZINCADO</td> <td>T4.2</td> <td>T4.2</td> <td></td> </tr> </table>		CL8	A2		ZINCADO	T4.2	T4.2		<table border="1" style="width: 100%; border-collapse: collapse;"> <tr> <td></td> <td>CL8</td> <td></td> <td></td> </tr> <tr> <td>ZINCADO</td> <td>T4.2</td> <td></td> <td></td> </tr> </table>		CL8			ZINCADO	T4.2			<table border="1" style="width: 100%; border-collapse: collapse;"> <tr> <td></td> <td>CL8</td> <td></td> <td></td> </tr> <tr> <td>PRETO</td> <td>T4.2</td> <td></td> <td></td> </tr> </table>		CL8			PRETO	T4.2																													
	CL8																																																															
ZINCADO	T4.2																																																															
	CL8	A2																																																														
ZINCADO	T4.2	T4.2																																																														
	CL8																																																															
ZINCADO	T4.2																																																															
	CL8																																																															
PRETO	T4.2																																																															
PORCAS DE SOLDAR QUAD. DIN 928	PORCAS DE ORELHAS MOD. AMERICANO - MET. e BSW	PORCAS DE GARRA	UNIÕES SEXTAVADAS																																																													
<p style="writing-mode: vertical-rl; transform: rotate(180deg);">Grupo: 4</p>	<p style="writing-mode: vertical-rl; transform: rotate(180deg);">Grupo: 4</p>	<p style="writing-mode: vertical-rl; transform: rotate(180deg);">Grupo: 4</p>	<p style="writing-mode: vertical-rl; transform: rotate(180deg);">Grupo: 4</p>																																																													
<table border="1" style="width: 100%; border-collapse: collapse;"> <tr> <td></td> <td>CL8</td> <td></td> <td></td> </tr> <tr> <td>PRETO</td> <td>T4.2</td> <td></td> <td></td> </tr> </table>		CL8			PRETO	T4.2			<table border="1" style="width: 100%; border-collapse: collapse;"> <tr> <td></td> <td colspan="2">METRICA</td> <td>BSW</td> </tr> <tr> <td></td> <td>CL6</td> <td>A2</td> <td>CL6</td> </tr> <tr> <td>PRETO</td> <td>T4.2</td> <td>T4.2</td> <td>T4.2</td> </tr> <tr> <td>ZINCADO</td> <td>T4.2</td> <td>T4.2</td> <td>T4.2</td> </tr> </table>		METRICA		BSW		CL6	A2	CL6	PRETO	T4.2	T4.2	T4.2	ZINCADO	T4.2	T4.2	T4.2	<table border="1" style="width: 100%; border-collapse: collapse;"> <tr> <td></td> <td>CL6</td> <td></td> </tr> <tr> <td>ZN AMR</td> <td>T4.2</td> <td></td> </tr> </table>		CL6		ZN AMR	T4.2		<table border="1" style="width: 100%; border-collapse: collapse;"> <tr> <td></td> <td>CL6</td> <td>A2</td> </tr> <tr> <td>ZINCADO</td> <td>T4.2</td> <td>T4.2</td> </tr> </table>		CL6	A2	ZINCADO	T4.2	T4.2																									
	CL8																																																															
PRETO	T4.2																																																															
	METRICA		BSW																																																													
	CL6	A2	CL6																																																													
PRETO	T4.2	T4.2	T4.2																																																													
ZINCADO	T4.2	T4.2	T4.2																																																													
	CL6																																																															
ZN AMR	T4.2																																																															
	CL6	A2																																																														
ZINCADO	T4.2	T4.2																																																														
PORCAS DE CANDEEIRO M10 x 1	ANILHAS PLANAS DIN 125-A	ANILHAS DE ABA LARGA DIN 9021	ANILHAS DE MOLA DIN 127-B																																																													
<p style="writing-mode: vertical-rl; transform: rotate(180deg);">Grupo: 4</p>	<p style="writing-mode: vertical-rl; transform: rotate(180deg);">Grupo: 4</p>	<p style="writing-mode: vertical-rl; transform: rotate(180deg);">Grupo: 4</p>	<p style="writing-mode: vertical-rl; transform: rotate(180deg);">Grupo: 4</p>																																																													
<table border="1" style="width: 100%; border-collapse: collapse;"> <tr> <td></td> <td>CL6</td> <td></td> <td></td> </tr> <tr> <td>ZN AMR</td> <td>T4.2</td> <td></td> <td></td> </tr> </table>		CL6			ZN AMR	T4.2			<table border="1" style="width: 100%; border-collapse: collapse;"> <tr> <td></td> <td>200 HV</td> <td>A2</td> <td>A4</td> </tr> <tr> <td>ZINCADO</td> <td>T4.3</td> <td></td> <td></td> </tr> <tr> <td>GALVAN.</td> <td>T4.3</td> <td>T4.3</td> <td>T4.3</td> </tr> </table>		200 HV	A2	A4	ZINCADO	T4.3			GALVAN.	T4.3	T4.3	T4.3	<table border="1" style="width: 100%; border-collapse: collapse;"> <tr> <td></td> <td>200 HV</td> <td>A2</td> <td>A4</td> </tr> <tr> <td>ZINCADO</td> <td>T4.3</td> <td></td> <td></td> </tr> <tr> <td>GALVAN.</td> <td>T4.3</td> <td>T4.3</td> <td>T4.3</td> </tr> </table>		200 HV	A2	A4	ZINCADO	T4.3			GALVAN.	T4.3	T4.3	T4.3	<table border="1" style="width: 100%; border-collapse: collapse;"> <tr> <td></td> <td>200 HB30</td> <td>A2</td> <td>A4</td> </tr> <tr> <td>PRETO</td> <td>T4.3</td> <td></td> <td></td> </tr> <tr> <td>ZINCADO</td> <td>T4.3</td> <td>T4.3</td> <td>T4.3</td> </tr> </table>		200 HB30	A2	A4	PRETO	T4.3			ZINCADO	T4.3	T4.3	T4.3																	
	CL6																																																															
ZN AMR	T4.2																																																															
	200 HV	A2	A4																																																													
ZINCADO	T4.3																																																															
GALVAN.	T4.3	T4.3	T4.3																																																													
	200 HV	A2	A4																																																													
ZINCADO	T4.3																																																															
GALVAN.	T4.3	T4.3	T4.3																																																													
	200 HB30	A2	A4																																																													
PRETO	T4.3																																																															
ZINCADO	T4.3	T4.3	T4.3																																																													
ANILHAS RECARILHADAS DIN 6798-A	ANILHAS VULCANIZADAS EPDM	ANILHAS CÔNCAVAS Ø 30 mm	ANILHAS CÔNCAVAS BORRACHA																																																													
<p style="writing-mode: vertical-rl; transform: rotate(180deg);">Grupo: 4</p>	<p style="writing-mode: vertical-rl; transform: rotate(180deg);">Grupo: 4</p>	<p style="writing-mode: vertical-rl; transform: rotate(180deg);">Grupo: 4</p>	<p style="writing-mode: vertical-rl; transform: rotate(180deg);">Grupo: 4</p>																																																													
<table border="1" style="width: 100%; border-collapse: collapse;"> <tr> <td></td> <td>350-425 HV10</td> <td>A2</td> </tr> <tr> <td>PRETO</td> <td>T4.3</td> <td></td> </tr> <tr> <td>ZINCADO</td> <td>T4.3</td> <td>T4.3</td> </tr> </table>		350-425 HV10	A2	PRETO	T4.3		ZINCADO	T4.3	T4.3	<table border="1" style="width: 100%; border-collapse: collapse;"> <tr> <td></td> <td>100 HV</td> <td>A2</td> </tr> <tr> <td>ZINCADO</td> <td>T4.3</td> <td>T4.3</td> </tr> </table>		100 HV	A2	ZINCADO	T4.3	T4.3	<table border="1" style="width: 100%; border-collapse: collapse;"> <tr> <td></td> <td>100 HV</td> <td>A2</td> </tr> <tr> <td>ZINCADO</td> <td>T4.3</td> <td>T4.3</td> </tr> </table>		100 HV	A2	ZINCADO	T4.3	T4.3	<table border="1" style="width: 100%; border-collapse: collapse;"> <tr> <td></td> <td colspan="2">BORRACHA</td> </tr> <tr> <td></td> <td colspan="2">T4.3</td> </tr> </table>		BORRACHA			T4.3																																			
	350-425 HV10	A2																																																														
PRETO	T4.3																																																															
ZINCADO	T4.3	T4.3																																																														
	100 HV	A2																																																														
ZINCADO	T4.3	T4.3																																																														
	100 HV	A2																																																														
ZINCADO	T4.3	T4.3																																																														
	BORRACHA																																																															
	T4.3																																																															



GRUPO 4 PORCAS E ANILHAS

ÍNDICE 4.2

ANILHAS CÔNCAVAS Ø 19 mm		ANILHAS DE BORRACHA Ø 19 mm			
Grupo: 4		Grupo: 4			
	100 HV ZINCADO T4.3		BORRACHA T4.3		



GRUPO 5 FREIOS, GOLPILHAS E CAVILHAS

ÍNDICE 5.1

FREIOS SEGUR. EXTERIORES DIN 471	FREIOS SEGUR. INTERIORES DIN 472	FREIOS DE CAVALEIRO DIN 6799	GOLPILHAS 1/2 CANA DIN 94
<p style="writing-mode: vertical-rl; transform: rotate(180deg);">Grupo: 5</p>	<p style="writing-mode: vertical-rl; transform: rotate(180deg);">Grupo: 5</p>	<p style="writing-mode: vertical-rl; transform: rotate(180deg);">Grupo: 5</p>	<p style="writing-mode: vertical-rl; transform: rotate(180deg);">Grupo: 5</p>
435-580 HV	435-580 HV	435-580 HV	100 HV A2
FOSFAT. T 5.1	FOSFAT. T 5.1	FOSFAT. T 5.1	ZINCADO T 5.2 T 5.2

GOLPILHAS BETA	CHAVETAS DE ARGOLA DIN 11023	CAVILHAS ELASTICAS DIN 1481 - ISO 8752	
<p style="writing-mode: vertical-rl; transform: rotate(180deg);">Grupo: 5</p>	<p style="writing-mode: vertical-rl; transform: rotate(180deg);">Grupo: 5</p>	<p style="writing-mode: vertical-rl; transform: rotate(180deg);">Grupo: 5</p>	
200 HV	100 HV	420-520 HV A2	
ZINCADO T 5.2	ZINCADO T 5.2	PRETO T 5.3 T5.3	



GRUPO 6 REBITES

ÍNDICE 6.1

REBITES DIN 7337		REBITES DE ABA LARGA		REBITES ESTANQUES		REBITES FLOR	
Grupo: 6		Grupo: 6		Grupo: 6		Grupo: 6	
	ALU T6.1	ALU T6.2		ALU T6.2		ALU T6.2	
NATURAL	T6.1						
LACADO	T6.1						
ZINCADO	T6.1						

PORCAS DE REBITAR ESTRIADAS		PORCAS DE REBITAR ESTRIADAS - CAB. REDUZIDA		PORCAS DE REBITAR ESTRIADAS - CAB. EMBEBER		ALICATE DE REBITAR AÇO ESTAMPADO	
Grupo: 6		Grupo: 6		Grupo: 6		Grupo: 6	
	4,8 A2	4,8 A2		4,8			
ZINCADO	T6.3	ZINCADO	T6.3	ZINCADO	T6.3		HR-702
	T6.3		T6.3				T 6.4

ALICATE DE REBITAR LIGA DE ALUMÍNIO		ALICATE DE REBITAR DE LAGARTAS		ALICATE DE REBITAR DE BRAÇOS		ALICATE PARA PORCAS DE REBITAR	
Grupo: 6		Grupo: 6		Grupo: 6		Grupo: 6	
	HR-705		HR-710		HR-730		HN-02
	T 6.4		T 6.4		T 6.4		T 6.4 A

PISTOLA PNEUMÁTICA PARA PORCAS DE REBITAR		PISTOLA PNEUMÁTICA PARA PORCAS DE REBITAR		PISTOLA DE REBITAR PNEUMÁTICA		PISTOLA DE REBITAR PNEUMÁTICA	
Grupo: 6		Grupo: 6		Grupo: 6		Grupo: 6	
	SN-6		SN-10		SRC-55P		SRC-56P
	T 6.4 A		T 6.4 A		T 6.5		T 6.5

PISTOLA DE REBITAR PNEUMÁTICA		PISTOLA DE REBITAR PNEUMÁTICA					
Grupo: 6		Grupo: 6					
	Sistema de vácuo		Sistema de vácuo				
	SRC-A5		SRC-A6				
	T 6.5		T 6.5				



GRUPO 7 BUCHAS / FIXAÇÃO

ÍNDICE 7.1

BUCHAS "CH" COM PARAFUSO		BUCHAS "CH" COM GANCHO		BUCHAS "CH" COM OLHAL		BUCHAS "CH" COM PARAFUSO DIN 7991 A2		
Grupo: 7								
	ZINCADO	AÇO T7.1	A2 T7.1	A4 T7.1	ZINCADO	AÇO T7.1	A2 T7.1	ZINCADO

BUCHA DE CUNHA "MTA"		BUCHA DE CUNHA "MTA" CERTIFICADA - ETA OPÇÃO 1		BUCHAS DE AÇO - "FB"		BUCHAS "FB" C/ PARAFUSO					
Grupo: 7											
	ZINCADO	AÇO T7.2	A2 T7.2	A4 T7.2	ZINCADO	AÇO T7.3	A2 T7.3	A4 T7.3	ZINCADO	AÇO T7.3	A2 T7.3

BUCHAS "FB" C/ GANCHO		BUCHAS "FB" C/ OLHAL		BUCHAS "FB" C/ ESCÁPULA		BUCHAS ZAMAK HPM		
Grupo: 7								
	ZINCADO	AÇO T7.3	A2 T7.3	ZINCADO	AÇO T7.3	A2 T7.3	ZINCADO	ZAMAK T7.4





BUCHAS ZAMAK HPM COM PARAFUSO		BUCHAS ZAMAK HPM COM GANCHO		BUCHAS ZAMAK HPM COM OLHAL		BUCHA "JUNIOR" AÇO ZINCADO		
Grupo: 7								
	ZINCADO	ZAMAK T7.4	ZINCADO	ZAMAK T7.4	ZINCADO	ZAMAK T7.4	ZINCADO	AÇO T7.5



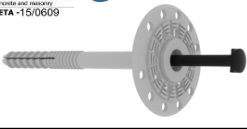

BUCHA "JUNIOR" INOX A2		BUCHA "JUNIOR" INOX A4		BUCHAS DE LATÃO		BUCHAS "PFG"		
Grupo: 7								
	ZINCADO	A2 T7.5	ZINCADO	A4 T7.5	ZINCADO	LAT. T7.5	ZINCADO	AÇO GALV. DIF. T7.6



GRUPO 7 BUCHAS / FIXAÇÃO



ÍNDICE 7.3

BUCHAS PARA CAPOTO	BUCHAS METÁLICAS PARA CAIXILHARIA	BUCHAS EM NYLON P/ PLACAS GESSO CARTONADO	BUCHAS AUTO-PERFORANTES P/ GESSO CARTONADO
<p>Grupo: 7</p> 	<p>Grupo: 7</p> 	<p>Grupo: 7</p> 	<p>Grupo: 7</p> 
COPOLÍMERO / NYLON	AÇO	NYLON	ZAMAK / NYLON
T 7.10 F	PARAF. AÇO ZINCADO T 7.11	T 7.12	T 7.12

BUCHAS DE MOLA	BUCHAS DE BASCULAR	BUCHAS GUARDA-CHUVA	OLHAL PARA BUCHAS GUARDA-CHUVA
<p>Grupo: 7</p> 	<p>Grupo: 7</p> 	<p>Grupo: 7</p> 	<p>Grupo: 7</p> 
AÇO	AÇO	AÇO	AÇO
ZINCADO T7.12	ZINCADO T7.12	ZINCADO T7.13	ZINCADO T7.13

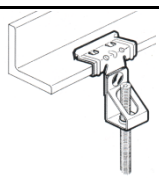
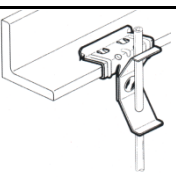
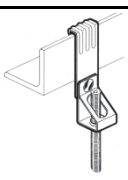
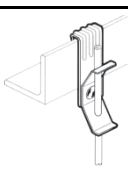
CAMARÃO PARA BUCHAS GUARDA-CHUVA	ALICATE PARA EXPANDIR BUCHAS GUARDA-CHUVA	GANCHO ESTAMPADO A FRIO	OLHAL ESTAMPADO A FRIO
<p>Grupo: 7</p> 	<p>Grupo: 7</p> 	<p>Grupo: 7</p> 	<p>Grupo: 7</p> 
AÇO	METAL	AÇO A2	AÇO A2
ZINCADO T7.13	T7.13	ZINCADO T7.14 T7.14	ZINCADO T7.14 T7.14



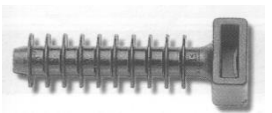















DISPOSITIVO DE FIXAÇÃO RÁPIDA PARA TECTOS FALSOS PERFIL HORIZONTAL - DE ROSCAR	DISPOSITIVO DE FIXAÇÃO RÁPIDA PARA TECTOS FALSOS PERFIL HORIZONTAL - DE MOLA	DISPOSITIVO DE FIXAÇÃO RÁPIDA PARA TECTOS FALSOS PERFIL VERTICAL - DE ROSCAR	DISPOSITIVO DE FIXAÇÃO RÁPIDA PARA TECTOS FALSOS PERFIL VERTICAL - DE MOLA
<p>Grupo: 7</p> 	<p>Grupo: 7</p> 	<p>Grupo: 7</p> 	<p>Grupo: 7</p> 
AÇO	AÇO	AÇO	AÇO
FOSFAT. T7.15	FOSFAT. T7.15	FOSFAT. T7.15	FOSFAT. T7.15

ABRAÇADEIRAS DE FIVELA	ABRAÇADEIRAS DE FIVELA	ABRAÇADEIRAS "CINTO"	BUCHA PARA FIXAR ABRAÇADEIRAS
<p>Grupo: 7</p> 	<p>Grupo: 7</p> 	<p>Grupo: 7</p> 	<p>Grupo: 7</p> 
POLIAMIDA 6.6	POLIAMIDA 6.6	POLIAMIDA 12	NYLON
PRETO BRAN. VERM. VERD. AMAR. AZUL T 7.16	PRETO BRAN. VERM. VERD. AMAR. AZUL T 7.016	T 7.17	T 7.17



GRUPO 7 BUCHAS / FIXAÇÃO



ÍNDICE 7.4

ESTICADORES P/ ABRAÇADEIRAS		ESTICADORES P/ ABRAÇADEIRAS		CLIPS POLIETILENO PARA CABOS REDONDOS E PLANOS		BUCHAS PARA CAPOTO LTX-10	
Grupo: 7	 ELEMATIC®	Grupo: 7	 ELEMATIC®	Grupo: 7	 PARAFAST	Grupo: 7	 KLIMAS FASTENER TECHNOLOGIES ETA CE ETA-16/0509
P/ ABRAÇADEIRAS "CINTO"		P/ ABRAÇADEIRAS "DE FIVELA"		PE		POLIETILENO (+ ACESSÓRIOS)	
T 7.17		T 7.17		T 7.18		T 7.25	
BUCHAS PARA LÂ DE ROCHA LMX-10		BUCHAS ROSCAR NO CAPOTO WK-DS		ANILHAS NIVELADORAS DW		BUCHAS PARA CAIXILHARIA KPS-FAST / KPR-FAST	
Grupo: 7	 KLIMAS FASTENER TECHNOLOGIES ETA CE ETA-16/0509	Grupo: 7	 KLIMAS FASTENER TECHNOLOGIES	Grupo: 7	 KLIMAS FASTENER TECHNOLOGIES	Grupo: 7	 KLIMAS FASTENER TECHNOLOGIES ETA CE ETA-12/0272
POLIETILENO (+ ACESSÓRIOS)		50 mm; 85 mm		40x40 mm; 2 a 15 mm		NYLON AÇO ZINCADO - FLOCOS ZN	
T 7.26		T 7.27		T 7.27		T 7.28	
BUCHAS PARA CAIXILHARIA KPS-FAST-A4 / KPR-FAST-A4		BUCHAS LONGAS EM NYLON KPR		BUCHAS PARA ANDAIMES HOX		PARAF.ºS ROSCAR NO BETÃO WHO / WHOW	
Grupo: 7	 KLIMAS FASTENER TECHNOLOGIES ETA CE ETA-12/0272	Grupo: 7	 KLIMAS FASTENER TECHNOLOGIES	Grupo: 7	 KLIMAS FASTENER TECHNOLOGIES	Grupo: 7	 KLIMAS FASTENER TECHNOLOGIES Para caixilharia
NYLON AÇO INOX A4		NYLON		NYLON OLHAL: AÇO ZINCADO		AÇO ZINCADO	
T 7.29		T 7.30		T 7.30		T 7.31	
TAPITS CABEÇA CÔNICA SM		BUCHAS DE CUNHA "MTA" LE-ZNA4 / LE-A4		PARAFUSOS PARA DECK HNT		PARAFUSOS BROCA LACADOS WF	
Grupo: 7	 KLIMAS FASTENER TECHNOLOGIES ETA CE ETA-19/0156	Grupo: 7	 KLIMAS FASTENER TECHNOLOGIES ETA CE ETA-20/0641	Grupo: 7	 KLIMAS FASTENER TECHNOLOGIES	Grupo: 7	 KLIMAS FASTENER TECHNOLOGIES ETA CE ETA-16/0443
POLIETILENO AÇO ZINCADO		AÇO ZINCADO AÇO INOX-A4		TORX AÇO INOX-A2		AÇO ZINCADO / LACADO CORES RAL - ANILHA EPDM	
T 7.32		T 7.33		T 7.33		T 7.34	
PARAF.ºS ROSCAR NO BETÃO WDBLS / WDBLP		PARAFUSOS P. SANDWICH WB6P					
Grupo: 7	 KLIMAS FASTENER TECHNOLOGIES ETA CE ETA-20/0768 ETA-20/0769	Grupo: 7	 KLIMAS FASTENER TECHNOLOGIES ETA CE ETA-16/0444				
AÇO ZINCADO		Revestimento SQ CERAMIC ROSCAR NO BETÃO - C/ EPDM					
T 7.35		T 7.36					











GRUPO 8 QUÍMICOS (SILICONES, RESINAS E SPRAYS)

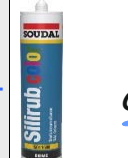



ÍNDICE 8.1

BUCHAS QUÍMICAS WORLDFIX 400, 500		ACESSÓRIOS PARA BUCHA QUÍMICA			PERNOS P/ BUCHAS QUÍMICAS		ESPUMA DE POLIURETANO			
Grupo: 8										
	400 POLIESTER		500 VINILESTER EPOXIACRILATO		PISTOLAS	BOQUILHA	CAMISA	MANUAL	PARA PISTOLA	
	T 8.01		T 8.01 A		T 8.1	T 8.1	T 8.1			T 8.2
						ZINCADO	5,8	8,8	A2	A4
							T8.1	T8.1	T8.1	T8.1

ESPUMA PARA TELHAS		ESPUMA PU CORTA-FOGO Soudafoam FR		ESPUMA PARA CAPOTO "Soudabond Easy"		ACESSÓRIOS PARA ESPUMA DE POLIURETANO		
Grupo: 8								
	MANUAL	PARA PISTOLA	MANUAL	PARA PISTOLA	PARA PISTOLA UNIVERSAL		PRODUTO DE LIMPEZA	PISTOLAS PARA POLIURETANO
	T 8.2	T 8.2	T 8.2 0A	T 8.2 0A	T 8.2 A		T 8.2 A	T 8.2 A

SILICONE ACÉTICO "SILIRUB AS" - "UNIVERSAL"		SILICONE NEUTRO "SILIRUB N" - "SILIRUB NS"		SILICONE NEUTRO "SILIRUB COLOR"		COLA E VEDA "Soudaflex 40 FC"		
Grupo: 8								
	TODAS AS CORES (COM / SEM FUNGICIDA)		TODAS AS CORES (SEM / COM FUNGICIDA)		TODAS AS CORES (COM BIOCIDA FUNGICIDA)		BRANCO, CINZA, PRETO TERRACOTA , CASTANHO	
	T 8.3		T 8.3 A		T 8.3 A		T 8.4	

PREGO LÍQUIDO "MONTAGEPRO 140"		COLA DE MONTAGEM "PREGO LÍQUIDO" - "48 A"		PREGO LÍQUIDO TRANSPARENTE "PUROCOL"		COLA DE MONTAGEM PREGO LÍQUIDO - "FIXA +"		
Grupo: 8								
	BRANCO		BEGE		TRANSPARENTE		"PROFISSIONAL" - BEGE BASE SOLVENTE	
	T 8.4 A		T 8.4 A		T 8.4 A		T 8.4 A1	

COLA DE MONTAGEM PREGO LÍQUIDO - "FIXA +"		COLA E VEDA "MULTIBOND MS35"		SILICONE ALTAS TEMPERATURAS "HT-N"		SILICONE ALTAS TEMPERATURAS "GASKET SEAL"		
Grupo: 8								
	"MATERIAIS PESADOS" - BRANCO BASE AQUOSA		BRANCO, CINZA, PRETO TERRACOTA		PRETO		ROXO	
	T 8.4 A1		T 8.4 B		T 8.5		T 8.5	



GRUPO 8 QUÍMICOS (SILICONES, RESINAS E SPRAYS)

ÍNDICE 8.2

MASSA REFRACTÁRIA "CALOFER"		SELANTE ACRÍLICO "ACRYL FLEX"		TAPA GRETAS "ACRYRUB N"		"TAPA-GRETAS" AREADO REPA-CRYL D		
Grupo: 8	 SODAL Resiste até 1500 °C		Grupo: 8	 SODAL Flexível		Grupo: 8	 SODAL Pintável	
	CINZA ANTRACITE			BRANCO			BRANCO, CINZA	
T 8.5		T 8.5 A		T 8.6		T 8.6		
SELAGEM E ENCHIMENTO REPAIR EXPRESS		T-REX POWER		T-REX CRISTAL		T-REX TURBO		
Grupo: 8	 SODAL Pintável		Grupo: 8	 SODAL T-REX POWER		Grupo: 8	 SODAL T-REX CRISTAL	
	BRANCO			BRANCO, CINZA, PRETO BEGE, TERRACOTA			TRANSPARENTE	
T 8.6		T 8.7		T 8.7		T 8.7		
T-REX X-TREME		T-REX FLEX		T-REX FLOOR & WALL		T-REX CLEANER		
Grupo: 8	 SODAL T-REX X-TREME		Grupo: 8	 SODAL T-REX FLEX		Grupo: 8	 SODAL T-REX FLOOR & WALL ADHESIVE	
	BRANCO			BRANCO			400 ml	
T 8.7		T 8.7		T 8.8		T 8.8		
COLA DE CONTACTO 44A - 46A - SPRAY		SILICONE LÍQUIDO HYDROBLOCK WET		PELE ELÁSTICA HYDROBLOCK DRY		HIDRRORREPELENTE HYDROBLOCK CLEAR		
Grupo: 8	 SODAL - Carpintaria - Montagem - Indústria		Grupo: 8	TECNOLOGIA SMX SODAL 		Grupo: 8	 SODAL	
	LÍQUIDA 44A	GEL 46A		SPRAY	TELHA, CINZA BRANCO, PRETO		TELHA, CINZA BRANCO	
T 8.10	T 8.10	T 8.10	T 8.11		T 8.11 A		T 8.11 B	
FITA ADESIVA DE BUTILO HYDROBLOCK BAND		TRATAMENTO ANTI-FUNGOS HYDROBLOCK CLEAN		SPRAY LUBRIFICANTE MULTIFUNCIONAL - "OIL"		PISTOLAS PARA SILICONE		
Grupo: 8	 SODAL		Grupo: 8	 SODAL		Grupo: 8	 SODAL	
	ALUMÍNIO			TRANSLÚCIDO			200 ml - 500 ml	
T 8.11 B		T 8.11 B		T 8.12		SEMIPROFISSIONAL, PROFISSIONAL		
T 8.11 B		T 8.11 B		T 8.12		T 8.13		



GRUPO 8 QUÍMICOS (SILICONES, RESINAS E SPRAYS)



ÍNDICE 8.3

<p>PISTOLAS PARA ESPUMA DE POLIURETANO</p> <p>Grupo: 8</p>  <p>PROFISSIONAL</p> <p>T 8.13 A</p>	<p>PISTOLAS PARA RESINA</p> <p>Grupo: 8</p>  <p>PROFISSIONAL ULTRA-LEVE</p> <p>T 8.13 A</p>	<p>LOCTITE "SUPER COLA 3" "ORIGINAL (N.º 1)"</p> <p>Grupo: 8</p>  <p>TRANSPARENTE</p> <p>T 8.14</p>	<p>LOCTITE "SUPER COLA 3" "PRECISÃO"</p> <p>Grupo: 8</p>  <p>TRANSPARENTE</p> <p>T 8.14</p>
<p>LOCTITE "SUPER COLA 3" "PINCEL"</p> <p>Grupo: 8</p>  <p>TRANSPARENTE</p> <p>T 8.14</p>	<p>LOCTITE "SUPER COLA 3" "PROFISSIONAL"</p> <p>Grupo: 8</p>  <p>TRANSPARENTE</p> <p>T 8.14</p>	<p>LOCTITE "SUPER COLA 3" "VIDRO"</p> <p>Grupo: 8</p>  <p>TRANSPARENTE</p> <p>T 8.14</p>	<p>LOCTITE "SUPER COLA 3" "CONTROL"</p> <p>Grupo: 8</p>  <p>TRANSPARENTE</p> <p>T 8.14</p>
<p>LOCTITE "SUPER COLA 3" "PURE GEL"</p> <p>Grupo: 8</p>  <p>TRANSPARENTE</p> <p>T 8.14 A</p>	<p>LOCTITE "SUPER COLA 3" "POWER FLEX GEL"</p> <p>Grupo: 8</p>  <p>TRANSPARENTE</p> <p>T 8.14 A</p>	<p>Cola especial para PVC rígido "COLA ESPECIAL PVC"</p> <p>Grupo: 8</p>  <p>BISNAGA 125 g LATA 250 g</p> <p>T 8.15</p>	<p>Produto limpeza p/ PVC rígido "PRODUTO DE LIMPEZA PVC"</p> <p>Grupo: 8</p>  <p>LATA 0,5 L LATA 1 L</p> <p>T 8.15</p>
<p>Vedante de roscas universal (em fio) - "UNI-LOCK"</p> <p>Grupo: 8</p>  <p>DISPENSADOR 80 m DISPENSADOR 160 m</p> <p>T 8.16</p>	<p>Vedante de roscas metálicas "METALOCK"</p> <p>Grupo: 8</p>  <p>FRASCO 50 ml</p> <p>T 8.16</p>	<p>Vedante de roscas plásticas "PLASTICLOCK"</p> <p>Grupo: 8</p>  <p>BISNAGA 100 ml</p> <p>T 8.16</p>	<p>Fita de reparação multiusos "FIX IT"</p> <p>Grupo: 8</p>  <p>ROLO 3 m</p> <p>T 8.17</p>
<p>MASSA REPARADORA</p> <p>Grupo: 8</p>  <p>TUBO 110 g</p> <p>T 8.17</p>	<p>FIXADOR DE ROSCAS METÁLICAS "NURAL 50"</p> <p>Grupo: 8</p>  <p>PRETO</p> <p>T 8.17 A</p>	<p>FIXADOR DE ROSCAS METÁLICAS "NURAL 51"</p> <p>Grupo: 8</p>  <p>PRETO</p> <p>T 8.17 A</p>	<p>FIXADOR DE ROSCAS METÁLICAS "NURAL 53"</p> <p>Grupo: 8</p>  <p>PRETO</p> <p>T 8.17 A</p>



GRUPO 8 QUÍMICOS (SILICONES, RESINAS E SPRAYS)

ÍNDICE 8.4

Produto Multi-Use Original WD-40	Produto Multi-Use Dupla Ação	Produto Multi-Use Flexível	Óleo de Corte Multiusos WD-40 Specialist®
Grupo: 8 	Grupo: 8 	Grupo: 8 	Grupo: 8 
200 ml - 400 ml - 5 litros	PULVERIZADOR DUPLA AÇÃO	PULVERIZADOR DUPLA AÇÃO	PULVERIZADOR DUPLA AÇÃO
T 8.17.A1	T 8.17.A2	T 8.17.A2	T 8.17.A3
Penetrante Ação Rápida WD-40 Specialist®	Desengordurante WD-40 Specialist®	TECH AEROSOL	SPRAY DE TINTA ESMALTE ACRÍLICO MULTIUSOS
Grupo: 8 	Grupo: 8 	Grupo: 8 	Grupo: 8 
PULVERIZADOR DUPLA AÇÃO	PULVERIZADOR DUPLA AÇÃO	SPRAYS DE TINTA - SPRAYS TÉCNICOS PRODUTOS DE LIMPEZA - ACESSÓRIOS	SPRAY 400 ml
T 8.17.A3	T 8.17.A3	T 8.18	T 8.18.0
ACESSÓRIOS SPRAYS TINTA PISTOLA PARA SPRAY	SPRAY DE TINTA MARCADOR NORMAL	SPRAY DE TINTA MARCADOR FLUORESCENTE	SPRAY DE TINTA SPOILERS E PEÇAS PLÁSTICAS
Grupo: 8  Ref.ª 3170	Grupo: 8  64	Grupo: 8  64 FLUO	Grupo: 8  100 PL
PARA SPRAY 400 ml	SPRAY 500 ml	SPRAY 500 ml	SPRAY 400 ml
T 8.18.0A	T 8.18.0A	T 8.18.0A	T 8.18.0A
SPRAY DE TINTA PRIMÁRIO ANTIFERRUGEM	SPRAY DE TINTA PRIMÁRIO MATERIAIS PLÁSTICOS	SPRAY DE TINTA EFEITO CROMADO	SPRAY DE TINTA JANTES DE ALUMÍNIO
Grupo: 8  100 AR	Grupo: 8  100 PR	Grupo: 8  100 CR	Grupo: 8 
SPRAY 400 ml	SPRAY 400 ml	SPRAY 400 ml	SPRAY 400 ml
T 8.18.0B	T 8.18.0B	T 8.18.0C	T 8.18.0C
SPRAY DE TINTA ALTAS TEMPERATURAS	SPRAY DE TINTA EFEITO DE FORJA	SPRAY DE TINTA COBRE MANCHAS	SPRAY DE TINTA DE ENCHIMENTO
Grupo: 8  100 HT	Grupo: 8  100 FE	Grupo: 8 	Grupo: 8 
SPRAY 400 ml	SPRAY 400 ml	SPRAY 500 ml	SPRAY 400 ml
T 8.18.0C	T 8.18.0D	T 8.18.0D	T 8.18.0D



GRUPO 8 QUÍMICOS (SILICONES, RESINAS E SPRAYS)

ÍNDICE 8.5

MARCADORES MARKER-TECH TECH AEROSOL		SPRAY LUBRIFICANTE MULTIFUNCIONAL SVITA T1		SPRAY LUBRIFICANTE DESBLOQUEADOR ANTIFERRUGEM		SPRAY LUBRIFICANTE MULTIFUNCIONAL SVITA MARINE	
Grupo: 8		Grupo: 8		Grupo: 8		Grupo: 8	
	*ROTULADORES *MADEIRA *JUNTAS CERÁMICAS *ELETRODOMÉSTICOS *RADIADORES		Ref.ª 0001		Ref.ª 0340		Ref.ª 1685
SPRAY 400 ml		SPRAY 400 ml		SPRAY 400 ml		SPRAY 400 ml	
T 8.18.0E		T 8.18.0F FACTOTUM		T 8.18.0F 48		T 8.18.0F 73	
SPRAY LUBRIFICANTE DESBLOQUEADOR MoS2		SPRAY LUBRIFICANTE MASSA CONSISTENTE MULTIUSOS		SPRAY LUBRIFICANTE MASSA CONS. NÁUTICA DE LÍCIO		SPRAY LUBRIFICANTE MASSA BISULFURETO DE MOLIBDÊNIO	
Grupo: 8		Grupo: 8		Grupo: 8		Grupo: 8	
	Ref.ª 1605		Ref.ª 0345		Ref.ª 0295		Ref.ª 0310
SPRAY 400 ml		SPRAY 400 ml		SPRAY 400 ml		SPRAY 400 ml	
T 8.18.0F		T 8.18.0F 18		T 8.18.0F		T 8.18.0F 15	
SPRAY LUBRIFICANTE MASSA DE PTFE		SPRAY LUBRIFICANTE MASSA PARA CORRENTES		SPRAY LUBRIFICANTE MASSA CORRENTES PROFISSIONAL		SPRAY LUBRIFICANTE ÓLEO DE SILICONE	
Grupo: 8		Grupo: 8		Grupo: 8		Grupo: 8	
	Ref.ª 0285		Ref.ª 0300		Ref.ª 0245		Ref.ª 0190
SPRAY 400 ml		SPRAY 400 ml		SPRAY 400 ml		SPRAY 400 ml	
T 8.18.0G		T 8.18.0G		T 8.18.0G		T 8.18.0G 21	
SPRAY LUBRIFICANTE ÓLEO DE CORTE		SPRAY LUBRIFICANTE ÓLEO PARA ARMAS		SPRAY DE ZINCO 98%		SPRAY DE ZINCO CLARO	
Grupo: 8		Grupo: 8		Grupo: 8		Grupo: 8	
	Ref.ª 0320		Ref.ª 1465		Ref.ª 0470		Ref.ª 0485
SPRAY 400 ml		SPRAY 400 ml		SPRAY 400 ml		SPRAY 400 ml	
T 8.18.0G 20		T 8.18.0G		T 8.18.0H 50		T 8.18.0H	
SPRAY DE ZINCO BRILHANTE		SPRAY DE INOX CLARO		SPRAY DE INOX ESCURO		SPRAY DE MANUTENÇÃO DESOX. SECO CONTAC. ELETRÔNICOS	
Grupo: 8		Grupo: 8		Grupo: 8		Grupo: 8	
	Ref.ª 0460		Ref.ª 2900		Ref.ª 2905		Ref.ª 3090
SPRAY 400 ml		SPRAY 400 ml		SPRAY 400 ml		SPRAY 400 ml	
T 8.18.0H 49		T 8.18.0H 33		T 8.18.0H		T 8.18.0I 37	



GRUPO 8 QUÍMICOS (SILICONES, RESINAS E SPRAYS)

ÍNDICE 8.6









SPRAY DE MANUTENÇÃO DECAPANTE	SPRAY DE MANUTENÇÃO DETECTOR DE FUGAS DE GÁS	PRODUTO DE MANUTENÇÃO CONVERTIDOR DE ÓXIDO	SPRAY DE MANUTENÇÃO ENCHE E REPARA PNEUS
 Ref.ª 0095	 Ref.ª 0385	 Ref.ª 1900	 Ref.ª 0160
SPRAY 400 ml	SPRAY 400 ml	RECIPIENTE 250 ml e 1 L	SPRAY 400 ml
T 8.18.0I	T 8.18.0I 47	T 8.18.0I	T 8.18.0I 44
SPRAY ISOLANTE ANTI-ADERENTE SOLDADURA	SPRAY ISOLANTE ANTI-ADERENTE COM SILICONE	SPRAY ISOLANTE ANTI-ADERENTE SEM SILICONE	SPRAY ISOLANTE PROTETOR CEROSO MOLDES
 Ref.ª 0975	 Ref.ª 2810	 Ref.ª 0195	 Ref.ª 0175
SPRAY 400 ml	SPRAY 400 ml	SPRAY 400 ml	SPRAY 400 ml
T 8.18.0J 41	T 8.18.0J	T 8.18.0J	T 8.18.0J
SPRAY ISOLANTE PROTETOR ANTIFERRUGEM ÓLEO	SPRAY DE LIMPEZA DETERGENTE SUPER CLEANER	SPRAY DE LIMPEZA DETERGENTE INDUSTRIAL	SPRAY DE LIMPEZA PARA POLIR AÇO INOX
 Ref.ª 0180	 Ref.ª 3125	 Ref.ª 0105	 Ref.ª 2795
SPRAY 400 ml	SPRAY 400 ml	SPRAY 400 ml	SPRAY 400 ml
T 8.18.0J 26	T 8.18.0K	T 8.18.0K	T 8.18.0K 38
SPRAY DE LIMPEZA SOLVENTE ESPUMA POLIURETANO	SPRAY DE LIMPEZA REMOVE COLA E ETIQUETAS	SPRAY DE LIMPEZA REMOVEDOR DE SILICONE	PRODUTO DE LIMPEZA DESENTUPIDOR DE CANOS
 Ref.ª 0065	 Ref.ª 0140	 Ref.ª 0090	 Ref.ª 1725
SPRAY 500 ml	SPRAY 200 ml	SPRAY 400 ml	RECIPIENTE 1 L
T 8.18.0K	T 8.18.0K	T 8.18.0L 74	T 8.18.0L
SPRAY DE LIMPEZA HIGIENIZANTE AR CONDICIONADO	SPRAY DE LIMPEZA AR COMPRIMIDO AIR DUSTER	SPRAY DE LIMPEZA TRAVÕES E EMBRAIAGENS	MASSA LAVA-MÃOS AMARELA
 Ref.ª 3130	 Ref.ª 0110	 Ref.ª 0075	 TechSol
SPRAY 400 ml	SPRAY 400 ml	SPRAY 500 ml	BALDE 1 kg e 4 kg
T 8.18.0L 16	T 8.18.0L	T 8.18.0L 39	T 8.18.0M





GRUPO 8 QUÍMICOS (SILICONES, RESINAS E SPRAYS)

ÍNDICE 8.7

MASSA LAVA-MAOS BRANCA-PLUS	SPRAY DE COLA PERMANENTE MULTIUSOS	COLA DE CIANOACRILATO FLASH 100	COLA DE CIANOACRILATO FLASH 200
<p style="writing-mode: vertical-rl; transform: rotate(180deg);">Grupo: 8</p>  <p style="text-align: right;">TechSol</p>	<p style="writing-mode: vertical-rl; transform: rotate(180deg);">Grupo: 8</p>  <div style="text-align: right;">  Ref.ª 0695 </div>	<p style="writing-mode: vertical-rl; transform: rotate(180deg);">Grupo: 8</p>  <div style="text-align: right;">  Ref.ª 0675 </div>	<p style="writing-mode: vertical-rl; transform: rotate(180deg);">Grupo: 8</p>  <div style="text-align: right;">  Ref.ª 0680 </div>
BALDE 1 kg e 4 kg	SPRAY 400 ml	TUBO 10g e 20g	TUBO 10g e 20g
T 8.18.0MA	T 8.18.0N	T 8.18.0N	T 8.18.0N

STICKS DE COLA TERMOFUSÍVEL	PISTOLAS PARA COLA TERMOFUSÍVEL	PISTOLAS PARA COLA TERMOFUSÍVEL	PISTOLAS PARA COLA TERMOFUSÍVEL
<p style="writing-mode: vertical-rl; transform: rotate(180deg);">Grupo: 8</p>  <div style="text-align: right;">  REACH (CE) n.º 1907/2006 </div>	<p style="writing-mode: vertical-rl; transform: rotate(180deg);">Grupo: 8</p> <div style="text-align: center;"> <p>GRIP 15HL</p>  <div style="text-align: right;">  40 Watts </div> </div>	<p style="writing-mode: vertical-rl; transform: rotate(180deg);">Grupo: 8</p> <div style="text-align: center;"> <p>GRIP 18HP</p>  <div style="text-align: right;">  60 Watts </div> </div>	<p style="writing-mode: vertical-rl; transform: rotate(180deg);">Grupo: 8</p> <div style="text-align: center;"> <p>GRIP 20XP</p>  <div style="text-align: right;">  80 Watts </div> </div>
TRANSPARENTE	BRICOLAGE	BRICOLAGE	BRICOLAGE
T 8.20	T 8.20	T 8.20	T 8.20

PISTOLAS PARA COLA TERMOFUSÍVEL			
<p style="writing-mode: vertical-rl; transform: rotate(180deg);">Grupo: 8</p> <div style="text-align: center;"> <p>M 195</p>  <div style="text-align: right;">  120 Watts </div> </div>			
PROFISSIONAL / INDUSTRIAL			
T 8.20			



GRUPO 9 CORRENTES, CABOS E ACESSÓRIOS



ÍNDICE 9.2

GANCHOS DE CARGA GIRATÓRIOS		MOITÃO 1 RODA ZAMAK - RODA NYLON		MOITÃO 2 RODAS ZAMAK - RODAS NYLON		MOITÃO 1 RODA ZAMAK - DESTORCEDOR	
Grupo: 9		Grupo: 9		Grupo: 9		Grupo: 9	
	ÁÇO		ZAMAK		ZAMAK		ZAMAK
PINTADO	T 9.6	T 9.6 A	T 9.6 A	T 9.6 A			



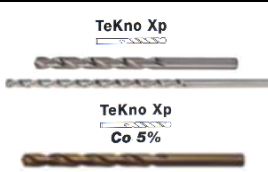

ESTICADOR NÁUTICO		ESTICADOR BRANDAL NÁUTICO		TERMINAL BRANDAL		TERMINAL ROSCADO	
Grupo: 9		Grupo: 9		Grupo: 9		Grupo: 9	
	INOX A4		INOX A4		INOX A4		INOX A4
T 9.7	T 9.7	T 9.7	T 9.8				





TERMINAL COM OLHAL		DESTORCEDOR OLHAL-OLHAL					
Grupo: 9		Grupo: 9					
	INOX A4		ÁÇO	INOX A4			
T 9.8	ZINCADO	T 9.8	T 9.8				





		<h2 style="color: green;">GRUPO 11</h2> <h3 style="color: green;">CONSUMÍVEIS (BROCAS, DISCOS, ETC...)</h3>	<h2 style="color: green;">ÍNDICE 11.1</h2>
--	---	---	--

BROCAS - DIN 338 E FITAS DE SERRA	BROCAS DE AÇO RÁPIDO DIN 338 - ECEF	BROCAS DE AÇO RÁPIDO LONGAS - ECEF	BROCAS CRANEANAS - ECEF E ACESSÓRIOS																		
<p style="writing-mode: vertical-rl; transform: rotate(180deg);">Grupo: 11</p> 	<p style="writing-mode: vertical-rl; transform: rotate(180deg);">Grupo: 11</p> 	<p style="writing-mode: vertical-rl; transform: rotate(180deg);">Grupo: 11</p> 	<p style="writing-mode: vertical-rl; transform: rotate(180deg);">Grupo: 11</p> 																		
<table border="1" style="width: 100%; border-collapse: collapse;"> <tr> <td style="width: 50%;">BROCAS HSS</td> <td style="width: 50%;">BROCAS HSS-Co8%</td> </tr> <tr> <td>T 11.1</td> <td>T 11.1</td> </tr> </table>	BROCAS HSS	BROCAS HSS-Co8%	T 11.1	T 11.1	<table border="1" style="width: 100%; border-collapse: collapse;"> <tr> <td style="width: 33%;">LAMINADAS</td> <td style="width: 33%;">RETIFICADAS</td> <td style="width: 33%;">FRESADAS</td> </tr> <tr> <td>T 11.1 A</td> <td>T 11.1 A</td> <td>T 11.1 A</td> </tr> </table>	LAMINADAS	RETIFICADAS	FRESADAS	T 11.1 A	T 11.1 A	T 11.1 A	<table border="1" style="width: 100%; border-collapse: collapse;"> <tr> <td colspan="2">TeKno Xp LONGAS E EXTRALONGAS</td> </tr> <tr> <td style="width: 50%;">LONGAS - DIN 340</td> <td style="width: 50%;">T 11.1 AA</td> </tr> <tr> <td>EXTRALONGAS- DIN 1869</td> <td>T 11.1 AA</td> </tr> <tr> <td>LONGAS Co 5% - DIN 340</td> <td>T 11.1 AA</td> </tr> </table>	TeKno Xp LONGAS E EXTRALONGAS		LONGAS - DIN 340	T 11.1 AA	EXTRALONGAS- DIN 1869	T 11.1 AA	LONGAS Co 5% - DIN 340	T 11.1 AA	AÇO HSS BIMETÁLICO T 11.1 B
BROCAS HSS	BROCAS HSS-Co8%																				
T 11.1	T 11.1																				
LAMINADAS	RETIFICADAS	FRESADAS																			
T 11.1 A	T 11.1 A	T 11.1 A																			
TeKno Xp LONGAS E EXTRALONGAS																					
LONGAS - DIN 340	T 11.1 AA																				
EXTRALONGAS- DIN 1869	T 11.1 AA																				
LONGAS Co 5% - DIN 340	T 11.1 AA																				
<table border="1" style="width: 100%; border-collapse: collapse;"> <tr> <td colspan="2">FITAS DE SERRA AÇO AISI M 42-8%Co</td> </tr> <tr> <td colspan="2">T 11.1</td> </tr> </table>		FITAS DE SERRA AÇO AISI M 42-8%Co		T 11.1		<table border="1" style="width: 100%; border-collapse: collapse;"> <tr> <td style="width: 33%;">GOLD-BLACK</td> <td style="width: 33%;">Co 5%</td> <td style="width: 33%;">Co 8%</td> </tr> <tr> <td>T 11.1 A</td> <td>T 11.1 A</td> <td>T 11.1 A</td> </tr> </table>		GOLD-BLACK	Co 5%	Co 8%	T 11.1 A	T 11.1 A	T 11.1 A								
FITAS DE SERRA AÇO AISI M 42-8%Co																					
T 11.1																					
GOLD-BLACK	Co 5%	Co 8%																			
T 11.1 A	T 11.1 A	T 11.1 A																			

BROCAS DE FRESA - ECEF P/ BASE ELECTROMAGNÉTICA	JOGOS 3 MACHOS MANUAIS ROSCA MÉTRICA - PASSO NORMAL	MACHO MANUAL CORTE FINAL ROSCA MÉTRICA - PASSO NORMAL	JOGOS 2 MACHOS MANUAIS ROSCA MÉTRICA - PASSO FINO
<p style="writing-mode: vertical-rl; transform: rotate(180deg);">Grupo: 11</p> 	<p style="writing-mode: vertical-rl; transform: rotate(180deg);">Grupo: 11</p> 	<p style="writing-mode: vertical-rl; transform: rotate(180deg);">Grupo: 11</p> 	<p style="writing-mode: vertical-rl; transform: rotate(180deg);">Grupo: 11</p> 
AÇO HSS-G M2+Al - CBN-fresado T 11.1 C	AÇO C.V. - AÇO HSS-G T 11.1 D	AÇO C.V. - AÇO HSS-G T 11.1 D	AÇO C.V. - AÇO HSS-G T 11.1 D

VIRA-MACHOS	CAÇONETES AJUSTÁVEIS ROSCA MÉTRICA NORMAL + FINA	PORTA-CAÇONETES DIN 225	SET DE MACHOS MANUAIS ROSCA MÉTRICA NORMAL
<p style="writing-mode: vertical-rl; transform: rotate(180deg);">Grupo: 11</p> 	<p style="writing-mode: vertical-rl; transform: rotate(180deg);">Grupo: 11</p> 	<p style="writing-mode: vertical-rl; transform: rotate(180deg);">Grupo: 11</p> 	<p style="writing-mode: vertical-rl; transform: rotate(180deg);">Grupo: 11</p> 
AJUSTÁVEIS - COM ROQUETE SEM ROQUETE T 11.1 D	AÇO C.V. - AÇO HSS-G T 11.1 F	DIN 225 T 11.1 F	21 MACHOS - AÇO HSS-G T 11.1 G

SET MACHOS + CAÇONETES ROSCA MÉTRICA NORMAL	EXTRATORES DE PARAFUSOS	MACHOS MÁQUINA - FORMA B ROSCA MÉTRICA NORMAL	MACHOS MÁQUINA - FORMA C ROSCA MÉTRICA NORMAL																								
<p style="writing-mode: vertical-rl; transform: rotate(180deg);">Grupo: 11</p> 	<p style="writing-mode: vertical-rl; transform: rotate(180deg);">Grupo: 11</p> 	<p style="writing-mode: vertical-rl; transform: rotate(180deg);">Grupo: 11</p> 	<p style="writing-mode: vertical-rl; transform: rotate(180deg);">Grupo: 11</p> 																								
32 PEÇAS - AÇO HSS-G T 11.1 G	AÇO Cr-V T 11.1 G	<table border="1" style="width: 100%; border-collapse: collapse;"> <tr> <td colspan="2">DIN 371/B</td> <td colspan="2">DIN 376/B</td> </tr> <tr> <td>HSS-Co</td> <td>HSS-G</td> <td>HSS-Co</td> <td>HSS-G</td> </tr> <tr> <td colspan="2">T 11.1 H</td> <td colspan="2">T 11.1 H</td> </tr> </table>	DIN 371/B		DIN 376/B		HSS-Co	HSS-G	HSS-Co	HSS-G	T 11.1 H		T 11.1 H		<table border="1" style="width: 100%; border-collapse: collapse;"> <tr> <td colspan="2">DIN 371/C</td> <td colspan="2">DIN 376/C</td> </tr> <tr> <td>HSS-Co</td> <td>HSS-G</td> <td>HSS-Co</td> <td>HSS-G</td> </tr> <tr> <td colspan="2">T 11.1 H</td> <td colspan="2">T 11.1 H</td> </tr> </table>	DIN 371/C		DIN 376/C		HSS-Co	HSS-G	HSS-Co	HSS-G	T 11.1 H		T 11.1 H	
DIN 371/B		DIN 376/B																									
HSS-Co	HSS-G	HSS-Co	HSS-G																								
T 11.1 H		T 11.1 H																									
DIN 371/C		DIN 376/C																									
HSS-Co	HSS-G	HSS-Co	HSS-G																								
T 11.1 H		T 11.1 H																									

MACHOS MÁQUINA - FORMA C 15° - ROSCA MÉTRICA NORMAL	MACHOS MÁQUINA - FORMA C 35° - ROSCA MÉTRICA NORMAL	UTENSÍLIO COMBINADO FURAR - ROSCAR - ESCARIAR	FRESAS ROTATIVAS - CORTE A DIAMANTE -																								
<p style="writing-mode: vertical-rl; transform: rotate(180deg);">Grupo: 11</p> 	<p style="writing-mode: vertical-rl; transform: rotate(180deg);">Grupo: 11</p> 	<p style="writing-mode: vertical-rl; transform: rotate(180deg);">Grupo: 11</p> 	<p style="writing-mode: vertical-rl; transform: rotate(180deg);">Grupo: 11</p> 																								
AÇO HSS-Co - Para INOX	AÇO HSS-Co - Para INOX	Jogo de 6 utensílios Caixa metálica	METAL DURO K20																								
<table border="1" style="width: 100%; border-collapse: collapse;"> <tr> <td colspan="2">DIN 371/C 15°</td> <td colspan="2">DIN 376/C 15°</td> </tr> <tr> <td>HSS-Co</td> <td>HSS-G</td> <td>HSS-Co</td> <td>HSS-G</td> </tr> <tr> <td colspan="2">T 11.1 H</td> <td colspan="2">T 11.1 H</td> </tr> </table>	DIN 371/C 15°		DIN 376/C 15°		HSS-Co	HSS-G	HSS-Co	HSS-G	T 11.1 H		T 11.1 H		<table border="1" style="width: 100%; border-collapse: collapse;"> <tr> <td colspan="2">DIN 371/C 35°</td> <td colspan="2">DIN 376/C 35°</td> </tr> <tr> <td>HSS-Co</td> <td>HSS-G</td> <td>HSS-Co</td> <td>HSS-G</td> </tr> <tr> <td colspan="2">T 11.1 H</td> <td colspan="2">T 11.1 H</td> </tr> </table>	DIN 371/C 35°		DIN 376/C 35°		HSS-Co	HSS-G	HSS-Co	HSS-G	T 11.1 H		T 11.1 H		AÇO HSS-G T 11.1 M	METAL DURO K20 T 11.1 M
DIN 371/C 15°		DIN 376/C 15°																									
HSS-Co	HSS-G	HSS-Co	HSS-G																								
T 11.1 H		T 11.1 H																									
DIN 371/C 35°		DIN 376/C 35°																									
HSS-Co	HSS-G	HSS-Co	HSS-G																								
T 11.1 H		T 11.1 H																									

		<h2 style="color: green;">GRUPO 11</h2> <h3 style="color: green;">CONSUMÍVEIS (BROCAS, DISCOS, ETC...)</h3>	<h2 style="color: green;">ÍNDICE 11.2</h2>
--	---	---	--

DISCOS DIAMANTADOS SINTERIZADOS	DISCOS DIAMANTADOS SINTERIZADOS	DISCOS DIAMANTADOS SINTERIZADOS	DISCOS DIAMANTADOS SINTERIZADOS
<p style="color: blue; font-size: small;">Grupo: 11</p>  <p style="color: blue; font-size: small; transform: rotate(-15deg); position: absolute; top: 10px; right: 10px;">Materiais de construção Betão</p>	<p style="color: blue; font-size: small;">Grupo: 11</p>  <p style="color: blue; font-size: small; transform: rotate(-15deg); position: absolute; top: 10px; right: 10px;">Mármore/ Cerâmica</p>	<p style="color: blue; font-size: small;">Grupo: 11</p>  <p style="color: blue; font-size: small; transform: rotate(-15deg); position: absolute; top: 10px; right: 10px;">Granito</p>	<p style="color: blue; font-size: small;">Grupo: 11</p>  <p style="color: blue; font-size: small; transform: rotate(-15deg); position: absolute; top: 10px; right: 10px;">Betão</p>
SEGMENTADOS - CCS 101	BANDA CONTÍNUA - CCC 101	TURBO - CCT 201	SEGMENTADOS - CCS 111
T 11.2	T 11.2	T 11.2	T 11.2

DISCOS DIAMANTADOS SINTERIZADOS	DISCOS DIAMANTADOS LASER	DISCOS DIAMANTADOS LASER	DISCOS DIAMANTADOS LASER
<p style="color: blue; font-size: small;">Grupo: 11</p>  <p style="color: blue; font-size: small; transform: rotate(-15deg); position: absolute; top: 10px; right: 10px;">Corte rápido Betão</p>	<p style="color: blue; font-size: small;">Grupo: 11</p>  <p style="color: blue; font-size: small; transform: rotate(-15deg); position: absolute; top: 10px; right: 10px;">Materiais de construção</p>	<p style="color: blue; font-size: small;">Grupo: 11</p>  <p style="color: blue; font-size: small; transform: rotate(-15deg); position: absolute; top: 10px; right: 10px;">Granito</p>	<p style="color: blue; font-size: small;">Grupo: 11</p>  <p style="color: blue; font-size: small; transform: rotate(-15deg); position: absolute; top: 10px; right: 10px;">Betão</p>
SEGMENTADOS - CCS 107	SEGMENTADOS CLS 111, CLS 117	SEGMENTADOS - CLS 121	SEGMENTADOS - CLS 231
T 11.3	T 11.3	T 11.3	T 11.3

DISCOS ABRASIVOS P/ CORTAR E REBARBAR	DISCOS LAMELARES	RODAS LAMELARES COM ESIÇA	DISCOS ABRASIVOS P/ CORTAR E REBARBAR
<p style="color: blue; font-size: small;">Grupo: 11</p> 	<p style="color: blue; font-size: small;">Grupo: 11</p> 	<p style="color: blue; font-size: small;">Grupo: 11</p> 	<p style="color: blue; font-size: small;">Grupo: 11</p> 
CORTAR REBARBAR			CORTAR REBARBAR
FERRO T 11.4 T 11.4			FERRO T 11.4 A T 11.4 A
INOX T 11.4	T 11.4	T 11.4 0A	INOX T 11.4 A
PEDRA T 11.4			PEDRA T 11.4 A

DISCOS LAMELARES	ESCOVA TAÇA DE FIOS ENTRANÇADOS	ESCOVA TAÇA DE FIOS ONDULADOS	ESCOVA TAÇA DE NYLON ABRASIVO
<p style="color: blue; font-size: small;">Grupo: 11</p> 	<p style="color: blue; font-size: small;">Grupo: 11</p> 	<p style="color: blue; font-size: small;">Grupo: 11</p> 	<p style="color: blue; font-size: small;">Grupo: 11</p> 
T 11.4 A	AÇO INOX	AÇO INOX LATÃO	NYLON
	T 11.4 A 1 T 11.4 A 1	T 11.4 A 1 T 11.4 A 1 T 11.4 A 1	T 11.4 A 1

ESCOVA CÔNICA DE FIOS ENTRANÇADOS	ESCOVA CÔNICA DE FIOS ONDULADOS	ESCOVA CIRCULAR DE FIOS ENTRANÇADOS	ESCOVA CIRCULAR DE FIOS ENTRANÇADOS
<p style="color: blue; font-size: small;">Grupo: 11</p> 	<p style="color: blue; font-size: small;">Grupo: 11</p> 	<p style="color: blue; font-size: small;">Grupo: 11</p> 	<p style="color: blue; font-size: small;">Grupo: 11</p> 
AÇO	AÇO LATÃO	AÇO	AÇO INOX
T 11.4 A 2	T 11.4 A 2 T 11.4 A 2	T 11.4 A 2	T 11.4 A 2 T 11.4 A 3



GRUPO 11 CONSUMÍVEIS (BROCAS, DISCOS, ETC...)





ÍNDICE 11.3





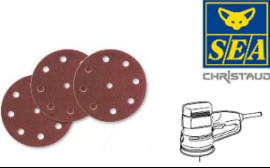

ESCOVA CIRCULAR DE FIOS ONDULADOS		ESCOVA CIRCULAR DE NYLON ABRASIVO		ESCOVA CIRCULAR DE POLÍMERO ABRASIVO		ESCOVA CIRCULAR DE POLIR EM ALGODÃO			
Grupo: 11			Grupo: 11			Grupo: 11			
	AÇO	LATÃO		NYLON	NYLON + CARBONETO DE SILÍCIO		ALGODÃO		
	T 11.4 A 3	T 11.4 A 3		T 11.4 A 3	T 11.4 A 3		T 11.4 A 3		
ESCOVA PINCEL AÇO ENTRANÇADO		ESCOVA PINCEL DE FIOS ONDULADOS		ESCOVA PINCEL DE NYLON ABRASIVO		ESCOVA TAÇA DE ESPIGA DE FIOS ONDULADOS			
Grupo: 11			Grupo: 11			Grupo: 11			
	AÇO	INOX		AÇO	LATÃO		AÇO	LATÃO	
	T 11.4 A 4	T 11.4 A 4		T 11.4 A 4	T 11.4 A 4		T 11.4 A 5	T 11.4 A 5	
ESCOVA TAÇA DE ESPIGA DE NYLON ABRASIVO		ESCOVA CIRCULAR DE ESPIGA AÇO ENTRANÇADO		ESCOVA CIRCULAR DE ESPIGA DE FIOS ONDULADOS		ESCOVA CIRCULAR DE ESPIGA EM NYLON ABRASIVO			
Grupo: 11			Grupo: 11			Grupo: 11			
	NYLON	AÇO		AÇO	INOX		LATÃO	NYLON	
	T 11.4 A 5	T 11.4 A 5		T 11.4 A 6	T 11.4 A 6		T 11.4 A 6	T 11.4 A 6	
ESCOVA CIRCULAR DE ESPIGA EM POLÍMERO ABRASIVO		ESCOVA CIRCULAR DE ESPIGA DE POLIR EM ALGODÃO		ESCOVA CIRCULAR DE ESPIGA EM AÇO ENCAPSULADO		ESCOVA MANUAL			
Grupo: 11			Grupo: 11			Grupo: 11			
	NYLON + CARBONETO DE SILÍCIO	ALGODÃO		AÇO	AÇO		INOX	AÇO LATONADO	NYLON
	T 11.4 A 6	T 11.4 A 7		T 11.4 A 7	T 11.4 A 7		T 11.4 A 7	T 11.4 A 7	T 11.4 A 7
KITS DE ANEIS DE REDUÇÃO		FOLHAS DE LIXA TRABALHOS À MÃO		FOLHAS DE LIXA AUTOADERENTES - P/ BLOCO		ROLOS DE LIXA MÃO - MÁQUINA			
Grupo: 11			Grupo: 11			Grupo: 11			
	PLÁSTICO [mm / "]	230 x 280 mm		73 x 123 mm	120 mm x 50 m				
	T 11.4 A 7	T 11.4 C		T 11.4 D	T 11.4 E				



GRUPO 11 CONSUMÍVEIS (BROCAS, DISCOS, ETC...)

ÍNDICE 11.4

FOLHAS DE LIXA AUTOADERENTES - MÁQUINA	DISCOS DE LIXA AUTOADERENTES	DELTAS DE LIXA AUTOADERENTES	BROCAS STANDARD - ECEF PARA BETÃO / PEDRA
<p>Grupo: 11</p> 	<p>Grupo: 11</p> 	<p>Grupo: 11</p> 	<p>Grupo: 11</p> <p>ECEF </p> <p>STANDARD</p> 
PRO® 115 x 228 mm	Ø 115 - Ø 125 - Ø150	93x93x93 - 105x105x105 PRO® 100x147 - 100x165 - 100x150	T 11.5 A
T 11.4 E	T 11.4 F	T 11.4 G	

BROCAS STANDARD - ECEF PARA BETÃO / PEDRA	BROCAS PARA MARTELOS SDS+	BROCAS PARA MARTELOS SDS+ BOOSTER PLUS	BROCAS PARA MARTELOS SDS+ "TRI-STAR"
<p>Grupo: 11</p> <p>ECEF SUPER</p> <p>PROFISSIONAL</p> 	<p>Grupo: 11</p> <p>DIAGER</p> 	<p>Grupo: 11</p> <p>DIAGER</p> 	<p>Grupo: 11</p> <p>ECEF </p>  
T 11.5 A	T 11.6	T 11.6	T 11.6 0A

BROCAS PARA MARTELOS SDS PLUS - ECEF	BROCAS PARA MARTELOS SDS MAX	CINZEIS E ESCOPROS P/ MARTELOS SDS+ e SDS MAX	CINZEIS E ESCOPROS P/ MARTELOS SDS+ e SDS MAX																		
<p>Grupo: 11</p> <p>ECEF DUPLO CANAL</p>  <p>ECEF </p> 	<p>Grupo: 11</p> <p>DIAGER</p> 	<p>Grupo: 11</p> <p>DIAGER</p> 	<p>Grupo: 11</p> <p>ECEF </p> 																		
T 11.6 A	T 11.7	<table border="1" style="width: 100%; border-collapse: collapse;"> <thead> <tr> <th></th> <th>CINZEIS</th> <th>ESCOPROS</th> </tr> </thead> <tbody> <tr> <td>SDS +</td> <td style="text-align: center;">T 11.7</td> <td style="text-align: center;">T 11.7</td> </tr> <tr> <td>SDS MAX</td> <td style="text-align: center;">T 11.7</td> <td style="text-align: center;">T 11.7</td> </tr> </tbody> </table>		CINZEIS	ESCOPROS	SDS +	T 11.7	T 11.7	SDS MAX	T 11.7	T 11.7	<table border="1" style="width: 100%; border-collapse: collapse;"> <thead> <tr> <th></th> <th>CINZEIS</th> <th>ESCOPROS</th> </tr> </thead> <tbody> <tr> <td>SDS +</td> <td style="text-align: center;">T 11.7 0A</td> <td style="text-align: center;">T 11.7 0A</td> </tr> <tr> <td>SDS MAX</td> <td style="text-align: center;">T 11.7 0A</td> <td style="text-align: center;">T 11.7 0A</td> </tr> </tbody> </table>		CINZEIS	ESCOPROS	SDS +	T 11.7 0A	T 11.7 0A	SDS MAX	T 11.7 0A	T 11.7 0A
	CINZEIS	ESCOPROS																			
SDS +	T 11.7	T 11.7																			
SDS MAX	T 11.7	T 11.7																			
	CINZEIS	ESCOPROS																			
SDS +	T 11.7 0A	T 11.7 0A																			
SDS MAX	T 11.7 0A	T 11.7 0A																			

BROCAS PARA MARTELOS SDS MAX - ECEF	BROCA ESPECIAL PARA GRÉS - ECEF	BROCA/FRESA DIAMANTADA E ACESSÓRIOS - ECEF	GAMA COMPLETA DE LIXAS TRABALHOS À MÃO / MÁQUINA
<p>Grupo: 11</p> <p>ECEF </p> <p>Y-CUTTER® SDS-MAX</p>  	<p>Grupo: 11</p> <p>ECEF</p> 	<p>Grupo: 11</p> <p>ECEF</p> 	<p>Grupo: 11</p>  <p>INDASA</p> <p>DISCOS - FOLHAS ROLOS - ESPONJAS</p>
T 11.7 A	T 11.7 B	T 11.7 B	T 11.09

DISCOS DE LIXA RHYNOGRIP WHITE LINE	DISCOS DE LIXA RHYNOGRIP WHITE LINE	DISCOS DE LIXA RHYNOFIBRE 'A' SILVER	ACESSÓRIOS PARA DISCOS DE LIXA
<p>Grupo: 11</p>  <p></p> <p>INDASA</p>	<p>Grupo: 11</p>  <p></p> <p>INDASA</p>	<p>Grupo: 11</p>  <p></p> <p>INDASA</p>	<p>Grupo: 11</p>  <p></p> <p>INDASA</p>
Papel C e D Óxido de Alumínio	Papel C e D Óxido de Alumínio	Fibra vulcanizada Óxido de Alumínio	Pratos - Interfaces
T 11.9	T 11.10	T 11.11	T 11.12



GRUPO 11 CONSUMÍVEIS (BROCAS, DISCOS, ETC...)

ÍNDICE 11.5

	FOLHAS DE LIXA RHYNOWET PLUS LINE	FOLHAS DE LIXA RHYNOWET WHITE LINE	FOLHAS DE LIXA RHYNALOX WHITE LINE	FOLHAS DE LIXA RHYNODRY WHITE LINE
Grupo: 11				
	Papel C,A Latex Óx. Alumínio / Carb. Silício	Papel C Óxido de Alumínio	Papel D Óxido de Alumínio	Papel C e A Óxido de Alumínio
	T 11.13	T 11.13	T 11.14	T 11.14

	FOLHAS DE LIXA RHYNOWOOD	FOLHAS DE LIXA RHYNOBLUE	FOLHAS DE LIXA RHYNOMETAL	ROLOS DE LIXA RHYNOMETAL
Grupo: 11				
	Papel B Óxido de Alumínio	Tela de algodão Óxido de Alumínio	Tela de algodão F Óxido de Alumínio	Tela de algodão F Óxido de Alumínio
	T 11.14	T 11.14	T 11.14	T 11.15

	ROLOS DE LIXA RHYNO X/A	ESPONJAS DE LIXA RHYNOSOFT PRE-CUT	ESPONJAS DE LIXA AUTO DUPLA FACE	ESPONJAS DE LIXA AUTO
Grupo: 11				
	Tela de algodão X Óxido de Alumínio	Papel B e C - Latex+Esponja Óxido de Alumínio	Esponja Óxido de Alumínio	Esponja Óxido de Alumínio
	T 11.15	T 11.16	T 11.16	T 11.16

	ESPONJAS DE LIXA DUPLA FACE (madeira)	ESPONJAS DE LIXA TACOS 4 FACES		
Grupo: 11				
	Esponja Óxido de Alumínio	Esponja Óxido de Alumínio		
	T 11.16	T 11.16		



GRUPO 12 FERRAMENTAS MANUAIS

ÍNDICE 12.1

BITS FENDA		BITS PHILIPS				BITS POZIDRIVE				BITS TORX®			
Grupo: 12													
	STANDARD	LONGO	Standard	Ext Duro	E.D.Chapa	Diamante	Standard	Ext Duro	Titânio	Diamante	STANDARD	ST. LONGO	ZONA TORÇ.
	T 12.1	T 12.1	T 12.1	T 12.1	T 12.1	T 12.1	T 12.2	T 12.2	T 12.2	T 12.2	T 12.2 A	T 12.2 A	T 12.2 A
			E.D.Longo	E.D.Ch.L.	St. Longo		E.D.Longo	E.D.Ch.L.	St. Longo		CÔNICO		
		T 12.1	T 12.1	T 12.1		T 12.2	T 12.2	T 12.2		T 12.2 A			

BITS TORX® INVIOLÁVEL		BITS SEXTAVADOS		ADAPTADORES PORTA-BITS		CHAVES PORTA-BITS		
Grupo: 12								
	STANDARD		STANDARD		UNIVERSAL	APERTO RÁPIDO	STANDARD	COM DEPÓSITO
	T 12.2 A		T 12.3		T 12.3	T 12.3	T 12.3	T 12.3

CONJUNTO BITS BIT-CHECK 12 METAL 1		CONJUNTO BITS BIT-CHECK 30 METAL 1		JOGOS DE CHAVES SEXTAVADAS		CHAVES DE CAIXA SEXTAVADAS		
Grupo: 12								
	T 12.3 A		T 12.3 A		STANDARD	LONGAS	C/ ÍMAN	S/ ÍMAN
					T 12.6	T 12.6	T 12.6	T 12.6
					LONGAS C/ BOLA	LON. REVEST.BOLA		
				T 12.6	T 12.6			





















ESCORAS DE EXPANSÃO E ACESSÓRIO ARM+		CAVALETE PORTÁTIL		BANDA DE APERTO RETANGULAR		BANDA DE APERTO PARA AROS		
Grupo: 12								
	PIHER		PIHER		PIHER		PIHER	
	T 12.24		T 12.24		T 12.25		T 12.25	

GRAMPOS DE ÊMBOLO ROSCA OCULTA PROTEGIDA		GRAMPOS DE APERTO		GRAMPOS DE ÊMBOLO		GRAMPOS DE ÊMBOLO MODELO S		
Grupo: 12								
	PIHER		PIHER		PIHER		PIHER	
	T 12.26		T 12.26		T 12.27		T 12.27	



GRUPO 12 FERRAMENTAS MANUAIS

ÍNDICE 12.2

GRAMPOS DE APERTO MODELO H		PROTETORES EM PVC		GRAMPOS DE APERTO MODELO DE MADEIRA		GRAMPOS DE APERTO MODELO PAL	
Grupo: 12		Grupo: 12		Grupo: 12		Grupo: 12	
PIHER		PIHER		PIHER		PIHER	
T 12.27		T 12.27		T 12.28		T 12.28	
GRAMPOS DE APERTO RÁPIDO EXTRA QUICK-PIHER		GRAMPOS DE APERTO MODELO GC		CINTA DE APERTO		TORNOS DE BANCADA GUIA QUADRADA	
Grupo: 12		Grupo: 12		Grupo: 12		Grupo: 12	
PIHER		PIHER		PIHER		PIHER	
T 12.28		T 12.28		T 12.28		T 12.29	
ESQUADROS MAGNÉTICOS		MASSA MAGNÉTICA PARA SOLDADURA		PINÇAS PRESSÃO PROGRESSIVA		PINÇAS DE PLÁSTICO AJUSTÁVEIS	
Grupo: 12		Grupo: 12		Grupo: 12		Grupo: 12	
PIHER		PIHER		PIHER		PIHER	
T 12.29		T 12.29		T 12.30		T 12.30	
PINÇAS METÁLICAS		FECHO DE APERTO RÁPIDO GANCHO M4		VENTOSA PROFILAT		VENTOSAS DE PLÁSTICO VEN-1 ; VEN-2	
Grupo: 12		Grupo: 12		Grupo: 12		Grupo: 12	
PIHER		PIHER		PIHER		PIHER	
T 12.30		T 12.30		T 12.31		T 12.31	
VENTOSA DE ALUMIO VENAL1 - VENAL 2 - VENAL 3		TRANSPORTADOR DE PAINÉIS		TRANSPORTADOR ESPECIAL PARA VIDRO		TRANSPORTADOR DE PLÁSTICO	
Grupo: 12		Grupo: 12		Grupo: 12		Grupo: 12	
PIHER		PIHER		PIHER		PIHER	
T 12.31		T 12.32		T 12.32		T 12.32	



GRUPO 12 FERRAMENTAS MANUAIS

ÍNDICE 12.3

NÍVEIS DE BOLHA DE AR		ACESSÓRIOS CONSTRUÇÃO FITA SINALIZADORA		ACESSÓRIOS CONSTRUÇÃO TIRA LINHAS		INSTRUMENTOS MEDIÇÃO FITAS MÉTRICAS	
Grupo: 12		Grupo: 12		Grupo: 12		Grupo: 12	
VOLA		VOLA		VOLA		VOLA	
T 12.33		T 12.33		T 12.33		T 12.34	
INSTRUMENTOS MEDIÇÃO RIGOROSA - PAQUÍMETRO		FERRAMENTAS DE CORTE X-ATOS		ESQUADROS PARA CARPINTEIROS		EasyCross-Laser Green Set	
Grupo: 12		Grupo: 12		Grupo: 12		Grupo: 12	
VOLA		VOLA		VOLA		Laserliner	
T 12.34		T 12.35		T 12.35		T 12.36	
CompactPlane-Laser 3G Set 150		TRIPIÉ FixPod 155 cm		TRIPIÉ VarioStand L 120 cm		MEDIDOR DE DISTÂNCIAS LaserRange-Master i5	
Grupo: 12		Grupo: 12		Grupo: 12		Grupo: 12	
Laserliner		Laserliner		Laserliner		Laserliner	
T 12.36		T 12.37		T 12.37		T 12.38	
MEDIDOR DE DISTÂNCIAS LaserRange-Master i3		HODÓMETRO RollPilot S12		NÍVEIS ELETRÔNICOS DigiLevel Plus		MEDIDOR DE ÂNGULOS ArcoMaster	
Grupo: 12		Grupo: 12		Grupo: 12		Grupo: 12	
Laserliner		Laserliner		Laserliner		Laserliner	
T 12.38		T 12.39		T 12.39		T 12.40	
NÍVEIS ELETRÔNICOS DigiLevel Pro		MEDIDOR DE TEMPERATURA ThermoSpot Pocket		DETETOR DE CABOS ActiveFinder		VERIFICADOR DE TENSÃO ActiveMaster	
Grupo: 12		Grupo: 12		Grupo: 12		Grupo: 12	
Laserliner		Laserliner		Laserliner		Laserliner	
T 12.40		T 12.41		T 12.41		T 12.42	



GRUPO 12 FERRAMENTAS MANUAIS

















ÍNDICE 12.4

MEDIDOR DE TENSÃO MultiClamp-Meter Pro		MULTÍMETRO MultiMeter-Compact		NÍVEIS DE BOLHA DE AR Série ZE		NÍVEIS DE BOLHA DE AR Série GE	
Grupo: 12		Grupo: 12		Grupo: 12		Grupo: 12	
	Laserliner		Laserliner		4K5		4K5
	T 12.42		T 12.43		T 12.44		T 12.45
NÍVEIS DE BOLHA DE AR Série GE M		NÍVEIS DE BOLHA DE AR Série ME		NÍVEL DE BOLHA DE AR EL		NÍVEIS DE BOLHA DE AR Série DR	
Grupo: 12		Grupo: 12		Grupo: 12		Grupo: 12	
	4K5		4K5		4K5		4K5
	T 12.45		T 12.46		T 12.46		T 12.46
NÍVEL DE BOLHA DE AR IN		NÍVEL DE BOLHA DE AR HA 10		NÍVEL DE BOLHA DE AR TOP		FITA MÉTRICA RMX 3/5/8	
Grupo: 12		Grupo: 12		Grupo: 12		Grupo: 12	
	4K5		4K5		4K5		4K5
	T 12.47		T 12.47		T 12.47		T 12.48
FITA MÉTRICA LMF 30/50		METRO ARTICULADO FR 2X		MARCADOR MECÂNICO DP 100/101		JOGO LÁPIS DE CARPINTEIRO ZI 240	
Grupo: 12		Grupo: 12		Grupo: 12		Grupo: 12	
	4K5		4K5		4K5		4K5
	T 12.49		T 12.49		T 12.50		T 12.50
CANIVETE MULTIFUNÇÃOAL TK 100		X-ATO DOBRÁVEL TK 300		X-ATO MULTIFUNÇÃOAL UKR		X-ATO COMPACTO CR 9	
Grupo: 12		Grupo: 12		Grupo: 12		Grupo: 12	
	4K5		4K5		4K5		4K5
	T 12.50		T 12.51		T 12.51		T 12.51



GRUPO 12 FERRAMENTAS MANUAIS

ÍNDICE 12.5

X-ATO SÓLIDO CR 18		X-ATO EFICAZ CRX 18		X-ATO FORTE CRX 25		LÂMINAS DE SUBSTITUIÇÃO PARA X-ATOS	
Grupo: 12		Grupo: 12		Grupo: 12		Grupo: 12	
4K5		4K5		4K5		4K5	
T 12.52		T 12.52		T 12.52		T 12.52	
FERRAMENTA MULTIFUNÇÕES MT 400		TESOURA ROBUSTA TS 500		TESOURA ANGULAR TS 501		LANTERNA DE TRABALHO RA 500	
Grupo: 12		Grupo: 12		Grupo: 12		Grupo: 12	 500 lúmen
4K5		4K5		4K5		4K5	
T 12.53		T 12.53		T 12.53		T 12.54	
CANDEEIRO DE TRABALHO FL 800		LANTERNA DE TRABALHO PL 700		LANTERNA DE TRABALHO PL 1000		LANTERNA DE CABEÇA WP 400	
Grupo: 12	 800 lúmen	Grupo: 12	 700 lúmen	Grupo: 12	 1000 lúmen	Grupo: 12	 400 lúmen
4K5		4K5		4K5		4K5	
T 12.54		T 12.54		T 12.54		T 12.55	
LANTERNA DE CABEÇA WP 550		PROJETOR LED PARA OBRAS HD 1500		PROJETOR LED PARA OBRAS HD 2000		PROJETOR LED PARA OBRAS HD 6000 C	
Grupo: 12	 550 lúmen	Grupo: 12	 1500 lúmen	Grupo: 12	 2000 lúmen	Grupo: 12	 6000 lúmen
4K5		4K5		4K5		4K5	
T 12.55		T 12.55		T 12.55		T 12.55	



GRUPO 13 ABRAÇADEIRAS

ÍNDICE 13.1

ABRAÇADEIRAS SEM-FIM DIN 3017			ABRAÇADEIRAS COM BANDA PERFURADA		ABRAÇADEIRAS SUPER				ABRAÇADEIRAS REFORÇADAS COM PORCA <u>M8+M10</u>							
Grupo: 13			Grupo: 13			Grupo: 13					Grupo: 13					
	ZINCADO W1	ZN + INOX W2		INOX A2 W4	BANDA INOX PARAF. ZINC. - W2		BANDA E PARAF. INOX - W4	ZINCADO W1	ZN+INOX W2	INOX A2 W4		INOX A4 W5		ZN W1	INOX 304 W4	INOX 316 W5
	T 13.1	T 13.1		T 13.1	T 13.2		T 13.2	T 13.3	T 13.4	T 13.5		T 13.6	SIMPLES	T13.4	T13.4	T13.4
										ISOFÓNICA	T13.4 A	T13.4 A	T13.4 A			

ABRAÇADEIRAS REFORÇADAS COM PORCA <u>M8</u>			ABRAÇADEIRAS REFORÇADAS "RM" - C/ PORCA <u>M8 OU M10</u>		ABRAÇADEIRAS "FILTUBE" SIMPLES E DUPLAS			ABRAÇADEIRAS GAZ				
Grupo: 13			Grupo: 13			Grupo: 13				Grupo: 13		
		ZINCADO W1		INOX 316	INOX 304			INOX 304			ZINCADO	INOX
	SIMPLES	T13.5		T13.5	T 13.6			T 13.6			T 13.6	T 13.6
ISOFÓNICA	T13.5	T13.5										

ABRAÇADEIRAS COM ESPIGÃO SIMPLES E DUPLAS		ABARCONES COMPLETOS MONTADOS			ABRAÇADEIRAS M6 SIMPLES COM E SEM PARAFUSO		ABRAÇADEIRAS M6 DUPLAS COM E SEM PARAFUSO					
Grupo: 13			Grupo: 13				Grupo: 13			Grupo: 13		
	ZINCADO			ZINCADO	INOX 304	INOX 316		ZINCADO			ZINCADO	
	T 13.7			T 13.7	T 13.7	T13.7		T 13.8			T 13.8	





ABRAÇADEIRA M6 ISOFÓNICA SIMPLES E DUPLA		ACESSÓRIOS PARA ABRAÇADEIRAS			ABRAÇADEIRA GÁSMICA PLAST. PRETO - SIMP. E DUPLA		ABRAÇADEIRA GÁSFIX PLAST. AMARELO - SIMPLES					
Grupo: 13			Grupo: 13				Grupo: 13			Grupo: 13		
	ZINCADO			ZINCADO				ZINCADO			ZINCADO	
	T 13.8			T 13.8				T 13.9			T 13.9	

ABRAÇADEIRAS KVDA		GRAPAS SIMPLES, EM "U", DUPLAS			CINTA PERFURADA ONDULADA		CALHAS PERFURADAS					
Grupo: 13			Grupo: 13				Grupo: 13			Grupo: 13		
	ZINCADO			ZINCADO				ZINCADO	INOX		ZINCADO	
	T 13.9			T 13.9				T 13.9 A	T 13.9 A		T 13.10	



GRUPO 13 ABRAÇADEIRAS

ÍNDICE 13.2

SUORTES PERFURADOS	ESQUADROS PARA CALHAS PERFURADAS	SUORTE BASE PARA CALHAS PERFURADAS	PARAFUSOS PARA CALHAS PERFURADAS
Grupo: 13  PARAFAST	Grupo: 13  PARAFAST	Grupo: 13  PARAFAST	Grupo: 13  PARAFAST
ZINCADO	ZINCADO	ZINCADO	ZINCADO
T 13.11	T 13.11	T 13.11	T 13.12

PORCAS PARA CALHAS PERFURADAS			
Grupo: 13  PARAFAST			
ZINCADO			
T 13.12			



GRUPO 14 EQUIPAMENTOS DE PROTEÇÃO INDIVIDUAL

ÍNDICE 14.1

CALÇADO DE SEGURANÇA MODELO UC-145	CALÇADO DE SEGURANÇA MODELO UC-143	CALÇADO DE SEGURANÇA MODELOS UE-411-1 E EU-411	CALÇADO DE SEGURANÇA MODELOS UR-667 E UR-666
CE EN ISO 20345:2004/A1:2007 S1P	CE EN ISO 20345:2004/A1:2007 S1P	CE EN ISO 20345:2004/A1:2007 S1P	CE EN ISO 20345:2004/A1:2007 S3
BOTA DE BAIXA	SAPATO	BOTA BAIXA, SAPATO	BOTA BAIXA, SAPATO
T14.1	T14.1	T14.2	T14.2 A
CALÇADO DE SEGURANÇA MODELO L-7328	CALÇADO DE SEGURANÇA MODELO L-7501	CALÇADO DE SEGURANÇA MODELO M-8370	CALÇADO DE SEGURANÇA MODELO M-8387
CE EN ISO 20345:2011 S1P SRC	CE EN ISO 20345:2011 S1P SRC	CE EN ISO 20345:2011 S3 SRC - HRO	CE EN ISO 20345:2022 S3S SR CI HI FO HRO NOVO HOT RESISTANT
SAPATO	SAPATO AMARELO - VERDE - VERMELHO	BOTA BAIXA	BOTA BAIXA - SOLDADURA
T14.3	T14.3 0A	T14.3 A	T14.3 A
LUVAS DE PROTEÇÃO MODELOS N119 E N120-G - NITRILO	LUVAS DE PROTEÇÃO MODELOS PV90A E PV91 - PVC	LUVAS DE PROTEÇÃO AMIGO	LUVAS DE PROTEÇÃO DRUZUS
EN388: 2016 4121X RETON	EN388 3121 RETON	EN 388 HS	EN 388 HS
NITRILO	PVC	BEIHAI, BIGNET	INPAC, BIGNET
T14.4	T14.5	T14.6	T14.6
LUVAS DE PROTEÇÃO MONTECARLO	LUVAS DE PROTEÇÃO SHETLAND	LUVAS DE PROTEÇÃO KERAX	LUVAS DE PROTEÇÃO GRIPPER
EN 388 HS	EN 388 HS	EN 388 HS	EN 388 HS
INPAC, BIGNET	CLARINO, BIGNET	INPAC, BIGNET	FORWARD, NOVA, CLARINO
T14.7	T14.7	T14.8	T14.8
LUVAS DE PROTEÇÃO SPARTAN	LUVAS DE PROTEÇÃO NITRILE-NYDD 01	LUVAS DE PROTEÇÃO NITRILE-NYSD01	LUVAS DE PROTEÇÃO NITRILE-NYFD01
EN 388 HS	EN 388 HS	EN 388 HS	EN 388 HS
BEIHAI, GelAbsorb	NITRILO	NITRILO	ESPUMA DE NITRILO
T14.9	T14.9	T14.10	T14.10



GRUPO 14 EQUIPAMENTOS DE PROTEÇÃO INDIVIDUAL

ÍNDICE 14.2

LUVAS DE PROTEÇÃO NITRILE-JYFD01		LUVAS DE PROTEÇÃO LATEX-JYD01		LUVAS DE PROTEÇÃO FRIEND		LUVAS DE PROTEÇÃO PRIATEL		
Grupo: 14								
	NITRILO	LATEX	PELE	PELE	NITRILO	LATEX	PELE	PELE
T14.11		T14.11		T14.12		T14.12		
LUVAS DE PROTEÇÃO LATEX - KEVLAR		LUVAS DE PROTEÇÃO HYPROWER PU-HY1		LUVAS DE PROTEÇÃO PU-NY-FD2		LUVAS DE PROTEÇÃO VESUVIUS		
Grupo: 14								
	LATEX, KEVLAR	HYPRO, PU	POLIURETANO	BEIHAI, KEVLAR	LATEX, KEVLAR	HYPRO, PU	POLIURETANO	BEIHAI, KEVLAR
T14.12 0A		T14.12A		T14.12A		T14.12B		
LUVAS DE PROTEÇÃO ETNA		LUVAS DE PROTEÇÃO KRAFLA		LUVAS DE PROTEÇÃO AKAB PVC-JYLD01		LUVAS DE PROTEÇÃO NITRILE - D1		
Grupo: 14								
	BEIHAI, KEVLAR	BEIHAI, KEVLAR	PVC	NITRILO	BEIHAI, KEVLAR	BEIHAI, KEVLAR	PVC	NITRILO
T14.12B		T14.12C		T14.12C		T14.13		
LUVAS DE PROTEÇÃO LATEX - D1		LUVAS DE PROTEÇÃO VYNIL - D1		LUVAS DE PROTEÇÃO SHERPA-PARA MOTOSSERRA		LUVAS DE PROTEÇÃO AGROMASTER		
Grupo: 14								
	LATEX	VINIL	BEIHAI, BIGNET, ARMORTEX, NOVA	BIGNET, SOFTABSORB, PROTECH	LATEX	VINIL	BEIHAI, BIGNET, ARMORTEX, NOVA	BIGNET, SOFTABSORB, PROTECH
T14.13		T14.13		T14.13 A		T14.13 B		
LUVAS DE PROTEÇÃO COLOSSUS		LUVAS DE PROTEÇÃO FIORE		LUVAS DE PROTEÇÃO GRANDE FIORE		LUVAS DE PROTEÇÃO FIORELLE		
Grupo: 14								
	BEIHAI, BIGNET	BEIHAI	BEIHAI	ALGODÃO	BEIHAI, BIGNET	BEIHAI	BEIHAI	ALGODÃO
T14.13 B		T14.13 C		T14.13 C		T14.13 D		



GRUPO 14 EQUIPAMENTOS DE PROTEÇÃO INDIVIDUAL

ÍNDICE 14.3

LUVAS DE PROTEÇÃO NT-Garden	CAPACETE DE SEGURANÇA Ref.ª B201	ÓCULOS DE SEGURANÇA Ref.ª B501	ÓCULOS DE SEGURANÇA Ref.ª B502
			
NITRILE	ABS - 6 PONTOS	POLICARBONATO	POLICARBONATO
T14.13 D	T14.18	T14.18	T14.18 A
ÓCULOS DE SEGURANÇA Ref.ª B507	ÓCULOS DE SEGURANÇA Ref.ª B402	ÓCULOS PARA SOLDAR Ref.ª B408	MÁSCARA DE SOLDAR Ref.ª B303
			
POLICARBONATO	POLICARBONATO	VIDRO MINERAL	POLIPROPILENO
T14.18 A	T14.18 B	T14.18 B	T14.18 C
CAPACETE DE SOLDAR Ref.ª B338	VISEIRA EM MALHA DE AÇO Ref.ª B906SP	MÁSCARA RESPIRATÓRIA Ref.ª B627	MÁSCARA RESPIRATÓRIA Ref.ª B701 FFP1
			
POLIPROPILENO	AÇO E POLICARBONATO	POLIÉSTER	POLIPROPILENO
T14.18 C	T14.18 D	T14.18 D	T14.18 E
MÁSCARA RESPIRATÓRIA Ref.ª B701V FFP1	MÁSCARA RESPIRATÓRIA Ref.ª B702 FFP2	MÁSCARA RESPIRATÓRIA Ref.ª B702V FFP2	PROTETOR AURICULAR Ref.ª B003
			
POLIPROPILENO	POLIPROPILENO	POLIPROPILENO	ABS E POLIACETAL
T14.18 E	T14.18 F	T14.18 F	T14.18 G
PROTETOR AURICULAR Ref.ª B020	PROTETOR AURICULAR Ref.ª B017	PROTETOR AURICULAR Ref.ª B011 - P/CAPACETE	CONJUNTO DE PROTEÇÃO Ref.ª B003, B601, B701
			
ABS E POLIACETAL	ABS E POLIACETAL	ABS E POLIACETAL	AURICULAR, ÓCULOS, MÁSCARA
T14.18 G	T14.18 H	T14.18 H	T14.18 I



GRUPO 14 EQUIPAMENTOS DE PROTEÇÃO INDIVIDUAL

ÍNDICE 14.4

CONJUNTO DE PROTEÇÃO Ref.ª B916, B020	PARKA ALTA VISIBILIDADE VWJK01	BLUSÃO ALTA VISIBILIDADE VWJK04	CONJ. IMPERMEÁVEL ALTA VISIBILIDADE VWJK67 + VWJK68
<p>Grupo: 14</p> 	<p>Grupo: 14</p> 	<p>Grupo: 14</p> 	<p>Grupo: 14</p> 
VISEIRA, AURICULAR	AMARELO	AMARELO	AMARELO
T14.18 I	T14.23 A	T14.23 A	T14.23 B

COLETE ALTA VISIBILIDADE	T-SHIRT ALTA VISIBILIDADE VWTS01-B	CALÇÕES DE TRABALHO MODELO RONA II	
<p>Grupo: 14</p> 	<p>Grupo: 14</p> 	<p>Grupo: 14</p> 	
AMARELO	AMARELO	100% ALGODÃO	
T14.23 C	T14.23 C	T14.24	

VARÃO ROSCADO DIN 975



• AÇO MACIO - 4.8, PRETO E ZINCADO

1, 2 e 3 metros

• AÇO TEMPERADO - 8.8 PRETO, ZINCADO E GALVANIZADO

• AÇO INOX - AISI 304 - A2, AISI 316 - A4



ACABAMENTO	PRETO			ZINCADO				GALVANIZ. A QUENTE	AÇO INOX	
	AÇO MACIO		AÇO TEMPER.	AÇO MACIO			AÇO TEMPER.		AÇO TEMPER.	AISI 304 A2
CLASSE DE RESISTÊNCIA	4.8		8.8	4.8			8.8	8.8	AISI 304 A2	AISI 316 A4
COMPRIMENTO	1000 mm	3000 mm	1000 mm	1000 mm	2000 mm	3000 mm	1000 mm	1000 mm	1000 mm	1000 mm
M-3	30,07			31,65					140,09	247,97
M-4	42,04			44,25	110,63				140,09	247,97
M-5	55,06			57,96	144,90				123,83	212,01
M-6	60,13	270,59	87,70	63,30	158,24	284,83	93,29		115,90	223,17
M-8	95,44	429,48	132,56	100,46	251,16	452,09	141,02	197,43	200,60	368,24
M-10	148,35	667,59	192,32	156,16	390,40	702,72	204,59	286,43	294,22	546,77
M-12	215,29	968,82	273,03	226,62	566,56	1 019,81	290,46	406,64	427,95	803,40
M-14	304,06	1 368,29	380,10	320,07	800,17	1 440,31	404,36	566,10	615,18	1 227,43
M-16	395,61	1 780,23	468,25	416,43	1 041,07	1 873,93	498,14	697,40	775,66	1 428,28
M-18	498,62	2 243,78	588,67	524,86	1 312,15	2 361,87	626,25	876,74	1 025,29	1 896,93
M-20	628,01	2 826,06	732,71	661,07	1 652,67	2 974,80	779,48	1 091,28	1 221,44	2 343,28
M-22	801,43	3 606,42	965,77	843,61		3 796,24	1 027,41	1 438,38	1 763,29	3 124,37
M-24	917,47	4 128,61	1 093,04	965,76		4 345,90	1 162,81	1 627,93	2 080,29	3 793,87
M-27	1 185,85	5 336,33	1 412,79	1 248,27		5 617,19	1 502,96	2 104,15	3 269,03	5 579,23
M-30	1 453,93	6 542,66	1 732,16	1 530,45		6 887,01	1 842,72	2 579,81	3 962,45	6 695,06
M-33	1 892,10	8 514,45	2 452,83	1 991,69		8 962,58	2 609,40	3 653,15	5 646,49	10 042,60
M-36	2 255,90	10 151,56	2 924,45	2 374,64		10 685,86	3 111,12	4 355,56	6 736,17	11 158,44
M-39	2 839,10		3 450,45	2 988,53			3 670,69	5 138,97	9 906,12	16 737,66
M-42	3 268,06		4 170,37	3 440,06			4 436,56	6 211,19	11 887,34	20 085,19
M-45	3 791,41		5 299,00	3 990,96			5 637,23	7 892,12		
M-48	4 558,81		6 257,46	4 798,74			6 656,88	9 319,63		
M-52	5 702,85		7 392,91	6 003,00			7 864,80	11 010,72		
M-56	6 568,11		8 514,60	6 913,80			9 058,08	12 681,31		
M-60										

CHUMBADOUROS "L" AÇO 4.8 - ZINCADO

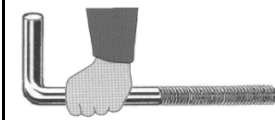

• **ZINCADO**

DIÂMETRO		M-16	M-18	M-20	M-22	M-24	M-27	M-30	M-33	M-36
A(mm)	B(mm)									
200	50	175,05								
250	50	209,21								
	100		327,32							
300	50	243,36								
	100		335,14	426,95		621,21				
350	50	277,52								
	100		377,84							
400	100	347,97	420,54	533,69	657,49	777,02				
500	100	416,28	503,78	550,76	787,70	860,29	1 191,16	1 460,12	1 818,76	2 158,18
600	100	486,71		640,40	920,06	1 005,46	1 389,71	1 701,34	2 121,89	2 516,82
700	100	555,02		732,22	1 050,26	1 148,48	1 588,22	1 944,71	2 425,01	2 875,44
800	100	625,47		824,00	1 182,64	1 291,48	1 786,74	2 188,06	2 728,13	3 236,18
850	150			915,78	1 312,85	1 434,51	1 985,27	2 431,42	3 031,25	3 594,82
1000	250			1 144,20	1 641,58	1 793,15	2 480,53	3 039,80	3 789,08	4 493,53

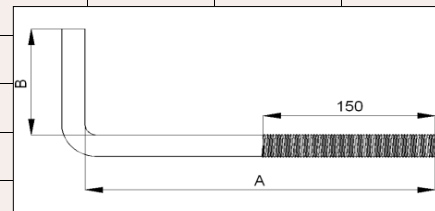

CHUMBADOUROS "L" AÇO 8.8 - ZINCADO

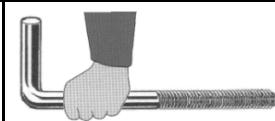

• **ZINCADO**

DIÂMETRO		M-16	M-18	M-20	M-22	M-24	M-27	M-30	M-33	M-36
A(mm)	B(mm)									
200	50	220,21								
250	50	265,37								
	100		372,66							
300	50	308,66								
	100		427,25	542,04		790,48				
350	50	353,83								
	100		479,95							
400	100	440,42	532,63	677,56	833,77	986,22				
500	100	528,87	639,91	813,06	999,40	1 183,83	1 511,33	1 851,97	2 309,33	2 738,45
600	100	617,33		948,58	1 166,89	1 381,46	1 763,51	2 160,63	2 695,15	3 195,78
700	100	705,79		1 084,08	1 332,52	1 579,08	2 015,73	2 469,29	3 079,08	3 651,24
800	100	794,24		1 219,60	1 500,01	1 774,82	2 267,92	2 777,95	3 464,93	4 108,59
850	150			1 355,10	1 665,65	1 972,43	2 520,12	3 086,62	3 848,85	4 564,05
1000	250			1 693,87	2 083,48	2 465,54	3 148,72	3 858,27	4 810,61	5 704,61

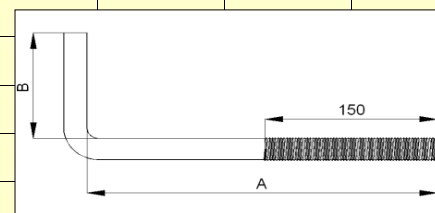

HASTES ROSCADAS DIN 976 (TIPO A)



• AÇO CLASSE 4.8 • ZINCADO

DIÂMETRO COMPRIM. [mm]	M-3	M-4	M-5	M-6	M-8	M-10	M-12
	5	0,70					
6	0,65	0,80	1,05				
8	0,45	0,65	1,00	1,00			
10	0,50	0,55	0,85	1,00	2,99		
12	0,50	0,60	0,90	1,00	3,09		
16	0,55	0,65	0,95	1,00	3,24		
20	0,60	0,75	1,00	1,00	3,47	5,74	9,98
25	0,65	0,80	1,15	1,00	3,69	6,23	10,97
30	0,75	0,90	1,20	1,50	3,94	6,73	12,47
35	0,80	1,00	1,30	1,70	4,14	7,23	13,97
40	0,85	1,10	1,40	1,80	4,39	7,48	14,96
45	0,90	1,25	1,50	1,90	4,64	7,98	16,46
50	1,00	1,40	1,85	2,00	4,99	8,48	17,96
55	1,10	1,55	2,00	2,09	5,24	8,98	19,00
60	1,20	1,65	2,09	2,19	5,49	9,48	20,00
70		1,75	2,24	2,39	5,99	10,47	22,00
80		2,00	2,49	2,79	6,48	11,47	24,00
90			2,99	3,24	6,98	12,47	26,00
100			3,49	3,74	7,48	13,47	28,00
110				4,49	7,98	14,47	30,00
120				4,99	8,48	15,46	32,00
130				5,49	8,98	17,00	34,00
140				5,99	9,48	18,00	36,00
150				6,48	9,98	19,00	38,00

GRAMPOS DIREITOS M-6 PARA COBERTURAS E ACESSÓRIOS



• ALUMÍNIO

HASTE SIMPLES SEM ACESSÓRIOS		ACESSÓRIOS		
COMPRIMENTO (mm)	ALUMÍNIO	ANILHAS CÔNCAVAS - Ø 30 mm		
				
150	34,30	ZINCADO	INOX-A2	BORRACHA
200	42,90	3,20	15,40	3,20
250	48,30	PORCA SEXTAVADA DIN 934 - INOX A2		
300	53,20			
350	57,20	M6	1,62	
400	62,90			
450	68,60			
500	74,30			
600	89,50			

**PARAFUSOS SEXTAVADOS
DIN 558 - 4.8 PRETO**



• PRETO

DIÂMETRO		M-5	M-6	M-8	M-10	M-12	M-16	M-20
COMPRIM. (mm)								
8								
10								
12			1,60					
16			1,55	3,24	6,15			
20			1,78	3,58	6,31	10,11		
25			2,05	3,96	6,96	10,29	23,21	
30			2,28	4,46	7,43	10,73	23,38	
35			2,52	4,85	8,22	11,87	24,17	
40			2,82	5,38	8,84	12,79	26,53	
45			3,08	5,84	9,50	13,87	29,37	
50			3,35	6,29	10,29	14,84	30,34	
55			4,29	6,69	11,21	15,79	33,15	
60			5,01	7,23	11,87	17,04	34,12	
65				8,35	13,58	19,76	37,88	
70				8,74	14,05	20,86	41,69	
80				9,82	15,66	24,62	45,47	
90						28,42	49,28	
100						32,20	53,07	

**PARAFUSOS SEXTAVADOS
DIN 558 - 4.8 ZINCADO**



• ZINCADO

DIÂMETRO		M-5	M-6	M-8	M-10	M-12	M-16	M-20
COMPRIM. (mm)								
8								
10				3,70				
12			1,73	3,40				
16			1,67	3,50	6,42			
20			1,87	3,84	6,72	10,72		
25			2,20	4,26	7,20	10,86	24,76	
30			2,47	4,73	7,95	11,47	24,76	
35			2,73	5,23	8,72	12,54	25,66	
40			3,00	5,70	9,50	13,59	27,51	
45			3,28	6,20	10,09	14,69	30,27	
50			3,61	6,67	11,02	15,89	31,18	
55			4,49	7,15	11,93	16,96	33,94	
60			5,38	7,64	12,54	18,34	35,77	
65			7,00	8,98	14,36	21,09	40,35	
70				9,35	15,15	22,01	43,99	
75					16,84		47,68	
80				10,42	16,84	25,66	47,68	
85					19,35		51,37	
90					19,35	29,35	51,37	
100					23,40	33,03	55,02	
110					31,70		66,30	
120					39,60		73,80	

**PARAFUSOS SEXTAVADOS
DIN 933 - 8.8 PRETO**



• PRETO

DIÂM. COMP. (mm)	M-4	M-5	M-6	M-8	M-10	M-12	M-14	M-16	M-18	M-20	M-22	M-24	M-27	M-30	M-33	M-36
8																
10			1,96	4,35												
12			1,96	3,81												
16			1,94	4,02	7,34											
20			2,16	4,35	7,80	11,30										
25			2,50	4,83	8,30	11,93	23,34	29,85								
30			2,80	5,45	9,11	13,10	21,42	27,21	63,19	63,19						
35			3,18	6,16	9,96	14,24	23,34	29,33	63,19	63,19						
40			3,47	6,65	10,96	15,60	25,14	31,78	59,72	59,72	112,35	112,35				
45			3,79	7,15	11,81	16,61	27,07	34,07	63,19	63,19	110,82	110,82				
50			4,08	7,80	12,46	18,09	28,81	36,18	64,98	64,98	107,66	107,66				
55			4,42	9,79	14,11	19,87	32,82	38,61	68,46	68,46	112,35	112,35				
60			4,83	8,81	14,96	21,41	35,11	41,08	71,98	71,98	117,04	117,04	222,16			
65				10,76	17,09	24,53	40,06	47,24	82,53	82,53	124,85	124,85	240,39			
70			9,96	11,43	18,23	26,03	42,51	49,86	86,01	86,01	131,06	131,06	240,39	301,74		
75				11,93	19,10	27,37	44,10	52,48	89,56	89,56	134,19	134,19	248,67	319,99		
80			11,61	12,61	20,06	28,86	46,37	55,14	93,02	93,02	140,44	140,44	248,67	328,23	994,70	994,70
90			14,87	15,75	24,21	35,00	55,14	71,44	121,11	121,11	165,42	165,42	275,23	354,75	1 074,25	1 074,25
100			18,15	18,59	27,55	39,64	62,50	78,99	133,42	133,42	179,46	179,46	293,44	373,01	1 162,10	1 162,10
110				21,08	43,83	58,69	82,32	110,96	184,33	184,33	226,26	226,26	354,75	452,57	1 241,69	1 241,69
120				22,77	45,36	64,00	89,33	120,24	194,85	194,85	243,43	243,43	373,01	479,15	1 322,95	1 322,95
130					47,30	67,47	113,75	124,15	221,18	221,18	266,82	266,82	417,77	532,17	1 410,84	1 410,84
140					48,33	70,95	122,36	131,49	236,97	236,97	296,44	296,44	470,82	586,90	1 490,36	1 490,36
150					51,31	74,61	131,09	137,32	254,54	254,54	343,28	343,28	532,17	666,42	1 569,96	1 569,96

**PARAFUSOS SEXTAVADOS
DIN 933 - 8.8 ZINCADO**



• ZINCADO

DIÂM. COMP. (mm)	M-4	M-5	M-6	M-8	M-10	M-12	M-14	M-16	M-18	M-20	M-22	M-24	M-27	M-30	M-33	M-36
8	1,15															
10	1,17	1,51	2,09	4,35												
12	1,23	1,41	2,09	3,87												
16	1,41	1,66	1,96	4,04	7,72											
20	1,65	1,94	2,25	4,51	8,06	11,61										
25	1,91	2,22	2,59	4,95	8,54	12,21	24,32	30,75								
30	2,14	2,53	2,92	5,64	9,35	13,47	22,26	28,01		64,57						
35		2,82	3,23	6,15	10,45	14,96	24,32	30,45	64,57	64,57						
40		3,12	3,56	6,71	11,24	16,06	26,22	32,96	61,16	61,16	117,79	117,79				
45		4,02	3,89	7,42	12,06	17,20	27,89	35,34	64,57	64,57	113,26	113,26				
50		4,99	4,25	7,88	13,03	18,61	29,92	37,55	66,27	66,27	110,26	110,26				
55			4,63	10,13	14,42	20,70	34,19	40,11	69,66	69,66	117,79	117,79				
60			5,02	8,98	15,60	21,99	36,21	42,62	73,05	73,05	122,33	122,33	224,60			
65			9,96	11,07	17,83	25,54	41,47	48,92	84,93	84,93	128,34	128,34	240,65			
70			10,30	11,72	18,80	26,82	43,98	51,66	88,31	88,31	134,44	134,44	240,65	309,65		
75			11,71	12,54	19,87	28,42	45,74	54,38	91,73	91,73	140,44	140,44	258,30	327,26		
80			12,03	13,16	20,88	30,02	48,08	57,44	95,16	95,16	146,48	146,48	258,30	335,32	1 029,98	1 029,98
90			15,47	16,24	25,19	36,28	57,44	72,75	124,04	124,04	172,16	172,16	283,98	360,98	1 116,65	1 116,65
100			18,89	19,10	28,58	41,07	64,72	81,89	139,30	139,30	184,23	184,23	301,65	386,67	1 201,68	1 201,68
110				21,74	45,70	60,18	85,47	114,71	191,95	191,95	235,59	235,59	360,98	463,66	1 288,25	1 288,25
120				23,48	47,25	65,33	92,76	123,71	200,46	200,46	250,65	250,65	386,67	489,33	1 373,32	1 373,32
130					49,26	68,71	118,25	127,26	227,65	227,65	274,82	274,82	429,99	550,31	1 459,93	1 459,93
140					50,37	73,96	127,26	136,44	246,33	246,33	308,02	308,02	481,30	601,63	1 544,95	1 544,95
150					53,42	77,34	136,44	141,84	288,08	288,08	356,37	356,37	550,31	686,67	1 631,56	1 631,56

**PARAFUSOS SEXTAVADOS
DIN 933 - 8.8 GALVANIZADO A QUENTE**



• **GALVANIZADO A QUENTE (HDG)**

DIÂM. L (mm)	M-6	M-8	M-10	M-12	M-14	M-16	M-20	M-24	M-27	M-30
16		10,70	17,40							
20		11,87	19,21	28,99						
25		12,47	19,98	29,70						
30		13,92	22,12	32,84		71,90				
35		15,36	24,20	35,96		78,09				
40		16,80	26,25	39,09		78,55	140,95			
45		18,22	28,43	42,24		84,54	143,65			
50		19,58	30,54	45,27		89,68	153,23			
55		21,00	32,65	48,40		95,78	161,95			
60		22,47	34,84	50,68		101,86	170,65	278,40		
65		23,89	36,94	54,68		107,09	180,24	292,15		
70		25,32	39,06	57,82		113,19	188,93	305,89		
75		26,74	41,18	60,95		119,30	197,64	318,71		
80		28,20	43,27	64,07		125,38	207,22	332,45		
90		31,08	47,50	70,36		136,70	224,64	359,91		
100		33,85	51,71	76,63		148,00	242,91	387,39		
110				82,88		160,20	261,20	414,85		
120				95,40		171,51	278,61	442,35		

**PARAFUSOS SEXTAVADOS
DIN 933 - 10.9 - PRETO**



• **PRETO**

DIÂM. L (mm)	M-6	M-8	M-10	M-12	M-14	M-16	M-20	M-24	M-27	M-30	M-33	M-36
16		8,42										
20		9,34	16,12	23,56								
25		9,83	16,77	24,12								
30		10,97	18,55	26,68	44,00	58,44						
35		12,10	20,33	29,22	47,80	63,44						
40		13,24	22,08	31,77	48,05	63,81	114,55	188,89				
45		14,37	23,86	34,32	51,60	68,70	116,75	195,07				
50		15,44	25,61	36,81	55,13	72,88	124,54	197,76				
60		17,69	29,22	41,19	62,12	82,78	138,68	219,41	455,78			
70			32,78	46,98	69,29	92,00	153,54	241,06	495,42	653,96		
80			36,31	52,07	75,73	101,89	168,40	262,00	535,04	693,56	936,76	1149,65
90						111,09	182,56	283,65	594,46	753,01	1000,63	1234,81
100						120,29	197,42	305,29	653,96	852,11	1064,51	1319,98
110						130,20	212,27	326,95	676,60	859,04	1149,65	1405,14
120						139,38	226,43	348,59	800,75	922,42	1213,54	1469,01

**PARAFUSOS SEXTAVADOS
DIN 933 - 10.9 - ZINCADO**



• **ZINCADO**

DIÂM. L (mm)	M-6	M-8	M-10	M-12	M-14	M-16	M-20	M-24	M-27	M-30	M-33	M-36
16		9,88										
20		10,95	18,85	27,57								
25		11,51	19,64	28,24								
30		12,84	21,71	31,20	51,49	68,38						
35		14,16	23,77	34,20	55,93	74,24						
40		15,49	25,85	37,18	56,21	74,67	134,02	220,98				
45		16,82	27,91	40,17	60,37	80,38	136,61	228,23				
50		18,05	29,98	43,05	64,50	85,28	145,71	231,39				
60		20,71	34,20	48,19	72,68	96,86	162,27	256,72	516,94			
70			38,34	54,98	81,07	107,64	179,63	282,04	568,64	740,96		
80			42,47	60,93	88,58	119,37	197,05	306,52	620,36	792,64	1064,51	1319,98
90						129,98	213,59	331,86	672,04	844,35	1149,65	1405,14
100						140,74	230,97	357,20	740,96	947,74	1213,54	1490,31
110						152,33	248,37	382,53	848,90	1114,97	1319,98	1596,76
120						163,09	264,93	407,85	914,80	1153,01	1383,87	1681,92

**PARAFUSOS SEXTAVADOS
DIN 933 INOX-A2**



• INOX-A2

DIÂM. COMP. (mm)	M-4	M-5	M-6	M-8	M-10	M-12	M-14	M-16	M-20	M-24	M-27	M-30
6	2,68											
8	2,57	3,08										
10	2,57	2,72	3,70	9,10								
12	2,68	2,84	3,62	7,79								
16	2,90	3,08	3,62	6,97	14,40	25,81						
20	3,25	3,44	4,07	7,51	14,59	24,39	55,04	64,56				
25	3,61	3,82	4,61	8,35	15,34	23,49	53,00	58,20				
30	4,10	4,35	5,28	9,47	16,33	24,39	49,92	58,20	122,75			
35	4,46	4,72	5,82	10,38	18,33	26,20	51,95	58,20	114,26			
40	5,71	6,03	6,44	11,47	18,89	27,98	55,04	63,47	118,51	249,21		
45	7,08	7,50	6,97	13,03	21,57	31,59	60,10	66,65	122,75	249,21		
50	7,66	8,13	7,51	13,92	22,92	32,52	64,20	69,85	125,93	261,09		
55		7,90	9,46	14,96	24,68	37,03	67,25	76,19	137,57	284,80		
60		8,30	10,07	15,95	27,24	37,03	72,34	80,41	141,80	284,80	605,23	
65			14,48	18,08	29,15	39,72	77,45	87,82	161,90	320,41	628,99	
70			14,48	19,54	31,00	43,36	81,51	90,99	161,90	320,41	652,70	
75			18,28	22,47	32,83	46,05	84,57	100,53	167,19	344,17	676,46	
80			18,28	22,47	34,75	47,85	94,76	107,92	172,48	356,03	700,15	890,04
90			20,28	28,63	44,85	54,16	103,95	116,42	191,51	367,90	759,51	949,36
100			23,99	31,56	49,26	58,70	109,03	123,82	202,08	391,62	795,09	1 008,74
110					53,67	68,63	149,78	162,98	244,42	439,10	937,53	1 210,46
120					58,12	74,08	171,17	174,59	279,34	486,58	984,98	1 269,80
130					82,55	108,36		197,86	302,61	557,77	1 020,59	1 329,13
140					91,70	117,37		209,54	314,24	593,36	1 079,94	1 388,47
150					100,88	126,42		221,13	349,18	617,11	1 139,25	1 447,81

**PARAFUSOS SEXTAVADOS
DIN 933 INOX-A4**



• INOX-A4

DIÂM. COMP. (mm)	M-4	M-5	M-6	M-8	M-10	M-12	M-14	M-16	M-20	M-24	M-27	M-30
6	5,48											
8	5,24	6,62										
10	5,24	5,83	7,65	17,06								
12	5,48	6,12	7,81	15,49								
16	5,94	6,62	8,20	15,56	32,12							
20	6,64	7,38	9,17	17,06	32,67	52,41	100,79					
25	7,31	8,15	10,05	19,10	34,36	54,10	100,21	123,12				
30	8,40	9,35	11,67	21,54	37,84	56,21	106,08	133,79	256,28			
35	9,11	10,16	12,72	23,72	42,23	60,91	111,67	141,48	260,55			
40	10,12	11,25	14,05	25,52	43,58	65,07	121,53	150,63	277,68	487,12		
45	14,46	16,10	15,67	27,98	48,36	71,39	130,49	161,85	295,49	511,48		
50	15,72	17,46	19,26	30,07	51,50	74,51	138,16	170,24	309,45	536,86		
55		18,65	21,46	32,60	56,14	79,97	145,31	179,43	337,91	561,56		
60		19,59	22,69	34,86	60,08	84,53	154,56	189,82	350,74	584,70		
65			24,56	38,36	63,26	92,86	162,88	202,14	364,50	604,21		
70			26,42	41,78	65,86	98,84	171,46	211,63	378,07	628,93		
75			29,76	43,79	70,43	102,92	181,29	226,76	392,88	662,51		
80			32,92	46,02	73,76	106,72	189,24	240,59	409,90	694,48		
90				52,13	85,70	118,84	231,09	241,42	468,67	763,93		
100				59,44	104,75	138,65	264,11	275,11	513,67	822,33		
110					133,32	173,33	374,11	385,16	633,28	1 055,52		
120					161,88	217,88	429,15	440,16	738,87	1 213,84		
130												
140												
150												

PARAFUSOS SEXTAVADOS DIN 931 - 8.8 PRETO



DESCIDA
DE
PREÇO

• **PRETO**

DIÂMETRO	M-6	M-8	M-10	M-12	M-14	M-16	M-18	M-20	M-22
COMPRIMENTO (mm)									
30	3,71	8,93							
35	3,99	7,66	12,78						
40	4,47	8,45	14,35	18,36					
45	4,95	9,27	15,47	21,68					
50	5,44	9,86	16,61	21,68	35,91	44,91			
55	5,76	10,65	17,87	23,28	35,91	44,91			
60	6,25	10,65	17,53	23,12	38,60	48,22	86,46	108,08	
65	6,70	11,34	19,14	24,53	41,25	51,53	73,15	91,45	
70	7,17	12,15	19,76	25,64	41,25	51,53	66,50	83,12	102,77
75	7,66	12,78	21,07	27,45	42,57	53,20	69,19	86,48	108,74
80	8,74	14,19	22,17	28,83	45,21	56,52	73,15	91,45	108,74
90	10,55	15,95	24,38	31,90	49,21	61,50	79,79	99,73	118,29
100	11,62	18,66	26,63	35,22	53,18	66,48	86,46	108,08	127,84
110	20,41	21,68	31,08	40,15	58,53	73,15	93,12	116,39	138,61
120	23,28	22,97	33,48	43,52	62,52	78,14	99,76	124,69	146,96
130		28,69	38,45	50,20	66,50	83,12	103,75	129,69	166,05
140		32,20	42,86	56,92	70,52	88,12	109,03	136,31	175,63
150		36,35	47,80	63,56	74,46	93,10	119,67	149,62	186,39
160			100,39	100,39	126,32	157,91	210,14	262,68	264,05
170			115,48	150,54	139,66	174,56	223,41	279,26	326,19
180			128,87	167,26	139,66	174,56	223,41	279,26	326,19
200			180,65	200,74	154,28	192,85	251,35	314,20	376,36
220				234,16	335,13	418,91	517,29	646,63	590,19
240				301,08	363,06	453,82	586,48	733,09	652,34
260				368,00	433,53	541,92	656,94	821,15	752,70
280				434,90	489,36	611,73	726,07	907,61	866,18
300				518,54	545,21	681,51	796,57	995,71	966,57
320					601,07	751,35	837,78	1 047,24	1 078,85
340					670,22	837,79	908,27	1 135,34	1 192,35
360					726,07	907,61	964,13	1 205,18	1 292,73
380					796,57	995,71	1 033,25	1 291,58	1 405,03
400					837,78	1 047,24	1 075,82	1 344,75	1 505,39

DIÂMETRO	M-24	M-27	M-30	M-33	M-36	M-39	M-42	M-45	M-48
COMPRIMENTO (mm)									
30									
35									
40									
45									
50									
55									
60									
65									
70	137,01	299,85							
75	145,00	299,85							
80	145,00	299,85	503,77						
90	157,70	268,39	394,35						
100	170,46	299,85	425,81	870,44	1 024,05				
110	184,79	299,85	457,30	870,44	1 024,05				
120	195,94	331,35	503,77	870,44	1 024,05	1 325,36	1 559,25	2 476,15	2 913,13
130	221,43	331,35	520,24	923,93	1 086,98	1 445,15	1 700,20	2 583,21	3 039,04
140	234,16	362,86	551,74	990,19	1 164,96	1 552,21	1 826,13	2 636,71	3 102,02
150	248,52	377,85	583,23	1 016,97	1 196,44	1 605,73	1 889,10	2 863,54	3 368,87
160	352,06	598,23	772,16	1 031,01	1 212,96	1 726,81	2 031,53	3 318,51	3 904,12
170	434,90	692,67	898,08	1 097,24	1 290,86	1 780,34	2 094,53	3 600,16	4 235,48
180	434,90	692,67	898,08	1 150,78	1 353,86	1 780,34	2 094,53	4 014,31	4 722,74
200	501,80	803,62	976,05	1 245,09	1 464,80	1 833,83	2 157,44	4 295,97	5 054,09
220	786,95	1 024,05	1 133,47	1 378,90	1 622,25	2 021,18	2 377,86	4 576,31	5 383,91
240	869,81	1 212,96	1 353,86	1 525,44	1 794,63	2 181,75	2 566,77	4 924,22	5 793,22
260	1 003,59	1 290,86	1 496,30	1 578,99	1 857,65	2 288,81	2 692,72	5 272,15	6 202,52
280	1 154,92	1 496,30	1 700,20	1 726,81	2 031,53	2 583,21	3 039,04	5 593,30	6 580,34
300	1 288,77	1 622,25	1 889,10	2 181,75	2 566,77	2 863,54	3 368,87	6 008,74	7 069,10
320	1 438,48	1 826,13	2 094,53	2 408,60	2 833,64	3 145,19	3 700,23	6 289,11	7 398,96
340	1 589,82	2 031,53	2 298,44	2 636,71	3 102,02	3 439,57	4 046,55	6 583,47	7 745,26
360	1 723,64	2 235,42	2 503,79	2 863,54	3 368,87	3 719,95	4 376,40	6 865,11	8 076,60
380	1 873,40	2 424,35	2 692,72	3 091,63	3 637,24	4 014,31	4 722,74	7 427,14	8 737,82
400	2 007,17	2 644,76	2 913,13	3 318,51	3 904,12	4 295,97	5 054,09	8 001,89	9 414,01

PARAFUSOS SEXTAVADOS DIN 931 - 8.8 ZINCADO



• ZINCADO

DIÂMETRO	M-6	M-8	M-10	M-12	M-14	M-16	M-18	M-20	M-22
30	3,79	9,18							
35	4,12	7,88	13,09						
40	4,61	8,71	14,85	18,89					
45	5,05	9,47	15,95	22,37					
50	5,55	10,41	17,34	22,37	34,55	46,08			
55	5,84	11,04	18,43	24,28	34,55	46,08			
60	6,29	11,04	18,15	24,13	37,01	49,34	89,50	111,88	
65	7,08	11,67	19,85	25,42	39,48	52,63	74,98	93,73	
70	7,44	12,47	20,67	26,82	39,48	52,63	68,43	85,54	127,65
75	7,88	13,24	21,76	28,40	40,69	54,29	71,06	88,80	134,76
80	8,97	14,70	22,86	30,13	43,16	57,55	74,98	93,73	134,76
90	10,88	16,42	25,22	33,11	46,86	62,51	81,57	101,95	146,11
100	11,99	19,24	27,75	36,41	50,56	67,43	89,50	111,88	158,84
110	21,14	22,37	32,19	41,45	56,75	75,67	96,03	120,04	171,62
120	24,28	23,96	34,82	44,75	60,46	80,60	102,63	128,30	184,40
130		29,63	40,08	51,39	64,16	85,54	106,56	133,20	205,69
140		33,59	44,61	57,99	67,84	90,46	114,47	143,10	219,84
150		37,85	49,48	64,62	71,54	95,37	123,68	154,61	231,19
160			104,32	99,32	117,15	156,22	207,86	259,82	327,63
170			119,15	148,96	129,51	172,66	221,02	276,27	402,81
180			134,12	165,48	129,51	172,66	221,02	276,27	402,81
200			187,11	198,56	143,10	190,78	248,67	310,81	462,37
220				231,66	324,39	432,50	524,88	656,09	730,44
240				297,85	350,28	467,02	607,76	759,71	804,15
260				380,59	414,39	552,53	677,48	846,87	938,92
280				446,77	466,20	621,61	745,92	932,39	1 072,21
300				529,50	531,56	708,73	815,64	1 019,52	1 206,97
320					583,33	777,77	870,85	1 088,57	1 340,28
340					647,47	863,29	939,28	1 174,12	1 475,00
360					699,27	932,39	994,51	1 243,16	1 608,31
380					764,66	1 019,52	1 064,25	1 330,30	1 743,06
400					816,43	1 088,57	1 119,47	1 399,35	1 876,38

DIÂMETRO	M-24	M-27	M-30	M-33	M-36	M-39	M-42	M-45	M-48
30									
35									
40									
45									
50									
55									
60									
65									
70	141,83	311,47							
75	149,75	311,47							
80	149,75	311,47	514,67						
90	162,36	265,50	404,94						
100	176,48	296,67	436,06	847,19	1 058,99				
110	190,67	311,47	467,21	847,19	1 058,99				
120	204,86	342,61	514,67	847,19	1 058,99	1 295,70	1 619,65	2 568,02	3 021,18
130	228,53	342,61	529,51	897,03	1 121,27	1 408,41	1 760,52	2 687,80	3 162,10
140	244,26	373,78	560,67	959,90	1 199,90	1 519,95	1 899,93	2 740,73	3 224,41
150	256,90	390,11	591,82	984,83	1 231,02	1 569,79	1 962,23	2 978,99	3 504,71
160	364,04	622,92	794,99	1 009,75	1 262,19	1 682,51	2 103,13	3 455,54	4 065,34
170	447,59	716,35	919,56	1 071,47	1 339,32	1 744,20	2 180,25	3 746,75	4 407,97
180	447,59	716,35	919,56	1 121,27	1 401,60	1 744,20	2 180,25	4 170,33	4 906,31
200	513,74	826,11	1 013,02	1 209,06	1 511,34	1 794,01	2 242,54	4 461,61	5 248,94
220	811,58	1 058,99	1 168,74	1 345,52	1 681,89	1 968,45	2 460,58	4 765,38	5 606,33
240	893,52	1 262,19	1 401,60	1 483,18	1 853,97	2 130,98	2 663,74	5 123,44	6 027,56
260	1 043,23	1 339,32	1 542,48	1 544,86	1 931,09	2 242,54	2 803,17	5 480,19	6 447,28
280	1 191,35	1 542,48	1 760,52	1 682,51	2 103,13	2 529,67	3 162,10	5 824,36	6 852,18
300	1 341,08	1 681,89	1 962,23	2 130,98	2 663,74	2 803,78	3 504,71	6 247,96	7 350,53
320	1 489,21	1 899,93	2 180,25	2 355,27	2 944,08	3 077,84	3 847,29	6 539,17	7 693,14
340	1 638,89	2 103,13	2 383,44	2 579,53	3 224,41	3 363,80	4 204,74	6 844,27	8 052,08
360	1 787,01	2 321,12	2 601,47	2 803,78	3 504,71	3 637,91	4 547,38	7 135,44	8 394,68
380	1 936,71	2 522,88	2 803,17	3 028,05	3 785,05	3 925,05	4 906,31	7 730,53	9 094,72
400	2 084,87	2 740,87	3 021,18	3 252,27	4 065,34	4 199,14	5 248,94	8 326,79	9 796,21

**PARAFUSOS SEXTAVADOS
DIN 931 - 10.9 PRETO**



• **PRETO**

DIÂM.	M-6	M-8	M-10	M-12	M-14	M-16	M-20	M-24	M-27	M-30	M-33	M-36
COMP. (mm)												
30												
35		10,00										
40		11,13	18,19									
45		11,76	19,58	27,40								
50		12,55	20,70	29,16	48,59	58,74						
55		13,47	21,62	31,01	50,13	61,09						
60		14,08	23,04	32,74	53,25	64,24	108,08					
70		16,28	26,62	37,43	59,53	70,48	117,50	211,45				
80		20,36	31,50	44,17	65,79	78,33	128,45	211,45	438,60	563,92		
90		23,04	34,78	48,87	72,07	86,15	139,42	227,15	469,97	610,94		
100		26,78	38,86	54,52	79,90	95,58	155,10	245,96	485,62	626,59	822,57	1 016,12
110		29,01	45,60	62,07	86,15	103,41	167,62	269,43	532,63	673,60	887,09	1 080,63
120		35,09	49,35	67,07	97,14	115,92	186,41	303,90	563,92	720,59	951,60	1 145,15
130			54,22	73,64	104,96	125,32	203,64	327,40	595,27	751,90	999,99	1 209,66
140			61,57	82,71	115,92	137,85	222,45	355,58	626,59	798,91	1 064,51	1 290,30
150			68,17	91,49	122,20	145,66	234,97	375,96	673,60	861,59	1 112,88	1 354,82
160												

**PARAFUSOS SEXTAVADOS
DIN 931 - 10.9 ZINCADO**



• **ZINCADO**

DIÂM.	M-6	M-8	M-10	M-12	M-14	M-16	M-20	M-24	M-27	M-30	M-33	M-36
COMP. (mm)												
30												
35		14,26										
40		15,35	24,74									
45		16,46	26,78	37,75								
50		17,55	28,52	40,28	61,09	78,33						
55		18,81	30,09	43,09	64,24	83,03						
60		20,05	31,96	45,60	67,36	87,75	147,25					
70		23,04	36,82	52,00	76,76	98,69	161,36	278,86				
80		27,90	42,75	60,48	84,57	108,08	177,03	286,67	563,92	736,27		
90		31,50	47,18	66,90	92,40	119,07	194,24	305,48	610,94	783,25		
100		36,06	52,48	74,40	103,41	131,58	214,62	333,65	642,25	798,91	935,48	1161,27
110		39,17	60,63	83,49	111,23	142,55	231,85	365,01	689,30	861,59	1016,12	1241,91
120		46,06	65,48	90,25	123,76	158,24	253,77	405,74	736,27	924,23	1096,76	1306,42
130			73,93	101,99	137,85	178,59	288,24	452,71	767,59	971,24	1161,27	1387,08
140			82,71	113,10	150,38	192,69	311,75	487,20	814,58	1033,88	1225,79	1483,85
150			90,69	123,91	159,78	205,22	330,53	516,94	877,24	1112,21	1274,18	1548,36
160												

**PARAFUSOS SEXTAVADOS
DIN 931 - INOX-A2**



• **INOX-A2**

DIÂM. COMP. (mm)	M-5	M-6	M-8	M-10	M-12	M-14	M-16	M-20	M-24	M-30
40		8,12	14,75	24,12	34,42					
45		8,98	16,08	26,48	36,32					
50		9,66	16,74	27,69	38,39	66,18	80,51			
55		10,97	18,81	30,46	41,98	68,08	80,51			
60		11,72	19,48	32,52	44,16	71,86	83,47	160,03		
65		14,00	22,13	34,23	46,73	78,49	92,29	154,16		
70		14,75	23,92	36,32	49,94	81,31	94,27	160,03	341,45	
75		19,29	26,29	39,04	52,77	86,06	102,13	172,81	341,45	
80		20,71	29,12	41,61	58,62	90,77	107,03	179,67	310,21	
90		25,26	34,14	45,11	66,18	98,33	123,71	197,36	341,45	
100		26,48	36,23	55,02	71,86	110,62	132,55	216,98	364,28	
110		30,25	50,10	59,57	80,35	119,14	142,37	230,74	396,04	
120		34,03	53,91	64,31	86,06	129,54	153,16	251,35	423,34	
130			63,35	83,21	95,49	148,45	162,00	266,08	446,42	
140			68,08	95,49	102,13	157,92	176,71	280,78	476,89	
150			73,74	102,13	109,67	168,30	189,49	319,10	510,04	
160					165,48	329,04	225,84	361,33	551,61	
180					185,30	478,40	253,33	439,85	723,54	
200					250,55	497,31	280,78	518,40	834,36	
220							481,10	724,57	1 080,02	
240							534,11	810,02	1 404,00	
260							553,74	872,83	1 462,91	
280							641,14	935,67	1 580,73	
300							665,70	976,92	1 649,45	

**PARAFUSOS SEXTAVADOS
DIN 931 - INOX-A4**



• **INOX-A4**

DIÂM. COMP. (mm)	M-5	M-6	M-8	M-10	M-12	M-14	M-16	M-20	M-24	M-30
40		13,78	25,29	43,29	64,40					
45		15,42	27,62	48,07	69,69					
50		19,08	29,36	51,57	74,10	116,56	147,45			
55		21,50	32,42	56,38	79,91	124,42	147,88			
60		23,09	34,53	60,39	85,34	131,17	157,15	288,47		
65		24,90	39,87	64,29	92,64	137,76	168,86	279,69		
70		26,53	42,28	68,27	98,20	147,67	190,54	296,31	664,22	
75		28,49	45,81	71,88	105,93	158,81	193,55	326,19	664,22	
80		30,06	47,82	76,51	111,24	167,18	204,62	326,19	580,14	
90		33,83	53,84	85,48	124,06	183,55	226,05	361,28	638,59	
100		37,45	57,68	94,78	136,68	203,13	246,22	394,72	681,32	
110		41,57	63,15	103,68	148,56	222,31	269,56	431,23	740,67	
120		47,16	69,57	114,48	162,25	242,54	290,74	471,67	792,73	
130			100,69	128,83	178,64	284,72	308,77	505,26	834,97	
140			109,34	152,64	190,54	302,05	331,83	543,13	891,92	
150			117,99	162,40	204,62	321,54	356,90	575,31	953,89	
160					263,09	524,00	408,87	662,65	1 027,93	
180					294,47	762,16	557,41	871,93	1 283,97	
200					399,49	792,49	634,22	955,35	1 494,22	
220							741,58	1 122,68		
240							823,88	1 254,76		
260							853,11	1 352,19		
280							988,43	1 449,64		
300							1 026,33	1 514,59		

PARAFUSOS TIREFONDS DIN 571 - NORMALIZADOS



• AÇO ZINCADO • INOX-A2

DIÂMETRO COMPRIMENTO (mm)	M-6		M-7		M-8		M-10	
	ZINCADO	INOX-A2	ZINCADO	INOX-A2	ZINCADO	INOX-A2	ZINCADO	INOX-A2
25	2,75							
30	2,94	7,76	5,20		6,18			
35	3,29	8,69	5,34		6,37			
40	3,40	8,99	5,46		6,53			
45	3,65	9,68	5,73		6,89			
50	3,97	10,42	5,93		7,35	20,16	13,32	
60	4,70	12,38	6,78		8,43	23,09	15,30	
65	4,97							
70	5,21	13,76	7,70		9,56	26,25	17,45	
75	5,72							
80	6,26	16,52	8,72		10,79	29,60	19,58	
90			10,07		12,73	34,91	20,57	
100			11,14		13,98	38,33	24,17	
110			11,95		15,03	41,30	25,29	
120			12,54		16,12	44,27	28,49	
130			13,45		18,66	48,13	31,91	
140			14,60		19,80	53,06	35,30	
150			15,27		21,01	56,34	38,74	
160					22,17		42,56	
170					23,33		44,70	
180					27,76		46,83	
190					29,19		49,37	
200					30,49		51,85	

PARAFUSOS CABEÇA OVAL E QUADRA DIN 603 - 4.8 - ZINCADO E INOX-A2



• 4.8 ZINCADO • INOX-A2

DIÂM. COMP. (mm)	M-5		M-6		M-8		M-10		M-12		M-16	
	ZINCADO	INOX-A2	ZINCADO	INOX-A2	ZINCADO	INOX-A2	ZINCADO	INOX-A2	ZINCADO	INOX-A2	ZINCADO	INOX-A2
12	2,57		3,43									
16	2,57		3,43	7,36								
20	2,88		3,48	7,70	6,49	14,73	11,52	24,23				
25	3,26		3,89	8,62	7,19	16,43	12,75	26,90				
30	3,74		4,38	9,48	8,00	18,14	14,04	29,57	32,81	51,22		
35	4,25		4,91	10,57	8,89	19,27	15,29	32,24	32,89	55,37		
40	4,81		5,40	11,65	9,83	21,29	16,60	34,90	32,89	59,51		
45	5,26		5,92	12,74	10,75	23,32	18,32	38,21	33,42	63,66		
50	5,75		6,42	13,82	11,24	25,35	19,69	41,52	33,65	68,59		
55	6,63		6,91	14,90	12,07	27,38	20,25	44,83	35,99	73,52		
60	7,15		7,43	15,99	12,97	29,30	21,99	48,14	38,53	78,45	140,54	
65			8,89		15,10		25,04					
70			8,89	18,16	15,10	33,36	25,04	54,76	43,40	88,32	150,17	
75			9,96		16,19							
80			9,96	20,34	16,19	37,31	26,92	61,37	47,80	97,51	159,75	
90			11,02	22,51	17,95	41,37	31,63	67,99	55,59	107,59	169,43	
100			12,07	24,69	19,66	45,42	34,63	74,61	60,96	117,68	179,05	
110					24,78		41,61	81,23	73,08	127,76	191,55	
120					26,90		44,96	87,84	78,80	137,85	219,47	
130					31,17		48,33	94,46	84,52	147,93	223,30	
140					33,15		51,96	101,40	90,21	158,02	229,10	
150					35,40		55,02	107,80	95,89	168,11	238,73	
160							63,21		101,61		257,95	
180							70,40		113,40		288,77	
200							77,32		124,77		308,08	

**PARAFUSOS CABEÇA CILÍNDRICA
COM SEXTAVADO INTERIOR
DIN 912 - 8.8 - PRETO**



• **PRETO**

Ø	M-4	M-5	M-6	M-8	M-10	M-12	M-14	M-16	M-20
L[mm]									
6	2,31								
8	2,35	2,60	2,88						
10	2,46	2,65	2,88	6,35					
12	2,47	2,70	2,93	6,35					
16	2,51	3,08	3,35	6,45	11,13				
20	2,77	3,36	3,78	7,11	12,06	19,01			
25	3,27	3,57	4,27	7,85	13,41	19,50	37,88	43,24	
30	3,61	3,65	4,85	8,81	14,70	21,53	39,11	44,65	
35	4,88	4,68	5,44	9,65	16,05	23,79	42,50	47,99	95,75
40	5,42	5,43	6,05	10,82	17,89	25,44	45,53	52,20	98,79
45		5,98	6,81	11,94	19,81	27,91	49,43	54,76	106,79
50		6,53	7,91	12,97	21,19	30,00	51,69	59,54	112,26
55			9,67	14,12	23,26	32,57	56,09	63,19	118,44
60			10,28	15,24	24,64	36,60	59,97	67,84	126,01
65			11,28	17,41	26,63	37,70	65,29	72,61	135,67
70			12,17	21,19	27,83	39,59	70,20	77,22	139,58
80			14,41	23,72	33,70	45,93	80,98	85,32	156,70
90			16,42	26,21	40,39	55,27	87,57	92,97	173,25
100			18,25	29,08	44,55	60,63	94,96	118,05	184,06
110			21,75	42,94	48,68	69,45	111,12	127,11	210,98
120			27,31	48,40	52,43	73,09	119,84	135,82	225,79
130			48,36	60,24	60,69	85,94	139,60	158,02	261,31
140			51,82	61,24	64,92	93,41	148,88	169,10	277,50
150			58,75	68,37	68,37	98,50	158,67	179,20	294,49
160				117,74	141,31	147,64	190,66	196,64	325,47
180				129,40	159,91	162,87	213,05	218,32	382,71
200				143,41	175,93	191,45	234,16	239,84	416,23

**PARAFUSOS CABEÇA CILÍNDRICA
COM SEXTAVADO INTERIOR
DIN 912 - 8.8 - ZINCADO**



• **ZINCADO**

Ø	M-4	M-5	M-6	M-8	M-10	M-12	M-14	M-16	M-20
L[mm]									
6	2,49								
8	2,54	2,81	3,08						
10	2,66	2,85	3,08	6,93					
12	2,66	2,93	3,18	6,93					
16	2,70	3,32	3,62	6,99	12,08				
20	3,00	3,63	4,11	7,70	13,07	20,83			
25	3,52	3,85	4,64	8,51	14,54	21,14	40,92	46,71	
30	3,91	3,94	5,27	9,54	15,94	23,35	42,25	48,25	
35	5,27	5,05	5,92	10,48	17,40	25,80	45,93	51,84	103,03
40	5,84	5,87	6,58	11,73	19,39	27,58	49,18	56,39	106,32
45		6,46	7,39	12,94	21,47	30,26	53,39	59,16	114,91
50		7,05	8,60	14,05	22,98	32,53	55,84	64,32	120,81
55			10,52	15,31	25,21	35,31	60,59	68,27	127,45
60			11,19	16,52	26,71	39,69	64,78	73,28	135,60
65			12,29	18,88	28,86	40,87	70,53	78,44	145,99
70			13,23	22,97	30,16	42,92	75,83	83,44	150,21
80			15,69	25,72	36,53	49,80	87,49	92,16	168,61
90			17,85	28,40	43,78	59,91	94,61	100,43	186,43
100			19,84	31,52	48,29	65,74	102,58	127,52	198,07
110			23,65	46,54	52,76	75,28	120,03	137,32	227,05
120			29,69	52,48	56,84	79,23	129,46	146,72	242,97
130			52,59	65,30	65,79	93,16	150,81	170,71	281,22
140			56,35	66,40	70,37	101,27	160,84	182,67	298,61
150			63,90	74,11	72,93	106,79	171,40	193,60	316,90
160				127,63	153,19	160,05	205,96	212,42	350,23
180				140,26	173,36	176,56	230,16	235,84	411,83
200				155,47	190,73	207,55	252,97	259,09	447,92

**PARAFUSOS CABEÇA CILÍNDRICA
COM SEXTAVADO INTERIOR
DIN 912 - 12.9**



• **PRETO**

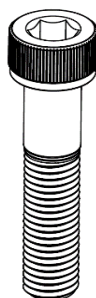

YFS®

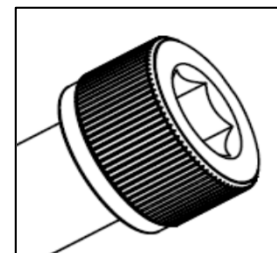

DIÂMETRO	M-4	M-5	M-6	M-8	M-10	M-12	M-14	M-16	M-20	M-24	M-30
8	2,80	3,10									
10	2,94	3,15	4,51								
12	2,95	3,23	4,19	9,96							
16	2,98	3,67	3,56	7,26	12,55	26,95					
20	3,32	4,00	4,02	8,00	13,57	24,06					
25	3,88	4,26	4,56	8,85	15,10	21,96					
30	4,31	4,36	5,17	9,90	16,57	24,26	44,94	49,93			
35	5,81	5,58	5,80	10,88	18,08	26,79	48,28	53,65			
40	6,45	6,47	6,45	12,18	20,15	28,65	52,52	58,35	109,53		
45	7,20	7,14	7,26	13,44	22,31	31,44	55,10	61,23	118,39		
50	9,94	7,79	8,43	14,59	23,89	33,80	59,91	66,57	124,47	263,32	
55		9,59	10,32	15,91	26,20	36,69	63,59	70,65	131,31	277,28	
60		10,42	10,98	17,16	27,74	41,23	68,26	75,85	139,71	281,89	644,67
65		11,69	12,05	19,61	29,99	42,46	73,06	81,18	150,42	307,27	733,59
70		13,20	12,99	23,87	31,33	44,59	77,70	86,33	154,75	307,27	733,59
80			15,39	26,71	37,96	51,74	85,84	95,38	173,71	334,79	778,05
90			17,52	29,51	45,48	62,24	93,53	103,93	192,07	355,00	822,51
100			19,47	32,76	50,17	68,28	118,77	131,98	204,07	385,35	866,97
110			23,21	48,37	54,82	78,23	127,91	142,12	233,93	425,35	911,43
120			29,13	54,53	59,04	82,33	136,65	151,84	250,33	455,55	955,89
130			51,60	67,85	68,35	96,80	159,01	176,67	289,73	490,16	1 000,35
140			55,28	68,99	73,11	105,22	170,14	189,04	307,65	562,86	1 044,81
150			62,70	77,00	75,78	110,94	180,32	200,35	326,50	595,75	1 089,27
160				132,61	159,16	166,29	283,32	314,81	534,22	679,31	1 222,65
180				145,73	180,12	183,44	309,09	343,43	587,64	792,53	1 333,80
200				161,53	198,15	215,63	334,84	372,05	641,05	849,13	1 444,95
220						321,30	412,11	457,90	747,91	1 132,17	1 778,40
240						351,90	463,62	515,13	854,74	1 415,21	2 000,70
260						382,50	515,13	572,37	961,59	1 698,26	2 111,85
280						428,40	566,65	629,61	1 068,43	1 981,30	2 334,15
300						497,25	618,16	686,85	1 175,27	2 264,35	2 556,45

**PARAFUSOS CABEÇA CILÍNDRICA
COM SEXTAVADO INTERIOR
DIN 912 - INOX-A2**



**DESCIDA
DE
PREÇO**

• **INOX-A2**

DIÂM. COMP. (mm)	M-4	M-5	M-6	M-8	M-10	M-12	M-14	M-16	M-20	M-24
8	3,23	5,34								
10	3,47	4,02	6,09	13,98						
12	2,43	3,31	4,44	10,08	35,29					
16	2,65	3,65	4,48	8,88	22,53	47,44				
20	2,74	3,89	5,20	10,16	17,55	28,35	92,36	92,36		
25	3,23	4,86	5,63	11,25	19,32	27,41	87,18	87,18		
30	3,69	5,44	6,31	12,13	20,98	29,78	78,88	78,88	197,17	
35	5,10	6,30	7,60	15,06	22,84	32,47	83,00	83,00	209,64	
40	5,59	6,93	8,29	15,44	23,88	35,48	87,18	87,18	221,03	
45		8,31	9,64	18,02	27,08	37,36	92,36	92,36	235,57	
50		9,93	10,91	19,46	30,00	40,38	97,55	97,55	234,52	
55		15,25	12,74	20,79	34,37	45,36	103,77	103,77	241,78	
60		16,04	13,77	22,05	37,06	49,19	109,99	109,99	254,24	
65			17,93	25,19	41,11	55,40	122,46	122,46	277,06	
70			17,93	25,19	41,11	55,40	122,46	122,46	277,06	
80			23,67	30,42	48,90	65,91	131,78	131,78	300,93	
90			28,10	41,91	58,33	72,55	147,36	147,36	326,88	
100			32,40	46,17	68,89	81,68	163,97	163,97	364,23	
110				66,00	98,57	125,57	216,87	216,87	455,55	
120				73,99	107,92	139,04	237,63	237,63	497,05	
130					126,60	167,08	280,19	280,19	539,61	
140					136,98	184,71	303,00	303,00	583,19	
150					148,39	203,38	326,88	326,88	626,76	

**PARAFUSOS CABEÇA CILÍNDRICA
COM SEXTAVADO INTERIOR
DIN 912 - INOX-A4**



**DESCIDA
DE
PREÇO**

• **INOX-A4**

DIÂM. COMP. (mm)	M-4	M-5	M-6	M-8	M-10	M-12	M-14	M-16	M-20	M-24
8	6,50									
10	5,70	6,50	11,61							
12	6,11	6,98	10,56	21,12						
16	6,98	7,16	11,09	20,07	43,29					
20	7,16	7,31	11,61	22,16	38,01	59,10				
25	7,31	8,92	12,66	24,29	40,11	57,00		152,03		
30	8,15	10,56	14,80	27,44	43,29	61,24		155,17		
35	9,76	11,37	17,96	34,86	47,50	67,55		162,58		
40	10,56	13,01	20,07	36,95	50,68	73,89		179,44	519,69	
45	13,01	15,44	21,12	40,11	59,10	77,06		195,31		
50	14,61	17,06	24,29	43,29	63,35	83,39		200,57	548,93	
55		18,68	28,49	47,50	68,63	93,93		220,64		
60		24,43	30,62	50,68	73,89	101,34		233,30	596,84	
70			36,95	62,29	90,79	125,60		273,42		
80				79,18	110,84	145,67		321,97		
90				89,74	136,19	173,14		370,53		
100				101,34	157,29	195,31		445,46		
110										
120										
130										
140										
150										

**PARAFUSOS CABEÇA CHATA
COM SEXTAVADO INTERIOR
DIN 7991 - 10.9 - PRETO**



• PRETO

DIÂM. COMP. (mm)	M-3	M-4	M-5	M-6	M-8	M-10	M-12	M-14	M-16	M-20
8	2,72	2,95	2,47							
10	2,60	2,38	2,47	3,71						
12	2,72	2,47	2,57	3,55	5,99					
16	2,84	2,57	2,61	3,29	5,99	14,42				
20	3,15	2,70	2,85	3,45	6,15	11,74	24,38			
25	3,41	2,98	3,08	3,71	6,46	12,26	24,53			
30	3,66	3,54	3,77	4,32	7,14	12,64	24,71	44,24	49,15	
35		4,05	4,47	5,15	7,91	13,89	25,13	46,52	51,69	
40		4,80	5,36	5,91	8,91	15,24	25,72	48,66	54,06	147,17
45		8,11	6,87	7,20	9,90	16,64	27,37	51,96	57,73	152,69
50		9,30	8,86	8,79	10,83	18,86	29,20	55,31	61,46	158,23
55				11,41	13,85	21,38	32,45	59,73	66,36	163,69
60				14,04	16,82	26,81	36,46	64,19	71,33	172,57
65				19,28	20,43	32,05	40,10	92,90	103,22	187,02
70				19,28	20,43	32,05	40,10	92,90	103,22	187,02
80				21,57	26,67	43,34	54,69	124,54	138,38	221,22
90				24,39	41,77	56,00	101,01	149,26	149,26	298,53
100				27,21	51,83	71,05	101,01	170,59	170,59	341,18
110				50,33	78,17	126,61	152,36	188,96	188,96	377,06
120				57,83	91,63	137,78	174,23	213,24	213,24	426,47
130							186,30		236,84	445,46
140							202,50		260,78	479,66
150							218,70		284,72	507,02

**PARAFUSOS CABEÇA CHATA
COM SEXTAVADO INTERIOR
DIN 7991 - 10.9 - ZINCADO**



• ZINCADO

DIÂM. COMP. (mm)	M-3	M-4	M-5	M-6	M-8	M-10	M-12	M-14	M-16	M-20
8	2,99	3,10	2,85							
10	2,87	2,61	2,85	4,21						
12	2,99	2,70	2,98	4,11	7,06					
16	3,10	2,85	3,17	4,01	7,06	15,60				
20	3,46	3,08	3,49	4,26	7,45	13,74	28,23			
25	3,79	3,41	3,77	4,68	8,10	14,60	29,13			
30	4,06	4,10	4,62	5,50	8,98	15,44	30,32	53,32	59,25	
35		4,80	5,59	6,44	10,02	17,12	31,07	56,73	63,03	
40		5,59	6,62	7,41	11,26	18,82	32,67	60,03	66,70	166,98
45		9,00	8,70	8,84	12,48	20,64	34,60	64,51	71,67	174,54
50		10,38	10,48	10,59	13,66	23,20	37,42	69,07	76,75	182,10
55				13,41	17,17	26,25	41,06	74,60	82,90	189,72
60				16,25	19,89	31,59	44,05	80,19	89,10	200,37
65				21,95	24,14	37,96	51,70	106,91	118,79	218,83
70				21,95	24,14	37,96	51,70	106,91	118,79	218,83
80				24,08	30,56	50,26	68,37	145,71	161,90	257,43
90				27,10	45,45	62,63	121,21	186,58	186,58	373,17
100				30,22	54,53	77,87	145,45	213,24	213,24	426,47
110				55,92	82,28	133,27	169,29	226,75	226,75	452,47
120				64,24	96,45	145,03	193,59	255,88	255,88	511,77
130							218,70		284,20	534,55
140							234,90		312,93	575,59
150							251,10		341,66	608,42

**PARAFUSOS CABEÇA CHATA
COM SEXTAVADO INTERIOR
DIN 7991 - INOX-A2**



**DESCIDA
DE
PREÇO**

• **INOX-A2**

DIÂM. COMP. (mm)	M-3	M-4	M-5	M-6	M-8	M-10	M-12	M-14	M-16	M-20
6	1,11	1,67								
8	0,92	1,37	2,14	4,30						
10	0,94	1,47	2,35	4,00	9,00					
12	1,05	1,55	2,41	3,25	7,63					
16	1,22	1,89	2,76	3,88	6,53	20,88				
20	1,37	2,18	3,11	4,44	7,69	13,58	26,82			
25	2,05	2,62	3,63	5,04	8,89	14,59	28,39		140,42	
30	2,34	2,98	4,45	6,25	10,14	16,50	29,50		114,27	
35		4,04	5,18	6,82	11,22	18,81	30,19		122,49	
40		4,94	5,92	7,42	11,74	20,11	32,34		129,21	208,37
45		9,20	6,73	8,84	14,69	22,41	35,19		136,67	222,58
50		11,52	7,61	9,55	17,09	24,74	37,12		144,90	238,26
55				10,55	18,11	32,20	49,00		161,34	253,19
60				11,47	20,45	32,20	49,00		161,34	266,63
70				12,97	23,83	39,34	58,79		183,71	296,51
80				14,07	27,20	52,40	68,94		203,88	348,05
90				28,79	46,04	64,24	99,49		221,83	383,15
100				31,62	51,50	70,42	108,23		239,75	425,71
120					87,64				372,68	

**PARAFUSOS CABEÇA CHATA
COM SEXTAVADO INTERIOR
DIN 7991 - INOX-A4**



**DESCIDA
DE
PREÇO**

• **INOX-A4**

DIÂM. COMP. (mm)	M-3	M-4	M-5	M-6	M-8	M-10	M-12	M-14	M-16	M-20
6	3,00	3,75								
8	3,04	3,80	5,61	8,13						
10	3,15	3,93	5,61	7,56						
12	3,28	4,09	5,23	6,16	13,96					
16	3,41	4,26	5,60	7,34	14,48	50,92				
20	3,85	4,82	6,21	8,40	16,97	33,11	75,10			
25		5,19	7,74	9,52	18,11	35,69	79,70			
30		5,62	9,11	11,81	19,94	40,24	82,80			
35			11,54	12,92	23,87	45,84	84,65			
40			13,10	14,02	26,29	48,88	90,64			
45				17,01	32,21	54,70	98,60			
50				19,36	37,15	60,39	104,21			
55										
60				27,43	47,40	78,53	137,50			
70				36,10	58,62	95,94	165,02			
80						127,85	193,55			
90										
100										
120										

**PARAFUSOS CABEÇA OVAL
COM SEXTAVADO INTERIOR
ISO 7380 - 10.9 - PRETO**



• PRETO

DIÂM. COMP. (mm)	M-3	M-4	M-5	M-6	M-8	M-10	M-12	M-14	M-16	M-20
8	4,74	3,05	2,88	3,56						
10	2,71	2,71	2,71	3,39	5,72					
12	2,71	2,71	2,71	3,39	5,34					
16	2,88	2,88	2,88	3,56	5,34	15,27				
20	3,05	3,05	3,05	3,73	5,72	11,44	24,80			
25	3,23	3,22	3,22	3,90	6,49	11,82	22,90			
30	3,40	3,39	3,39	4,23	6,87	12,59	24,80			
35		4,40	3,73	4,74	7,63	14,12	26,72			
40		4,56	4,40	5,08	9,54	15,27	28,62			
45			5,08	6,10	13,35	17,18	30,52			
50			6,78	10,17	13,35	19,08	32,44			
55				11,87	17,18	20,99	34,34			
60				13,57	20,99	22,90	36,25			
70					30,52	28,62	41,97			
80					30,61	37,62	52,67			
90					38,98	41,86	58,59			
100					42,92	45,50	63,71			

**PARAFUSOS CABEÇA OVAL
COM SEXTAVADO INTERIOR
ISO 7380 - 10.9 - ZINCADO**



• ZINCADO

DIÂM. COMP. (mm)	M-3	M-4	M-5	M-6	M-8	M-10	M-12	M-14	M-16	M-20
8	5,93	3,90	3,73	4,57						
10	3,39	3,39	3,39	4,23	7,25					
12	3,39	3,39	3,39	4,23	6,68					
16	3,73	3,73	3,73	4,57	6,68	19,08				
20	3,90	3,90	3,90	4,74	7,25	14,31	31,10			
25	4,08	4,07	4,07	4,91	8,20	14,88	28,62			
30	4,25	4,23	4,23	5,42	8,59	15,84	31,10			
35		5,10	4,74	5,93	9,54	17,74	33,39			
40		5,78	5,59	6,44	12,02	19,08	35,87			
45			6,44	7,63	16,80	21,56	38,16			
50			8,48	12,72	16,80	23,84	40,64			
55				13,57	21,56	26,33	42,93			
60				16,28	26,33	28,62	45,41			
70					33,24	35,87	52,46			
80					36,01	44,26	61,97			
90					45,87	49,23	68,94			
100					50,48	53,53	74,94			

**PARAFUSOS CABEÇA OVAL
COM SEXTAVADO INTERIOR
ISO 7380 - INOX-A2**



• AÇO INOX-A2

DIÂM. COMP. (mm)	M-3	M-4	M-5	M-6	M-8	M-10	M-12	M-14	M-16	M-20
8		2,83	3,83							
10		2,72	4,15	5,14						
12		3,02	4,15	5,42						
16		3,02	4,47	5,53	10,95	25,30				
20		3,43	4,89	6,19	12,19	27,22				
25		3,93	5,85	7,14	13,52	29,74				
30		5,04	7,45	8,00	15,71	31,45				
35		6,05	8,51	9,04	17,71	34,17				
40		7,06	10,11	10,57	19,90	36,49				
45				12,47	21,80	40,52				
50				13,90	24,75	45,77				
55					30,07	48,89				
60					32,35	55,34				

**PERNOS ROSCADOS
COM SEXTAVADO INTERIOR
DIN 916 - ISO 4029 - 45 H**



• **AÇO CLASSE DE RESISTÊNCIA 45 H**

Ø	M-3	M-4	M-5	M-6	M-8	M-10	M-12	M-16	M-20	M-24
L										
3	1,13									
4	1,13	0,83								
5	1,13	0,83	0,90							
6	1,20	0,91	0,90	1,20						
8	1,35	1,03	1,08	1,28	1,65					
10	1,50	1,08	1,16	1,35	1,90	3,06				
12	1,65	1,24	1,32	1,65	2,23	3,14	6,00			
16	2,25	1,98	2,08	2,07	2,97	4,13	6,75	32,80		
20	2,78	2,70	2,70	2,56	4,06	5,86	8,25	37,50	89,90	
25	5,25	3,61	3,34	3,42	5,40	8,10	12,60	45,00	97,50	
30	6,00	5,37	4,96	5,04	6,30	9,90	16,20	52,50	105,00	183,00
35		6,83	6,83	6,30	7,20	12,60	19,80	60,00	112,50	195,50
40		7,80	7,80	7,20	10,80	15,30	23,40	67,50	120,00	220,50
45			9,75	9,00	12,60	19,80	27,00	75,00	127,50	329,30
50			11,70	10,80	14,40	22,50	31,50	82,50	135,00	386,80
60				18,00	22,50	31,50	40,50	90,00	187,50	391,90
70					37,30	57,80	103,10	105,00	225,00	506,90
80					46,20	71,20	160,20	99,00	362,20	555,70
90								127,60	433,00	574,20
100								135,10	608,60	791,40

**PERNOS ROSCADOS
COM SEXTAVADO INTERIOR
DIN 916 - ISO 4029 - INOX A2**



• **AÇO INOX A2**

Ø	M-3	M-4	M-5	M-6	M-8	M-10	M-12	M-16	M-20	M-24
L										
3	2,31									
4	2,31	2,21								
5	2,42	2,21	2,50							
6	2,52	2,31	2,60	2,90						
8	2,63	2,42	2,80	3,20	6,00					
10	2,73	2,52	2,90	3,90	7,00	12,00				
12	2,84	2,63	3,50	4,60	9,00	15,00	25,00			
16	3,99	3,26	4,50	5,90	12,00	22,00	30,00	65,00		
20	5,99	3,89	6,00	8,50	16,00	30,00	40,00	75,00		
25		6,20	9,00	10,80	21,00	40,00	50,00	90,00		
30		7,56	12,00	14,00	27,00	47,00	60,00	110,00		
35			16,00	17,00	35,00	55,00	70,00	130,00		
40			20,00	22,00	40,00	60,00	80,00	150,00		
45				30,00	45,00	70,00	90,00	180,00		
50				35,00	50,00	80,00	100,00	210,00		
60					62,00	90,00	120,00	250,00		
70					80,00	130,00	220,00	300,00		
80					95,00	170,00	320,00	350,00		

**PERNOS ROSCADOS
COM SEXTAVADO INTERIOR
DIN 914 - ISO 4027 - 45 H**



• **AÇO CLASSE DE RESISTÊNCIA 45 H**

Ø	M-3	M-4	M-5	M-6	M-8	M-10	M-12	M-16	M-20	M-24
L										
3	3,70									
4	2,98	3,24								
5	3,06	2,80	3,24							
6	3,16	2,80	2,88	3,60						
8	3,24	2,88	2,98	3,24	4,42					
10	3,60	3,06	3,16	3,34	4,42	9,00				
12	3,96	3,34	3,52	3,70	4,78	8,10	17,10			
16	6,76	4,68	3,96	4,32	6,40	9,90	17,10			
20	7,92	5,58	5,32	5,40	7,48	11,70	19,80			
25		8,46	8,64	7,66	9,64	13,50	23,40			
30		10,00	10,00	9,72	11,26	16,20	27,00			
35			12,88	13,50	13,50	21,60	32,40			
40			13,86	15,30	15,30	25,20	35,10			
45				17,10	21,60	29,70	41,40			
50				18,90	24,30	34,20	45,00			
60										

**PERNOS ROSCADOS
COM SEXTAVADO INTERIOR
DIN 914 - ISO 4027 - INOX A2**



• **AÇO INOX A2**

Ø	M-3	M-4	M-5	M-6	M-8	M-10	M-12	M-16	M-20	M-24
L										
3	3,32									
4	3,32	3,03								
5	3,42	3,03	3,61							
6	3,51	3,22	3,61	4,39						
8	3,61	3,42	3,81	4,39	7,02					
10	3,71	3,71	4,20	4,68	7,32	13,65				
12	3,81	3,71	4,49	4,88	7,90	13,65	23,40			
16	5,66	5,37	5,56	5,95	8,97	14,63	25,35			
20	7,90	6,44	6,63	7,41	12,48	17,55	29,25	54,60		
25		10,73	8,29	9,07	14,43	21,45	33,15	64,35		
30		17,55	10,73	13,17	16,58	25,35	37,05	73,13		
35			16,58	17,55	18,53	29,25	42,90	81,90		
40			18,53	22,43	21,45	35,10	46,80	90,68		
45				27,30	25,35	43,88	62,40	113,10		
50				31,20	29,25	48,75	64,35	121,88		
60								129,68		

**CHAVE SEXTAVADA "UMBRAKO"
DIN 911
ZINCADA**



• **AÇO ZINCADO**

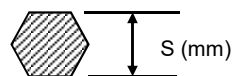

S (mm)	1,5	2	2,5	3	4	5	6	8
PREÇO	2,91	3,38	4,76	5,71	9,44	12,86	24,91	63,62

**PARAFUSOS ROSCA DE METAIS
DIN 84 - ZINCADO E INOX-A2**



• AÇO ZINCADO • AÇO INOX-A2

DIÂM. COMP. (mm)	M-3		M-4		M-5		M-6		M-8		M-10	
	ZINCADO	INOX-A2	ZINCADO	INOX-A2	ZINCADO	INOX-A2	ZINCADO	INOX-A2	ZINCADO	INOX-A2	ZINCADO	INOX-A2
5	0,86											
6	0,86	2,16	1,51	3,25	2,74							
8	0,88	2,34	1,49	3,43	2,59	5,81	4,00	6,87				
10	0,97	2,44	1,52	3,43	2,60	5,88	4,12	7,28	8,17	16,23		
12	1,04	2,70	1,70	3,63	2,74	6,24	4,30	7,73	8,70	17,12		
16	1,15	2,88	1,91	4,03	3,07	7,06	4,78	8,75	9,36	19,52		
20	1,31	3,39	2,24	4,54	3,59	7,83	5,16	9,58	10,22	21,08	17,89	
25	1,52	4,00	2,59	5,21	4,12	9,07	5,99	10,60	11,42	24,02	19,62	
30	1,76	4,51	2,98	5,85	4,78	10,01	6,83	11,69	12,94	26,32	21,28	
35			3,29	7,48	5,30	11,37	7,64	13,62	14,32	28,56	23,87	
40			3,76	9,16	6,14	12,38	8,52	15,05	15,88	30,97	26,41	
45			4,43	12,40	6,83	15,53	9,36	19,01	17,89	33,08	28,12	
50			5,14	15,76	7,64	16,66	10,22	20,89	19,62	35,77	30,70	
55					10,22		11,06	24,50	22,15	45,64	34,13	
60					11,06		11,92	24,50	23,87	45,64	35,76	
70												

**PARAFUSOS ROSCA DE METAIS
DIN 963; DIN 965 - ZINCADO E INOX-A2**



DIN 963

DIN 965

• AÇO ZINCADO • AÇO INOX-A2

DIÂM. COMP. (mm)	M-3		M-4		M-5		M-6		M-8		M-10	
	ZINCADO	INOX-A2	ZINCADO	INOX-A2	ZINCADO	INOX-A2	ZINCADO	INOX-A2	ZINCADO	INOX-A2	ZINCADO	INOX-A2
5	0,72											
6	0,72	1,93	1,28	3,42	2,28							
8	0,74	2,04	1,20	3,42	2,14	4,82	3,34	7,07				
10	0,82	2,13	1,30	3,46	2,15	5,14	3,43	7,07	6,80			
12	0,88	2,32	1,44	3,67	2,28	5,46	3,58	7,07	7,22	13,44		
16	0,97	2,59	1,60	4,17	2,59	5,94	4,00	8,15	7,79	15,60		
20	1,10	2,94	1,86	4,55	3,00	6,44	4,32	8,83	8,52	17,71	12,43	
25	1,30	3,46	2,14	5,28	3,43	7,73	4,98	9,90	9,52	20,55	13,62	
30	1,49		2,46	5,98	4,00	8,48	5,71	11,33	10,78	23,37	14,76	
35			2,77	6,64	4,42	9,31	6,40	12,74	11,92	26,21	16,55	
40			3,16	8,04	5,14	10,92	7,08	17,71	13,21	28,32	18,34	
45			3,73	10,92	5,71	14,80	7,79	19,84	14,92	31,86	19,51	
50			4,30	12,21	6,40	16,10	8,52	22,67	16,34	35,38	21,31	
55					8,52		9,24		18,46		23,68	
60					9,24		9,92	24,79	19,86	42,48	24,85	
70												

**PARAFUSOS ROSCA DE METAIS
DIN 7985 - ZINCADO E INOX-A2**



• AÇO ZINCADO • AÇO INOX-A2

DIÂM. COMP. (mm)	M-3		M-4		M-5		M-6		M-8		M-10	
	ZINCADO	INOX-A2	ZINCADO	INOX-A2	ZINCADO	INOX-A2	ZINCADO	INOX-A2	ZINCADO	INOX-A2	ZINCADO	INOX-A2
5	0,88											
6	0,88	2,16	1,55	3,58	2,82							
8	0,94	2,16	1,52	3,35	2,65	6,44	4,14	12,28				
10	1,00	2,24	1,57	3,58	2,70	6,44	4,27	10,64			22,82	
12	1,10	2,44	1,78	3,70	2,82	7,13	4,43	10,64			22,82	
16	1,21	2,74	1,99	4,27	3,22	7,48	4,96	11,86	10,08	22,82		
20	1,34	3,00	2,30	4,70	3,73	8,20	5,40	13,10	10,85	24,93		
25	1,57	3,42	2,65	5,35	4,27	9,63	6,23	14,76	11,75	26,36		
30	1,86	3,77	3,08	6,05	4,96	10,68	7,10	15,60	13,03	29,20		
35			3,43	8,20	5,51	12,82	7,94	16,39	14,52	32,06		
40			3,91	8,55	6,40	14,25	8,83	18,83	15,56	34,19		
45			4,62		7,10	15,68	9,72	20,48	17,53	37,04		
50			5,32		7,94	17,81	10,62	22,15	19,44	41,31		
55					10,62		11,51					
60					11,51		12,37	28,70	24,23	49,87		
70												

PARAFUSOS AUTO-ROSCANTES DIN 7981



• AÇO ZINCADO • AÇO INOX-A2

DIÂM. (mm / N.º)		2,9		3,5		3,9		4,2		4,8		5,5		6,3	
COMPRIMENTO		4		6		7		8		10		12		14	
(mm)	W(º)	ZINCADO	INOX-A2	ZINCADO	INOX-A2	ZINCADO	INOX-A2	ZINCADO	INOX-A2	ZINCADO	INOX-A2	ZINCADO	INOX-A2	ZINCADO	INOX-A2
6,5	"1/4	0,87	2,98	1,18	3,20										
9,5	"3/8	0,99	2,09	1,07	2,88	1,34	2,92	1,53	4,03	2,20	5,15				
13	"1/2	1,09	2,09	1,21	2,78	1,55	3,20	1,76	3,89	2,29	5,73	3,34	8,77		
16	"5/8	1,25	2,30	1,38	3,15	1,62	3,59	1,94	4,32	2,51	6,27	3,65	8,76		
19	"3/4	1,34	2,47	1,51	3,39	1,75	4,01	2,08	4,76	2,78	6,84	3,96	9,78		
22	"7/8	1,58	2,70	1,66	3,71	1,96	4,40	2,38	5,18	3,11	7,41	4,19	10,67		
25	1"	1,94	2,89	1,88	4,01	2,06	4,84	2,51	5,64	3,22	8,10	4,65	11,43		
32	1"1/4			2,44	5,01	2,82	5,91	2,89	7,06	3,80	9,78	5,38	13,44		
38	1"1/2			3,40	5,61	3,32	6,84	3,32	7,92	4,31	11,04	6,05	15,09		
45	1"3/4							4,75	8,96	5,01	12,36	6,96	16,82		
50	2"							5,29	10,07	5,31	14,01	7,28	18,30		
63	2"1/2									7,44	16,57	9,68	21,11		
70	3"									10,10	18,76	12,64	23,83		
80											22,01		27,52		

Zincagem Cr3+
de acordo com RoHS



PARAFUSOS AUTO-ROSCANTES DIN 7982







• AÇO ZINCADO • AÇO INOX-A2

DIÂM. (mm / N.º)		2,9		3,5		3,9		4,2		4,8		5,5		6,3	
COMPRIMENTO		4		6		7		8		10		12		14	
(mm)	W(º)	ZINCADO	INOX-A2	ZINCADO	INOX-A2	ZINCADO	INOX-A2	ZINCADO	INOX-A2	ZINCADO	INOX-A2	ZINCADO	INOX-A2	ZINCADO	INOX-A2
6,5	"1/4	0,96	3,15												
9,5	"3/8	0,96	2,01	1,09	2,46	1,44	2,84								
13	"1/2	1,09	2,00	1,09	2,46	1,58	2,84	1,58	3,37	2,16	4,75	3,61	7,44		
16	"5/8	1,21	2,21	1,44	2,74	1,69	3,17	1,84	3,81	2,41	5,43	3,83	7,41		
19	"3/4	1,34	2,46	1,58	3,05	1,84	3,52	2,06	4,22	2,51	5,91	3,97	8,29		
22	"7/8	1,58	2,70	1,69	3,37	1,91	3,91	2,16	4,76	2,89	6,39	4,21	9,27		
25	1"	1,84	2,84	1,91	3,70	2,16	4,32	2,51	5,15	3,01	6,98	4,81	9,91		
32	1"1/4			2,41	4,57	3,01	5,36	2,89	6,51	3,61	8,65	5,58	11,67		
38	1"1/2			3,61	5,15	3,83	6,22	3,36	7,50	4,21	10,12	6,31	13,33		
45	1"3/4							4,81	8,57	5,35	11,18	7,18	15,36		
50	2"							5,98	9,71	5,50	12,74	7,76	16,70		
63	2"1/2									8,38	14,84	10,79	19,81		
70	3"									14,36	17,46	21,52	21,97		
80											20,48		25,17		

Zincagem Cr3+
de acordo com RoHS

		PARAFUSOS DE AÇO FOSFATADO PARA PLADUR				
• AÇO FOSFATADO					Cada caixa de 1000 unidades inclui um bit PH2	
L (mm)	25	35	45	55	65	
Ø (mm)	3,5		0,99		1,37	
3,5	0,99		1,37		1,86	
2,11		2,11		2,11		

		PARAFUSOS DE AÇO FOSFATADO AUTO-PERFORANTE PARA PLADUR				
• AÇO FOSFATADO						
L (mm)	25	35	45	55	65	
Ø (mm)	3,5		1,13		1,43	
3,5	1,13		1,43		1,93	
2,47		2,47		2,47		

		PARAFUSOS AUTO-ROSCANTES CABEÇA SEXTAVADA COM ANILHA FALSA SIMPLES OU MONTADO COM ANILHA EPDM		
• AÇO ZINCADO				
Ø (mm)	6,3 SIMPLES		6,3 MONTADO COM EPDM Ø19	
L (mm)	16		7,04	
16	4,04		7,04	
19	4,04		7,04	
25	4,58		7,64	
32	5,22		8,99	
38	5,81		9,18	
50	7,18		10,62	
63	8,53		12,13	
75	9,74		14,13	
90	12,38		16,58	
100	13,91		18,70	
110	17,10		22,19	
120	18,87		24,23	
130	21,37		27,22	

**PARAFUSOS AUTO-PERFORANTES
CABEÇA SEXTAVADA - DIN 7504-K
SIMPLES OU MONTADO COM ANILHA EPDM**



• **AÇO ZINCADO**

Ø (mm)	3,5	4,2	4,8		5,5			6,3		
COMP.	SIMPLES	SIMPLES	SIMPLES	EPDM Ø16	SIMPLES	EPDM Ø19	EPDM Ø25	SIMPLES	EPDM Ø19	EPDM Ø25
13	1,18	1,35	1,56							
16	1,24	1,46	1,71	3,83						
19	1,34	1,59	1,86	3,97	2,45	5,34	7,66	3,66	6,71	9,14
22	1,43	1,69	1,98	4,12	2,64	5,48	7,79	3,92	7,03	9,47
25	1,54	1,79	2,08	4,29	2,78	5,64	7,98	4,14	6,78	9,72
32	1,86	2,09	2,64	4,68	3,28	6,24	8,63	4,72	7,47	10,57
38		2,30	3,02	5,10	3,59	6,66	9,05	5,22	8,19	11,42
50		2,70	3,56	5,79	4,37	7,75	10,22	6,37	9,32	11,72
63			4,45		5,22	8,80	11,40	7,62	10,69	13,18
75								8,58	12,72	15,61
90								11,60	16,16	18,46
100								12,96	17,72	20,28
115								16,76	22,47	23,85
125								18,87	24,69	26,61
130								20,98	27,45	28,58
140								23,72	30,67	32,18
150								26,33	33,75	35,96
160								31,27	40,36	43,19
180								47,17	58,98	61,20
200								54,28	67,10	69,53

**PARAFUSOS AUTO-PERFORANTES
CABEÇA SEXTAVADA - DIN 7504-K
INOX-A2**



• **INOX-A2**

SÓ PARA APLICAÇÕES EM ALUMÍNIO

L (mm)	13	16	19	22	25	32	38	50	60
Ø (mm)									
3,5	3,52								
4,2	4,98	5,13	5,59		5,97				
4,8		6,66	6,97		7,80	9,03	10,03		
5,5			9,18	9,95	11,17	12,39	13,85	16,83	19,13

ACESSÓRIOS

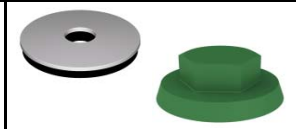

ANILHAS VULCANIZADAS EPDM

TAMPAS EM NYLON



DIÂMETRO	INOX	ZINCADO
14	5,05	1,84
16	5,90	2,07
19	6,73	2,53
25	12,63	4,37



PARA PARAFUSOS 6,3 (SXT 10) E 5,5 (SXT 8)
TODAS AS CORES

TAMANHO	5,5 (SXT 8)	6,3 (SXT 10)
PREÇO	2,35	2,35

**PARAFUSOS AUTO-PERFURANTES
CABEÇA SEXTAVADA EM NYLON
(INJETADA)**



• AÇO ZINCADO / NYLON INJETADO

CORES DISPONÍVEIS



PARAFAST
NOVO

RAL 1014 CREME	RAL 1015 CREME CLARO	RAL 1019 CREME ESCURO	RAL 1023 AMARELO	RAL 3000 VERMELHO	RAL 3009 VERMELHO FERRUGEM
RAL 3011 BORDEAUX ESCURO	RAL 3013 BORDEAUX	RAL 3016 BORDEAUX CLARO	RAL 5010 AZUL	RAL 5012 AZUL CLARO	RAL 5018 AZUL TURQUESA
RAL 6002 VERDE	RAL 6005 VERDE GARRAFA	RAL 6012 VERDE ESCURO	RAL 7016 CINZA ANTRACITE	RAL 7035 CINZA CLARO	RAL 7037 CINZA ESCURO
RAL 8002 CASTANHO CLARO	RAL 8014 CASTANHO ESCURO	RAL 9003 BRANCO	RAL 9005 PRETO	RAL 9006 CINZA METAL. CLARO	RAL 9007 CINZA METAL. ESCURO

COMPRIMENTO	19	22	25	32	38	50	63
DIÂM. (mm / N.º)							
Ø 4,2	4,75						
Ø 5,5		5,70		8,55	9,50	10,93	12,83

**PARAFUSOS AUTO-PERFURANTES
PARA PAINEL SANDWICH
SIMPLES E MONTADO COM ANILHA EPDM**



• AÇO ZINCADO

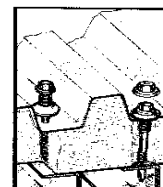

COMPRIMENTO		100	115	130	150	180
DIÂM. (mm)	MONTAGEM					
5,5 / 6,3	SIMPLES	13,46	15,38	17,83	22,27	36,95
	C/ EPDM Ø19	16,15	18,14	20,66	25,40	40,17
	C/ EPDM Ø25	18,21	20,12	22,57	27,47	42,84

**PARAFUSOS AUTO-PERFURANTES
PARA PAINEL SANDWICH
CABEÇA SEXTAVADA EM NYLON (INJETADA)**



• AÇO ZINCADO / NYLON INJETADO

MONTADO COM ANILHA DE VEDAÇÃO



PARAFAST

CORES DISPONÍVEIS

RAL 9003 BRANCO	RAL 8004 TELHA	RAL 6005 VERDE GARRAFA	RAL 9006 CINZA METAL. CLARO	RAL 7035 CINZA CLARO	RAL 5010 AZUL
---------------------------	--------------------------	----------------------------------	---------------------------------------	--------------------------------	-------------------------

COMPRIMENTO	100	115	130	150	180
DIÂMETRO. (mm)					
5,5 / 6,3	20,00	22,00	25,00	32,00	50,00

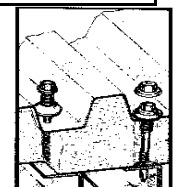

**PARAFUSOS AUTO-PERFURANTES
CABEÇA DE QUEIJO - DIN 7504-N
ZINCADO - INOX-A2**



**DESCIDA
DE
PREÇO**

• AÇO ZINCADO • AÇO INOX A-2 (SÓ PARA ALUMÍNIO)

DIÂM.	3,5		3,9		4,2		4,8		5,5	
COMP. (mm)	ZINCADO	INOX-A2	ZINCADO	INOX-A2	ZINCADO	INOX-A2	ZINCADO	INOX-A2	ZINCADO	INOX-A2
9,5	0,68	2,07								
13	0,76	2,34	0,92	2,62	0,97	2,90	1,28	4,42		
16	0,87	2,59	0,99	2,90	1,04	3,20	1,42	4,67	2,34	6,52
19	0,94	2,86	1,07	3,49	1,15	3,63	1,55	5,19	2,45	6,93
22	1,02	3,12	1,14	3,77	1,23	3,91	1,65	5,45	2,66	7,41
25	1,13	3,37	1,21	4,06	1,32	4,06	1,76	5,70	2,82	7,71
32			1,46	4,35	1,71	4,64	2,26	6,74	3,41	9,22
38			1,60	4,94	1,90	5,22	2,54	7,26	3,77	10,02
45					2,10	6,95	2,89	8,56	4,15	12,07
50					2,26	7,25	3,17	9,08	4,51	12,78
60							3,88	10,38	5,37	16,35

**PARAFUSOS AUTO-PERFURANTES
CABEÇA CHATA - DIN 7504-P
ZINCADO - INOX-A2**



**DESCIDA
DE
PREÇO**

• AÇO ZINCADO • AÇO INOX A-2 (SÓ PARA ALUMÍNIO)

DIÂM.	3,5		3,9		4,2		4,8		5,5	
COMP. (mm)	ZINCADO	INOX-A2	ZINCADO	INOX-A2	ZINCADO	INOX-A2	ZINCADO	INOX-A2	ZINCADO	INOX-A2
9,5	0,62	2,07								
13	0,70	2,34	0,78	2,62	0,88	2,90	1,20	4,42		
16	0,74	2,59	0,84	2,90	0,98	3,20	1,31	4,67	1,98	6,52
19	0,81	2,86	0,92	3,49	1,07	3,63	1,41	5,19	2,10	6,93
22	0,88	3,12	0,99	3,77	1,15	3,91	1,51	5,45	2,26	7,41
25	0,94	3,37	1,04	4,06	1,23	4,06	1,63	5,70	2,41	7,71
32			1,24	4,35	1,46	4,64	1,94	6,74	2,93	9,22
38			1,36	4,94	1,63	5,22	2,17	7,26	3,21	10,02
45					1,80	6,95	2,46	8,56	3,55	12,07
50					1,94	7,25	2,72	9,08	3,86	12,78
60							3,34	10,38	4,57	16,35

**PARAFUSOS AUTOOPERFURANTES
CABEÇA SEXTAVADA - PARA VIGAS
SIMPLES OU MONTADO COM ANILHA EPDM**



• **AÇO ZINCADO**

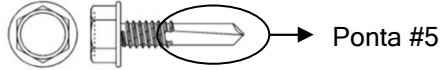

ØxL (mm)	SIMPLES		EPDM Ø16		EPDM Ø19		EPDM Ø25	
		PREÇO		PREÇO		PREÇO		PREÇO
5,5x32	500	7,12	500	9,63	200	10,52	200	13,53
5,5x38	500	7,61	500	10,16	200	11,12	200	14,09
5,5x50	500	9,20	200	11,87	200	12,85	200	15,94
5,5x60	500	11,77	200	14,63	200	15,62	200	18,97

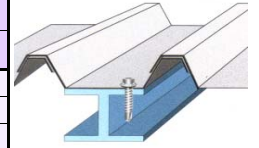

**PARAFUSOS AUTOOPERFURANTES
CABEÇA LARGA - PHILIPS**



• **AÇO ZINCADO**

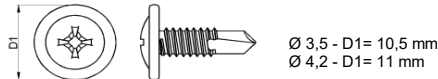

L (mm)	9,5		13		16		19		25		32	
Ø (mm)		PREÇO		PREÇO		PREÇO		PREÇO		PREÇO		PREÇO
3,5	1000	1,08	1000	1,25	1000	1,35	1000	1,47	1000	1,74		
4,2			1000	1,36	1000	1,45	1000	1,58	1000	1,81	1000	2,20

**PARAFUSOS AUTOOPERFURANTES
PARA CARROCERIAS - PHILIPS**



• **AÇO ZINCADO**

Ø (mm)	4,2		4,8		5,5		6,3	
L (mm)		PREÇO		PREÇO		PREÇO		PREÇO
25			500	2,99				
32			500	3,30				
38	500	2,96	500	3,70	500	4,86		
45			500	4,11	500	5,40		
50			500	4,53	500	5,80		
60					500	6,75	200	8,67
70							200	10,26
85							200	12,89

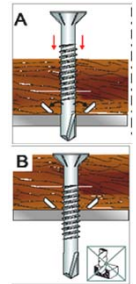

**PARAFUSOS AUTOOPERFURANTES
PARA CARROCERIAS - TORX**



• **AÇO ZINCADO**

Ø (mm)	4,2		4,8		5,5 (TX 25)		6,3 (TX 30)	
L (mm)		PREÇO		PREÇO		PREÇO		PREÇO
38					200	5,38		
40							200	7,18
45					200	5,99		
50					200	6,63	200	7,83
55							100	9,00
60					100	7,56	100	9,31
65							100	10,50
70/60					100	9,57	100	11,25
80/70					100	10,77	100	12,65
100/70					100	13,46	100	15,84
120/70							100	19,95

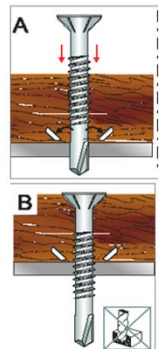

**PARAFUSO ESPECIAL
PARA ROSCAR NO BETÃO**



• **AÇO COM TRATAMENTO BLUE RUSPERT**

L (mm)	32		45		57		70		80		100		115		125		150	
Ø (mm)		PREÇO		PREÇO		PREÇO		PREÇO		PREÇO		PREÇO		PREÇO		PREÇO		PREÇO
6,5	500	6,58	200	7,71	200	9,67	200	11,64	200	14,98	100	17,31	100	20,96	100	23,72	100	30,31



**PARAFUSOS AUTO-PERFURANTES CABEÇA SEXTAVADA - PONTA #1
ENTRE FACES 10mm- SIMPLES E COM EPDM**



• **AÇO ZINCADO**

ØxL (mm)	SIMPLES		EPDM Ø16		EPDM Ø19		EPDM Ø25	
		PREÇO		PREÇO		PREÇO		PREÇO
6,3x25	500	6,82	500	9,44	500	10,90	500	14,19

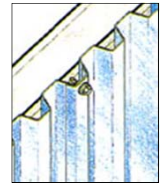

**PARAFUSOS AUTO-PERFURANTES CABEÇA SEXTAVADA - PONTA #1
ENTRE FACES 8mm - SIMPLES E COM EPDM**



• **AÇO ZINCADO**

ØxL (mm)	SIMPLES		EPDM Ø16		EPDM Ø19		EPDM Ø25	
		PREÇO		PREÇO		PREÇO		PREÇO
4,8x16	1000	3,01	1000	5,01				
4,8x19	1000	3,21	1000	5,23				
5,5x22	500	5,01	500	6,77	500	7,99	500	11,15
6,3x20	500	5,38	500	7,36	500	8,58	500	11,81
6,3x25	500	6,35	500	8,03	500	9,54	500	12,84
6,3x32	500	7,06	500	9,04	500	10,54	500	13,92
6,3x38	500	7,87	500	10,04	500	11,23	500	14,70
6,3x50	200	10,09	200	12,14	200	13,42	200	17,05
6,3x63	200	12,02	200	14,11	200	15,35	200	19,14
6,3x80	100	13,89	100	16,21	100	17,60	100	21,57

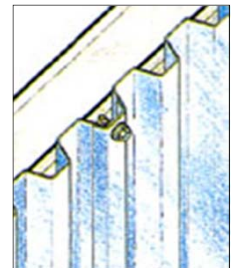

PARAFUSOS AUTO-PERFURANTES PARA FIBROCIMENTO COM ANILHA GUARDA-CHUVA INOX



• **AÇO ZINCADO**

PONTA #5

L (mm)	110		120		130		150	
Ø (mm)		PREÇO		PREÇO		PREÇO		PREÇO
6,3	100	45,13	100	47,89	100	53,48	100	58,32



PARAFUSOS AUTO-PERFURANTES CABEÇA DE EMBEBER - PHILIPS PARA ISOLAMENTOS (COBERTURAS DECK)



• **AÇO ZINCADO**

PONTA REDUZIDA #1

L (mm)	60		70		80		90		100		110		120		130		150	
Ø (mm)		PREÇO		PREÇO		PREÇO		PREÇO		PREÇO		PREÇO		PREÇO		PREÇO		PREÇO
4,8	500	7,96	500	9,35	500	10,84	200	12,72	200	14,74	200	16,51	200	18,90	200	19,70	200	25,79

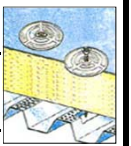

ANILHAS DE CHAPA PARA ISOLAMENTOS (COBERTURAS DECK)

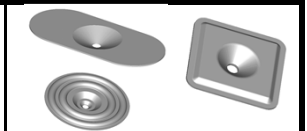

• **CHAPA DE AÇO COM REVESTIMENTO ALUZINC**

RECTANGULAR 80 x 40 mm		QUADRADA 40 x 40 mm		CIRCULAR Ø 70 mm	
	PREÇO		PREÇO		PREÇO
100	26,40	100	14,40	100	26,40

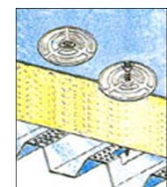

**PARAFUSOS CABEÇA CHATA PZD
PARA AGLOMERADO DE MADEIRA**



• **AÇO ZINCADO BRANCO / AMARELO**

**DESCIDA
DE
PREÇO**

DIÂMETRO	2,5	3	3,5	4	4,5	5	6
COMPRIM. (mm)							
12	0,47	0,41	0,52				
16	0,48	0,41	0,53	0,59	0,73	1,15	
18	0,56	0,47	0,60	0,66	0,83	1,17	
20	0,59	0,48	0,62	0,67	0,85	1,21	
25		0,59	0,72	0,78	1,00	1,22	
30		0,66	0,83	0,90	1,17	1,46	
35		0,74	0,94	1,04	1,37	1,67	
40		0,86	1,09	1,15	1,54	1,84	3,07
45		1,00	1,20	1,33	1,67	2,07	3,19
50		1,18	1,31	1,46	1,84	2,26	3,29
55				1,67	2,17	2,57	3,85
60				1,71	2,23	2,66	3,91
70				2,21	2,63	3,06	4,52
80						3,46	5,13
90						4,12	5,74
100						4,80	6,47
110							7,92
120							8,81
130							10,49
140							11,10
150							12,72
160							18,90
180							21,60
200							24,30

**DESCIDA
DE
PREÇO**

**PARAFUSOS CABEÇA CHATA PZD
PARA AGLOMERADO DE MADEIRA
AÇO INOX-A2**



• **AÇO INOX-A2**

**DESCIDA
DE
PREÇO**

DIÂMETRO	2,5	3	3,5	4	4,5	5	6
COMPRIM. (mm)							
12	1,73	1,09	1,73				
16	1,74	1,26	1,41	1,81	2,40	3,14	
18	2,11	1,39	1,57	2,00	2,63	3,14	
20	2,11	1,39	1,57	2,00	2,63	3,21	
25		1,57	1,81	2,30	2,96	3,68	
30		1,73	2,07	2,67	3,32	4,13	
35		2,00	2,40	2,98	3,75	4,58	
40		2,21	2,66	3,28	4,08	5,08	7,95
45		2,54	2,93	3,57	4,45	5,53	8,63
50		2,77	3,17	3,92	4,77	5,95	9,33
55				4,63	5,42	6,86	10,83
60				4,71	5,47	6,99	10,94
70				5,44	6,19	8,14	13,22
80						9,56	15,34
90						11,30	16,74
100						14,64	19,97
110							24,76
120							25,82
130							27,44
140							28,99
150							31,82



Medidas abrangidas pela certificação.

**PARAFUSOS CABEÇA CHATA PZD
PARA AGLOMERADO DE MADEIRA**



• ACABAMENTO LATONADO/ OXIDADO

DIÂMETRO	2,5	3	3,5	4	4,5	5	6
COMPRIM. (mm)							
12	1,01	0,94	1,06				
16	1,03	0,95	1,15	1,43	1,80		
18	1,20	1,06	1,21	1,54	1,93		
20	1,21	1,07	1,26	1,51	2,05	2,83	
25		1,21	1,48	1,74	2,33	2,89	
30		1,43	1,67	1,98	2,62	3,17	
35			1,96	2,20	3,06	3,73	
40			2,20	2,41	3,46	3,78	6,05
45				2,75	3,61	4,21	6,77
50				3,10	4,00	4,61	7,36
60				4,08	5,27	5,45	8,52
70						6,58	10,18
80						8,29	11,71

**PARAFUSOS CABEÇA CHATA TORX
PARA AGLOMERADO DE MADEIRA**



• AÇO ZINCADO BRANCO • AÇO ZINCADO AMARELO

DIÂMETRO	2,5	3	3,5	4	4,5	5	6
COMPRIM. (mm)	TX 8	TX 10	TX 15	TX 20	TX 20	TX 25	TX 30
12	0,76	0,66	0,82				
16	0,77	0,67	0,85	1,06	1,34	2,05	
18	0,89	0,76	0,97	1,17	1,53	2,08	
20	0,92	0,77	0,99	1,19	1,55	2,13	
25		0,92	1,14	1,39	1,78	2,18	
30		1,06	1,31	1,59	2,08	2,59	
35		1,34	1,49	1,85	2,43	2,97	
40		1,53	1,74	2,03	2,73	3,27	5,45
45		1,91	1,91	2,36	2,97	3,66	5,64
50		2,10	2,10	2,57	3,27	4,00	5,84
55				3,09	3,86	4,55	6,83
60				3,24	3,96	4,73	6,93
70				3,92	4,76	5,43	8,02
80						6,14	9,11
90						7,33	10,48
100						8,51	12,37
110							14,06
120							15,64
130							18,61
140							19,70
150							22,99

**PARAFUSOS CABEÇA CHATA TORX
PARA AGLOMERADO DE MADEIRA**



• AÇO INOX-A2

DIÂMETRO	2,5	3	3,5	4	4,5	5	6
COMPRIM. (mm)	TX 8	TX 10	TX 15	TX 20	TX 20	TX 25	TX 30
12	2,66	1,67	2,66				
16	2,69	1,94	2,17	2,80	3,68	4,84	
18	3,25	2,16	2,42	3,07	4,06	4,84	
20	3,25	2,16	2,42	3,07	4,06	4,96	
25		2,42	2,80	3,56	4,58	5,66	
30		2,66	3,20	4,14	5,13	6,37	
35		3,09	3,72	4,59	5,79	7,07	
40		3,40	4,10	5,06	6,27	7,84	12,30
45		3,94	4,52	5,51	6,87	8,52	13,32
50		4,28	4,90	6,06	7,35	9,19	14,40
55				7,14	8,36	10,58	16,72
60				7,28	8,43	10,78	16,90
70				8,41	9,55	12,57	20,40
80						14,74	23,65
90						17,42	25,85
100						22,58	30,83
110							38,21
120							39,84
130							42,33
140							44,75
150							49,10



Medidas abrangidas pela certificação.

PARAFUSOS CABEÇA DE QUEIJO PZD PARA AGLOMERADO DE MADEIRA



• AÇO ZINCADO BRANCO • AÇO ZINCADO AMARELO

DIÂMETRO	2,5	3	3,5	4	4,5	5	6
COMPRIM. (mm)	PZ 1	PZ 1	PZ 2	PZ 2	PZ 2	PZ 2	PZ 3
12	1,04	1,04	1,25				
16	1,09	1,09	1,35	1,58	1,94	2,94	
20	1,15	1,15	1,50	1,73	2,04	2,94	
25		1,25	1,58	2,04	2,48	3,16	
30		1,58	1,79	2,27	2,94	3,42	
35		2,04	2,04	2,40	3,16	3,84	
40		2,27	2,27	2,59	3,61	4,07	6,77
45		2,48	2,48	2,94	3,84	4,30	7,23
50		2,73	2,73	3,16	4,07	4,99	7,92
60				4,07	5,66	5,88	9,03
70					7,23	7,23	10,19
80						7,92	11,29
90							13,52
100							15,79

PARAFUSOS CABEÇA DE QUEIJO PZD PARA AGLOMERADO DE MADEIRA



• AÇO INOX-A2

DIÂMETRO	2,5	3	3,5	4	4,5	5	6
COMPRIM. (mm)	PZ 1	PZ 1	PZ 2	PZ 2	PZ 2	PZ 2	PZ 3
12	2,36	2,36	2,83				
16	2,68	2,68	2,83	4,02	5,24	7,15	
20		2,88	3,26	4,25	5,24	7,15	
25		3,16	3,89	4,48	5,76	7,40	
30		3,59	4,44	5,40	6,96	8,36	
35		3,89	4,76	6,00	7,57	8,92	
40		4,25	5,33	6,35	8,21	9,92	17,59
45		4,39	6,06	6,60	9,06	11,14	17,77
50		5,40	6,62	8,34	9,62	11,59	18,14
60				9,16	11,90	13,58	21,58
70						15,84	26,08
80						17,74	29,81
90							32,53
100							37,63



Medidas abrangidas pela certificação.

PARAFUSOS CABEÇA CHATA PZD PARA AGLOMERADO DE MADEIRA COM FURO PARA TAMPA

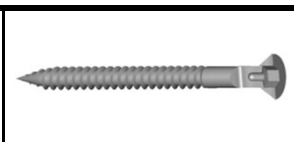

• AÇO ZINCADO BRANCO

DIÂMETRO	4	4,5	5	6
COMPRIM. (mm)				
30		3,58		
35		3,94		
40		4,30	4,30	
45		4,66	4,66	
50		5,01	5,01	
60		7,18	9,31	
70			10,75	

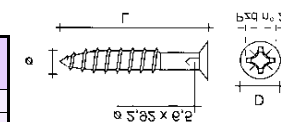

TAMPA

CORES: Branco, bege, cinza, castanho claro e escuro, preto.

PREÇO 1,00

PARAFUSOS PARA PUXADORES



• AÇO ZINCADO BRANCO

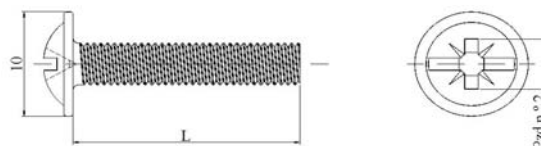

COMPRIMENTO (mm)	8	10	12	16	18	20	22	25	28	30	35	40	45	50	55	60	65	70
M-4	1,14	1,14	1,21	1,34	1,41	1,48	1,55	1,64	1,78	1,90	2,24	2,50	2,75	2,95				

TURBOSHARP - POZIDRIV
PARAFUSOS DE ALTO RENDIMENTO
PARA MADEIRAS DURAS



**TURBOSHARP
POZIDRIV**



Revestimento
Sintético
- efeito sabão -



A Fenda POZIDRIV.

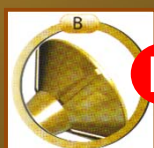

B Nervuras fresantes para um embeber perfeito mesmo nas madeiras mais duras.



C Cabeça reforçada.



D Rosca de passo largo para aplicação mais rápida. Revestimento sintético - efeito sabão.



E Rosca serrilhada - diminui o esforço de aparafusar e evita o estalar da madeira.



F Zona de broca auto-roscante para facilitar o avanço.



G Ponta de broca afiada - elimina a necessidade de furar previamente.

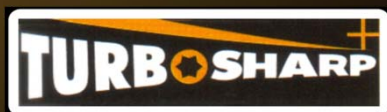

DIMENSÕES	TURBOSHARP - POZIDRIV						
	• AÇO ZINCADO BRANCO / AMARELO						
Ø	2,5	3	3,5	4	4,5	5	6
L (mm)							
12	0,87	0,91	1,00				
16	1,00	1,03	1,18	1,47			
20		1,56	1,63	1,89	2,28	2,56	
25		1,70	1,81	2,12	2,59	3,03	
30		2,00	2,08	2,44	3,03	3,56	
35		2,16	2,28	2,74	3,34	3,97	
40		2,33	2,48	2,96	3,72	4,37	6,08
45			2,72	3,21	3,98	4,78	6,55
50			2,96	3,54	4,34	5,24	7,36
55				4,63	5,69		
60				5,15	6,21	6,29	8,75
70				5,90	7,11	6,99	9,89
80						8,18	11,54
90						11,95	13,44
100						13,10	14,85
110							17,25
120							19,41
130							28,11
140							31,03
150							35,49
160							37,00
180							52,94
200							62,08
220							
240							
260							
280							
300							

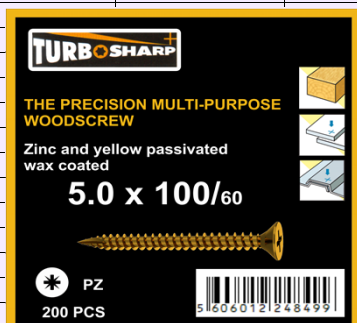

TURBOSHARP - TORX
PARAFUSOS DE ALTO RENDIMENTO
PARA MADEIRAS DURAS



**TURBOSHARP
TORX**



TORX



A

Fenda TORX. Melhor transmissão. Sem deslizos. Com marcação do tamanho.

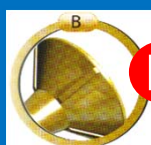

B

Nervuras fresantes para um embeber perfeito mesmo nas madeiras mais duras.



C

Cabeça reforçada.

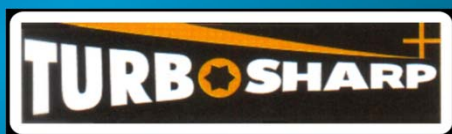

Revestimento Sintético - efeito sabão -



D

Rosca de passo largo para aplicação mais rápida. Revestimento sintético - efeito sabão.



E

Rosca serrilhada - diminui o esforço de aparafusar e evita o estalar da madeira.

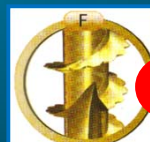

F

Zona de broca auto-roscante para facilitar o avanço.



G

Ponta de broca afiada - elimina a necessidade de furar previamente.

DIMENSÕES	TURBOSHARP - TORX						
	• AÇO ZINCADO BRANCO / AMARELO						
Ø	2,5	3	3,5	4	4,5	5	6
L (mm)							
12		0,91	1,00				
16		1,03	1,18	1,47			
20		1,56	1,63	1,89	2,28	2,56	
25		1,70	1,81	2,12	2,59	3,03	
30		2,00	2,08	2,44	3,03	3,56	
35		2,16	2,28	2,74	3,34	3,97	
40		2,33	2,48	2,96	3,72	4,37	6,08
45			2,72	3,21	3,98	4,78	6,55
50			2,96	3,54	4,34	5,24	7,36
55				4,63	5,69		
60				5,15	6,21	6,29	8,75
70				5,90	7,11	6,99	9,89
80						8,18	11,54
90						11,95	13,44
100						13,10	14,85
110							17,25
120							19,41
130							28,11
140							31,03
150							35,49
160							37,00
180							52,94
200							62,08
220							
240							
260							
280							
300							



LOGLOK
PARAFUSOS DE ALTO RENDIMENTO
PARA MADEIRAS DURAS



**LOGLOK
TORX**



A Fenda TORX. Melhor transmissão. Sem desliz. Com marcação do tamanho.



B Cabeça reforçada e nervuras fresantes para um embeber perfeito mesmo nas madeiras mais duras.



C Estrias após a rosca para limpar o furo. Permite uma óptima união entre placas.



D₁ Rosca de passo largo para aplicação mais rápida. Revestimento sintético - efeito sabão.



D₂ Rosca serrilhada - diminui o esforço de aparafusar e evita o estalar da madeira.



E Zona de broca auto-roscante para facilitar o avanço.



F Ponta de broca afiada- elimina a necessidade de furar previamente.

Revestimento Sintético - efeito sabão -



DIMENSÕES	LOGLOK - TORX							
	• AÇO ZINCADO AMARELO							
Ø	4	4,5	5	6	8	10	12	14
L (mm)								
40								
45								
50								
55								
60								
70								
80				14,40	27,60			
90				15,60	32,40			
100				16,80	36,00			
110				21,60	39,60			
120				24,00	43,20	76,80		
130				27,60	48,00	84,00		
140				30,00	50,40	90,00	142,80	
150				33,60	54,00	97,20	151,20	
160				34,80	60,00	106,80	163,20	
180				44,40	67,20	120,00	189,60	
200				56,40	79,20	132,00	210,00	
220					88,80	150,00	237,60	
240					104,40	165,60		
260					117,60	199,20	318,00	
280					133,20	235,20		
300					145,20	250,80	402,00	
320					158,40	284,40		
360					176,40	307,20	493,20	
400					194,40	322,80	546,00	
420						364,80		
460						430,80	697,20	
500							756,00	



PARAFUSOS AUTOPERFURANTES CABEÇA CHATA REFORÇADA - TORX PARA MADEIRAS DURAS



• AÇO ZINCADO BRANCO

CARACTERÍSTICAS:

- **Ponta de broca** - facilita a penetração no material. Evita o estalar da madeira nas aplicações junto aos bordos;
- **Cabeça reforçada** - maior resistência dos parafusos nas aplicações em madeiras duras;
- **Nervuras fresantes** - sob a cabeça estão dispostas 6 nervuras fresantes para limpeza das rebarbas do furo e um embeber perfeito da cabeça;
- **Fenda TORX** - melhor transmissão do binário de aperto sem deslizamentos.

*Especial para aplicações
junto aos bordos*

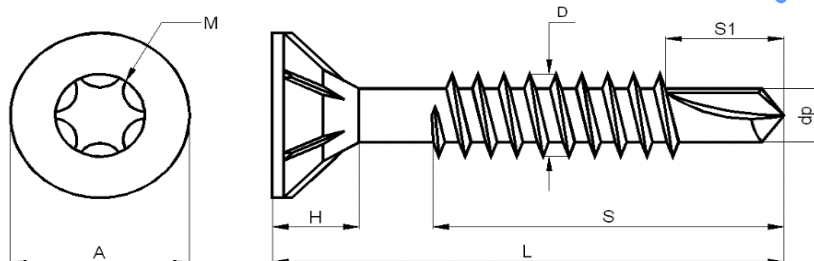

MEDIDAS	L	S	H	D	dp	S1	A	M
Ø								
M 3,5	45	28	3,60	3,25	2,50	3,90	7	TX 15
	50	36						
M 4,0	40	28	4,25	3,75	2,85	4,10	8	TX 20
	45	28						
	50	36						
M 4,5	45	28	4,60	4,25	3,20	4,30	9	TX 20
	50	36						

Dimensões em mm

DIÂMETRO	2,5	3	3,5	4	4,5	5	6
COMPRIM. (mm)							
30							
35							
40				2,00			
45			2,00	2,40	2,88		
50			2,40	2,56	3,12		
60				3,20			
70							

HASTES ROSCADAS COM 2 ROSCAS



HASTES ROSCADAS COM 2 ROSCAS

• ZINCADO



COMPRIM. (mm)	M-6	M8
35		
40	8,51	13,34
50	9,00	14,18
60	10,84	16,01
70	12,51	19,01
80	14,18	21,52

HASTES ROSCADAS COM DUAS ROSCAS DE MADEIRA

• ZINCADO AMARELO



COMPRIM. (mm)	Ø 6,6		
70	14,38		

HASTES ROSCADAS COM DUAS ROSCAS (ROSCA DE MADEIRA + ROSCA MÉTRICA) HEXAGONAL AO MEIO + TORX

• ZINCADO BRANCO

• INOX-A2



M8x80	22,30	M10x80	27,29	M-8x50	54,60
M8x90	22,81	M10x90	30,00	M-8x80	72,07
M8x100	23,47	M10x100	33,97	M-8x110	98,28
M8x110	22,30	M10x110	37,00		
M8x120	29,33	M10x120	41,06		
M8x130	31,99	M10x130	45,00		
M8x140	34,10	M10x140	51,00		
		M10x150	57,00		

PARAFUSOS DE MONTAGEM COM SEXTAVADO INTERIOR



• ZINCADO BRANCO



COMPRIM. (mm)	Ø 5	Ø 7	TAMPAS
40	5,38	7,25	castanho
50	5,75	7,63	branco
60		10,13	preto
70		12,25	1,25

PORCAS DE BUSSOLA (SEM-FIM)



• ZINCADO BRANCO Cr3

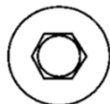
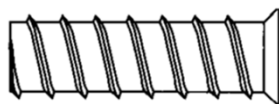

COMPRIM. (mm)	M-4	M-6	M-8	M-10
10	6,71			
13		6,24		
15		6,71	8,74	
20		7,80	10,30	14,98
24			11,70	

CABEÇAS PARA HASTES FENDADAS OU COM SEXTAVADO INTERIOR

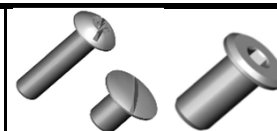

• LATONADO • NIQUELADO • OXIDADO

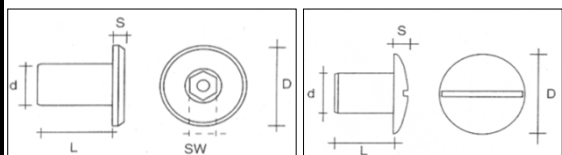

FORMA	MEDIDA	L	D	d	S	SW	PREÇO
	M6	12	15	8	3,5	Pzd 3	9,12
	M8	14	20	10	3	-	13,75
	M6	12	15	8	2	4	7,92
	M8	16	19	10	2,5	5	13,75

PARAFUSOS DE LIGAÇÃO COM SEXTAVADO INTERIOR



• **NIQUELADO**

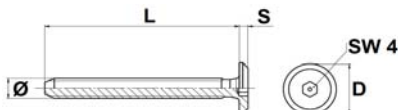

D = 15
S = 2,5
Ø = M-6

ACABAMENTO	Ø	COMPRIMENTO L											
		15	20	25	30	35	40	50	60	70	80	90	100
NIQUELADO	M-6	9,06	9,31	10,10	10,88	11,64	12,43	14,75	17,60	20,18	23,29	25,11	27,69

ESCÁPULA COM RANHURA



• **ZINCADO BRANCO**



COMPRIM. (mm)	Ø 6,3		
54	15,53		

CAVILHA PARA SOALHOS



• **AÇO ZINCADO AMARELO**

APLICAÇÕES E CARACTERÍSTICAS:

- É ideal para a fixação de ripas no chão ou nas paredes e para a colocação de frisos;
- É ideal para uma instalação rápida;
- É cavilha e prego num só;
- Utiliza-se sobre materiais consistentes como betão, tijoleira maciça, etc.

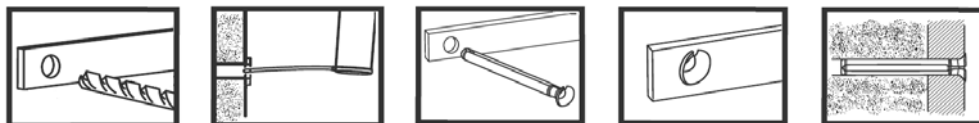

medidas em mm

DIÂMETRO	COMPRIMENTO	PROFUNDIDADE FIXAÇÃO (MÍN.)	DIÂMETRO DO FURO	ESPESS. MÍNIMA MATERIAL BASE	ESPESS. MÁXIMA MATERIAL A FIXAR		PREÇO
6	30	27	6	32	3	200	9,72
	50	30		35	20	200	10,91
	60	30		35	30	200	11,81
	80	30		35	50	200	14,20
8	70	40	8	45	30	100	23,92
	90	40		45	50	100	26,91
	110	40		45	70	100	29,90
	130	40		45	90	100	32,89
	150	40		45	110	100	37,38

PITÕES, CAMARÕES, ESCÁPULAS E OUTROS ACESSÓRIOS



PRODUTO	MEDIDA	DIMENSÕES					REF ^a	PREÇO	
		A	B	C	D			LAT. POL	ZINCADO
PITÕES ROSCA MÉTRICA 	M4 x 40	3,45	6,0	53,0	39,0	1000	1334053		5,81
	M5 x 50	4,4	8,0	67,0	48,0	500	1344067		9,69
	M6 x 85	5,25	10,0	105,0	56,0	125	1352105		22,94
	M8 x 100	7,0	12,0	125,0	80,0	100	1370125		45,88
	M10 x 100	8,8	14,0	129,0	80,0	50	1388129		72,17

PRODUTO	MEDIDA	DIMENSÕES					REF ^a	PREÇO	
		A	B	C	D			LAT. POL	ZINCADO
CAMARÕES ROSCA MÉTRICA 	M4 x 50	3,45	16,0	51,0	20,0	500	3034051		8,05
	M5 x 67	4,40	8,0	67,0	48,0	500	3044067		11,88
	M6 x 80	5,25	10,0	79,0	50,0	250	3052079		19,54
	M8 x 105	7,0	12,0	105,0	75,0	100	3070105		51,92
	M10 x 130	8,8	14,0	129,0	78,0	50	3088129		85,95

PRODUTO	MEDIDA	DIMENSÕES					REF ^a	PREÇO		
		A	B	C	D			LAT. POL	ZINCADO	
PITÕES ROSCA DE MADEIRA 	1.8 x 18	1,85	5,0	18,0	7,0	5000	1018018		1,41	
	1.8 x 21	1,85	6,4	21,0	7,0	5000	1018021		1,52	
	1.8 x 24	1,85	6,4	24,0	8,0	5000	1018024		1,56	
	2.0 x 16	2,0	4,0	16,0	6,0	5000	1020016		6,35	1,32
	2.0 x 20	2,0	6,0	20,0	8,0	5000	1020020			1,59
	2.0 x 23	2,0	7,0	23,0	8,0	5000	1020023			1,67
	2.2 x 20	2,2	4,0	20,5	8,0	2500	1022#20		7,94	1,53
	2.2 x 24	2,2	8,0	24,0	10,0	2500	1022024			1,92
	2.5 x 24	2,5	5,0	24,0	10,0	2500	1025024			2,28
	2.5 x 28	2,5	8,0	28,0	10,0	2500	102528			2,58
	2.5 x 30	2,5	10,0	30,0	10,0	2500	1025030			2,82
	2.7 x 25	2,7	8,0	25,0	6,0	1000	1027025		14,63	2,28
	3.0 x 25	3,0	7,0	25,0	8,0	1000	1030025			3,02
	3.0 x 30	3,0	9,0	30,0	12,0	1000	1030030		20,95	3,15
	3.0 x 34	3,0	10,0	34,0	12,0	1000	1030034		22,82	3,39
	3.0 x 40	3,0	9,0	40,2	15,0	1000	1030040			4,08
	3.3 x 30	3,3	6,0	30,0	15,0	1000	1033030			4,16
	3.3 x 37	3,3	10,0	37,0	12,0	1000	1033037			4,94
	3.3 x 45	3,3	15,0	45,0	15,0	1000	1033045			5,88
	3.7 x 39	3,7	12,0	39,0	16,0	500	1037039		39,37	5,73
	3.7 x 50	3,7	16,0	50,0	19,0	500	1037050			7,58
	4.0 x 30	4,0	7,0	30,0	16,0	500	1040030			5,54
	4.0 x 35	4,0	7,0	35,0	16,0	500	1040035			6,06
	4.0 x 41	4,0	12,0	41,0	16,0	500	1040041			6,74
	4.0 x 45	4,0	12,0	45,0	16,0	500	1040045			7,76
	4.0 x 51	4,0	12,0	51,0	16,0	500	1040051			7,23
	4.0 x 62	4,0	14,0	62,0	25,0	500	1040062			8,49
	4.85 x 53	4,85	14,0	53,9	19,0	250	1048*53			11,55
	4.85 x 63	4,85	14,0	63,9	25,0	250	1048*63			12,86
	4.85 x 73	4,85	14,0	73,9	32,0	250	1048*73			13,91
	4.85 x 76	4,85	14,0	76,0	32,0	200	1148076			16,67
	4.85 x 95	4,85	14,0	95,0	32,0	200	1148095			18,99
	4.85 x 115	4,85	14,0	115,0	32,0	200	1148115			21,23
4.85 x 127	4,85	14,0	127,0	51,0	200	1148127			22,88	
6.3 x 83	6,3	16,0	83,0	38,0	100	1163083			30,39	
6.3 x 102	6,3	16,0	102,0	51,0	100	1163102			34,29	
6.3 x 152	6,3	16,0	152,0	51,0	100	1163152			47,58	
7.6 x 102	7,6	19,0	102,0	51,0	50	1176102			56,55	
7.6 x 115	7,6	19,0	115,0	51,0	50	1176115			61,14	
7.6 x 152	7,6	19,0	152,0	51,0	50	1176152			67,73	
7.6 x 203	7,6	19,0	203,0	76,0	50	1176203			83,45	

PITÕES, CAMARÕES, ESCÁPULAS E OUTROS ACESSÓRIOS

? 7

PRODUTO	MEDIDA	DIMENSÕES					REF ^a	PREÇO	
		A	B	C	D			LAT. POL	ZINCADO
CAMARÕES ROSCA DE MADEIRA	2.2 x 20	2,2	6,0	20,0	6,0	5000	1622020	7,94	1,58
	2.5 x 25	2,5	8,0	25,0	8,0	1000	1625025	11,32	2,02
	2.7 x 28	2,7	10,0	28,0	10,0	1000	1627028		2,43
	3.0 x 30	3,0	11,0	30,0	10,0	1000	1630030	18,29	3,14
	3.0 x 35	3,0	12,0	35,0	12,0	1000	1630035	21,31	3,46
	3.0 x 39	3,0	15,0	39,0	12,0	1000	1630039	24,19	3,82
	3.0 x 45	3,0	12,0	45,0	12,0	1000	1630045		4,13
	3.3 X 39	3,3	12,0	39,4	15,0	500	1633*39		5,02
	3.3 X 45	3,3	19,0	45,0	16,0	500	1633045		5,95
	3.3 x 51	3,3	19,0	51,0	19,0	500	1633051	37,48	5,94
	3.3 X 60	3,3	16,0	60,0	19,0	500	1633060		6,51
	3.7 X 51	3,7	17,0	51,0	19,0	500	1637051		7,63
	3.7 X 55	3,7	17,0	55,0	19,0	500	1637*55		8,18
	3.7 X 60	3,7	17,0	60,3	19,0	500	1637*60		8,48
	4.0 X 55	4,0	18,0	55,0	19,0	500	1640055		9,23
	4.0 x 60	4,0	18,0	60,0	19,0	500	1640060	58,21	8,75
	4.3 X 51	4,3	19,0	51,0	19,0	250	1643051		10,30
	4.3 x 63	4,3	20,0	63,4	19,0	250	1643*63		10,61
	4.3 x 90	4,3	20,0	90,0	25,0	250	1643090		14,29
	4.85 x 51	4,85	11,0	51,0	25,0	250	1648051		11,28
	4.85 x 60	4,85	16,4	60,0	19,0	250	1648060		13,76
	4.85 x 69	4,85	16,0	69,0	32,0	250	1648069		14,38
	4.85 x 80	4,85	20,0	80,0	32,0	250	1648080		18,42
	4.85 x 90	4,85	22,0	90,0	32,0	250	1648090		26,78
	6.0 x 78	6,0	26,0	78,0	32,0	125	1660*78		34,08
	6.0 x 88	6,0	26,0	88,3	32,0	125	1660*88		31,97
	6.3 x 102	6,3	26,0	102,0	32,0	125	1663102		38,70
	6.3 x 114	6,3	26,0	114,0	38,0	125	1663114		44,78
	6.3 x 125	6,3	26,0	125,0	38,0	125	1663125		47,01
	6.3 x 152	6,3	26,0	152,0	38,0	125	1663152		53,20
7.6 x 152	7,6	26,0	152,0	51,0	100	1676152		76,48	
7.6 x 175	7,6	26,0	175,0	51,0	100	1676175		85,06	
7.6 x 203	7,6	26,0	203,0	51,0	100	1676203		91,39	

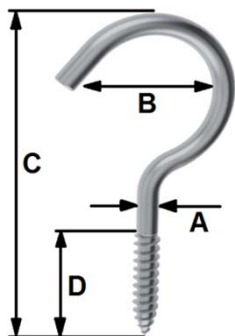

PRODUTO	MEDIDA	DIMENSÕES					REF ^a	PREÇO	
		A	B	C	D			LAT. POL	ZINCADO
ESCÁPULAS ROSCA DE MADEIRA	2.0 x 20	2,0	8,0	20,0	8,0	5000	0420020	6,41	1,31
	2.0 x 25	2,0	8,0	25,0	10,0	5000	0420025	7,43	1,43
	2.5 x 30	2,5	10,0	30,0	10,0	2500	0425030	11,56	1,92
	2.5 X 35	2,5	10,0	35,0	10,0	2500	0425035		2,46
	3.0 x 30	3,0	10,0	30,0	12,0	2000	0430030	15,43	2,55
	3.0 X 35	3,0	10,2	35,0	15,0	2000	0430*35		3,35
	3.0 x 40	3,0	12,0	40,0	15,0	1000	0430040	19,76	3,06
	3.3 X 35	3,3	12,3	35,0	15,0	1000	0433*35		3,59
	3.3 X 40	3,3	12,0	40,0	15,0	1000	0433040		4,07
	3.3 X 46	3,3	14,0	46,0	15,0	1000	0433046		4,46
	3.3 X 51	3,3	14,0	51,0	19,0	1000	0433051		4,71
	3.7 X 40	3,7	13,3	40,0	19,0	500	0437*40		4,95
	3.7 X 45	3,7	13,3	45,0	19,0	500	0437*45		5,36
	3.7 X 50	3,7	13,3	50,0	19,0	500	0437*50		5,69
	4.0 x 40	4,0	14,0	40,0	16,0	500	0440040		5,16
	4.0 x 45	4,0	14,0	45,0	16,0	500	0440045		5,52
	4.0 x 51	4,0	14,0	51,0	19,0	500	0440051	41,62	6,00
	4.0 x 60	4,0	14,0	60,0	22,0	500	0440060		6,96
	4.3 X 50	4,3	14,3	50,0	19,0	500	0443*50		8,43
	4.3 X 60	4,3	14,3	60,0	21,0	500	0443*60		9,32
	4.3 X 70	4,3	18,0	70,0	32,0	500	0443070		10,56
	4.3 x 80	4,3	18,0	80,0	32,0	250	0443080		10,58
	4.85 X 50	4,85	18,0	50,0	25,0	200	0448050		10,86
	4.85 X 60	4,85	18,0	60,0	25,0	200	0448060		12,08
	4.85 X 70	4,85	17,4	70,0	25,0	200	0448*70		13,16
	4.85 X 80	4,85	18,0	80,0	25,0	100	0448080		14,30
	4.85 X 102	4,85	18,0	102,0	38,0	100	0448102		17,48
	6.0 X 60	6,0	21,0	60,0	25,0	100	0460060		17,55
	6.0 X 70	6,0	20,0	70,0	25,0	100	0460070		18,80
	6.0 X 80	6,0	20,0	80,0	32,0	100	0460*80		20,57
6.0 X 100	6,0	20,0	100,0	32,0	100	0460A00		29,30	

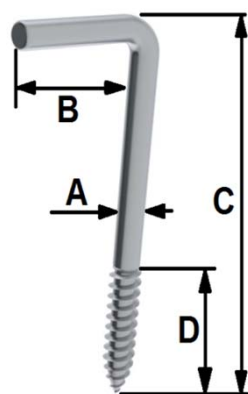

PITÕES, CAMARÕES, ESCÁPULAS E OUTROS ACESSÓRIOS



PRODUTO	MEDIDA	DIMENSÕES							REF ^a	PREÇO	
		A	C	C1	D	F1	F2			LAT. POL	ZINCADO
ESCÁPULA COM RANHURA ROSCA DE MADEIRA 	3.4 x 48	3,4	48,0	40,0	33,0	0,8	1,2	1000	3634048		14,47
	4.4 x 65	4,4	65,0	55,0	49,0	1,2	1,2	500	3644065		18,36
	4.9 x 70	4,9	70,0	55,0	47,0	1,4	1,2	250	3649070		22,03
	5.9 x 77	5,9	77,0	65,0	51,0	1,7	1,2	250	3659077		30,10

PRODUTO	MEDIDA	DIMENSÕES					REF ^a	PREÇO	
		A	C	G	PITÃO			LATÃO	ZINCADO
ALDRABAS ROSCA DE MADEIRA 	1 1/4"	3,0	31,0	17,3	2.5 x 20	500	0830031	33,44	11,18
	1 1/2"	3,0	38,0	16,0	2.5 x 20	500	0830038	35,60	11,61
	2"	3,3	49,0	18,0	3.0 x 25	500	0833051	56,75	15,25
	2 1/2"	3,5	62,0	21,0	3.0 x 25	250	0835064	64,62	18,16
	3"	3,9	76,0	24,0	3.3 x 30	250	0839076		20,20
	4"	4,0	102,0	23,0	3.3 x 30	200	0840102		28,39

PRODUTO	MEDIDA	DIMENSÕES					REF ^a	PREÇO	
		A	B	C	D			LATÃO	ZINCADO
CAMARÃO E PITÃO PARA CABO DE CORTINADOS ROSCA DE MADEIRA 	2.0 x 28	2,0	5,0	28,0	8,0	2500	1620028		1,82
PITÃO 	2.0 x 18	2,0	6,4	18,0	7,0	5000	1020018		1,20

PRODUTO	MEDIDA	DIMENSÕES			REF ^a	PREÇO	
			PREGO			LATON.	ZINCADO
GANCHOS PARA QUADROS 	# 0		1,5 x 1"	5000	8100010	7,16	
	# 2		1,5 x 1"	1000	8100025	7,96	
	# 3		1,5 x 1"	1000	8100040	11,18	
	# 4		1,5 x 1"	500	8100060	14,85	

PRODUTO	MEDIDA	DIMENSÕES					REF ^a	PREÇO	
		A	B	C	D			LATON.	ZINCADO
TRIÂNGULO PARA QUADROS 	0.65 x 19,6	1,1	10,1	19,8	9,6	5000	4811020	9,83	
					12			10,37	
					16			11,09	

PRODUTO	MEDIDA	DIMENSÕES					REF ^a	PREÇO	
GANCHOS PLÁSTICOS 	3 pregos					1000	4930030	14,54	
	4 pregos					1000	4940040	17,91	

PORCAS SEXTAVADAS DIN 934



- AÇO CLASSE 8 - PRETO, ZINCADO BRANCO, GALVANIZADO A QUENTE
- AÇO CLASSE 10 - PRETO, ZINCADO
- AÇO INOX-A2, A4



ROSCA MÉTRICA PORCAS SEXTAVADAS DIN 934

Ø	AÇO CLASSE 8			CLASSE 8 CERTIFICADA		AÇO CLASSE 10		AÇO INOX	
	PRETO	ZINC. BR.	GALVANIZ. A QUENTE	PRETO	ZINCADO	PRETO	ZINCADO	A2	A4
M-3	0,19	0,21						0,73	1,39
M-4	0,23	0,29						1,10	2,07
M-5	0,33	0,34						1,00	2,13
M-6	0,55	0,56		0,73	0,75	0,80	0,86	1,62	3,45
M-8	1,07	1,13	1,87	1,55	1,60	1,60	1,68	3,27	6,94
M-10	2,35	2,48	4,16	3,42	3,52	3,49	3,70	7,18	15,25
M-12	3,49	3,72	6,18	5,03	5,19	5,20	5,55	10,55	22,40
M-14	5,46	5,83	9,73	7,43	7,66	8,18	8,71	16,16	34,31
M-16	6,96	7,40	12,37	9,99	10,30	10,42	11,07	20,37	43,24
M-18	10,60	11,28	18,80	14,66	15,11	15,84	16,84	32,28	68,57
M-20	14,15	15,06	25,15	19,32	19,92	21,19	22,56	39,53	83,96
M-22	18,96	20,17	38,72	24,23	24,98	32,67	34,71	68,76	131,44
M-24	26,09	27,76	53,28	35,54	36,64	44,91	47,76	86,68	165,74
M-27	52,47	54,09	91,59	52,47	54,09	77,18	82,12	164,40	314,33
M-30	71,24	73,44	123,79	71,24	73,44	104,35	111,01	254,08	485,78
M-33	120,71	124,44	173,21	120,71	124,44	145,98	155,29	412,52	788,66
M-36	162,62	167,65	236,35	162,62	167,65	199,19	211,90	472,28	902,96
M-39	205,74	212,10		205,74	212,10	254,44	270,68	747,30	1 428,75
M-42	267,02	275,46		267,02	275,46	330,50	351,58	926,64	1 771,68
M-45	348,71	359,50		348,71	359,50	405,49	431,36	1 105,99	2 265,60
M-48	427,17	440,38		427,17	440,38	495,19	526,82	1 285,35	2 633,01
M-52	530,44	546,85		530,44	546,85	618,36	657,80	1 434,80	2 939,13
M-56	657,18	677,51		657,18	677,51	719,70	765,67		
M-60	793,31	817,85		793,31	817,85				

PORCAS DE MAMA DIN 1587



- AÇO INOX-A2, A4



Ø	AÇO INOX	
	A2	A4
M-3	4,39	9,59
M-4	4,39	8,11
M-5	4,39	8,85
M-6	5,60	11,80
M-8	10,40	19,16
M-10	22,38	36,86
M-12	33,58	58,99
M-14	95,93	
M-16	95,93	184,31
M-18		
M-20	279,80	516,06

PORCAS



• DIN 985 • DIN 980 V • DIN 6923 • DIN 936 • DIN 929 • DIN 928 • DE ORELHAS • DE GARRA

P O R C A S	PORCAS AUTOBLOCANTES			PORCAS C/ FLANGE		PORCAS BAIXAS	PORCAS DE SOLDAR SEXTAVADA	PORCAS DE SOLDAR QUADRADA	PORCAS DE ORELHAS		PORCAS DE GARRA	
	DIN 985		DIN 980 V	DIN 6923		DIN 936	DIN 929	DIN 928	MODELO AMERICANO			
Ø	CL 8 ZINCADO	AÇO INOX A2	AÇO INOX A4	CL 8 ZINCADO	CL 8 ZINCADO	AÇO INOX A2	CL 8 ZINCADO	CL 8 PRETO	CL 8 PRETO	CL 6 ZINCADO Cr3	AÇO INOX A2	ZINCADO Cr3
M-3	0,62	1,35				2,86				6,12	16,72	
M-4	0,62	1,59	5,15		0,73	2,96	0,38			6,38	17,07	2,91
M-5	0,75	1,75	5,48		0,86	3,57	0,44	1,31		6,38	19,50	2,91
M-6	0,75	2,43	4,96	2,45	0,98	4,04	0,55	1,48	1,54	8,06	29,26	3,61
M-8	1,53	5,17	10,18	4,03	2,02	7,29	1,22	2,78	3,38	10,49	36,57	4,51
M-10	3,39	12,08	21,84	8,73	4,07	12,65	2,42	5,03	5,91	17,53	58,51	7,51
M-12	4,99	18,77	32,58	12,43	5,55	26,31	3,59	7,21	8,52	46,15	121,90	
M-14	8,30	42,27	67,37	19,67	8,39		5,71					
M-16	10,26	46,29	70,41	25,54	12,99		6,42			138,05	292,55	
M-18	17,99	201,24	248,48				10,02					
M-20	20,37	234,77	263,13				12,02			199,97		
M-22	28,48	402,45					20,02					
M-24	43,68	503,08					28,05					
M-27	82,07						40,06					
M-30	102,59						52,07					
M-33	212,18											
M-36	293,69											
M-39	372,36											
M-42	434,42											
M-45	558,54											

UNIÕES SEXTAVADAS





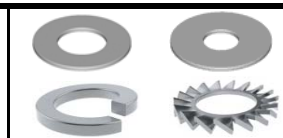

• ZINCADO • INOX A2

	MEDIDA DxSxL	ZINCADO	INOX A2
	M-5x8x20	100	5,95
M-6x10x25	100	6,53	100 66,70
M-8x13x25	100	9,74	100 95,45
M-10x17x30	50	20,58	50 189,75
M-12x19x30	50	24,09	50 253,00
M-14x22x42	25	59,54	
M-16x24x50	10	67,87	
M-18x27x54	10	123,88	
M-20x30x60	10	162,38	
M-22x32x66	10	216,50	
M-24x36x72	10	405,92	
M-30x46x90	5	811,82	
M-36x55x108	5	1 353,10	

ANILHAS







• DIN 125-A • DIN 9021 • DIN 127-B • DIN 6798-A

ANILHAS	ANILHAS PLANAS				ANILHAS DE ABA LARGA				ANILHAS DE MOLA				ANILHAS RECARTILHADAS		
	DIN 125-A				DIN 9021				DIN 127-B				DIN 6798-A		
													 		
Ø	ZINCADO	GALVAN. HDG	INOX-A2	INOX-A4	ZINCADO	GALVAN. HDG	INOX-A2	INOX-A4	PRETO	ZINCADO	INOX-A2	INOX-A4	PRETO	ZINCADO	INOX-A2
M-3	0,10		0,32	0,64	0,27		0,67	1,50	0,21	0,23	0,34	0,68	0,43	0,56	
M-4	0,15		0,40	0,74	0,48		0,71	1,58	0,23	0,25	0,34	0,68	0,49	0,64	1,54
M-5	0,21		0,49	1,02	0,79		1,20	2,33	0,32	0,36	0,44	0,71	0,58	0,75	2,42
M-6	0,45		0,90	2,17	1,11		2,05	4,12	0,59	0,65	0,77	1,60	0,77	1,00	2,86
M-8	0,76	1,58	1,34	2,62	2,47	5,00	4,58	9,92	0,91	0,99	1,44	2,93	1,48	1,92	4,95
M-10	1,37	2,52	2,62	5,50	4,66	9,06	8,94	19,50	1,29	1,43	2,30	4,61	2,41	3,13	7,92
M-12	2,39	4,43	4,93	9,68	8,47	15,15	16,26	35,69	2,04	2,23	3,55	6,97	3,85	5,01	10,56
M-14	3,29	6,09	6,90	16,86	12,06	21,58	25,09	54,06	3,02	3,35	7,63	15,06	5,76	7,49	13,75
M-16	4,31	7,53	8,29	18,85	15,61	27,92	31,27	65,91	4,72	5,04	8,47	16,95	7,38	9,59	18,15
M-18	5,49	9,60	10,57	25,79	28,86	51,62	61,84	109,75	6,70	7,03	13,55	28,24	11,53	14,98	31,57
M-20	6,53	11,40	12,54	28,28	32,89	58,82	70,46	120,24	7,98	8,80	15,26	32,94	12,90	16,77	39,60
M-22	7,82	12,20	13,42	54,56	49,84		106,81	223,79	8,91	9,81	29,65	56,47	17,78	23,11	49,50
M-24	13,82	21,54	23,67	69,44	59,42		127,34	266,81	14,04	15,44	33,88	65,89	22,03	28,64	60,50
M-27	18,08	28,20	41,34	104,15					26,17	28,75	42,35	84,69			
M-30	22,91	35,74	52,38	128,94					44,71	48,89	59,30	122,35			
M-33	41,11		85,85	198,39					63,86	70,25					
M-36	50,29		114,00	270,00					92,57	111,74					
M-39	72,61		164,62	389,90					118,13	127,70					
M-42	99,92		226,51	536,49											
M-45	120,12		272,31	644,97											
M-48	160,52		363,92	861,89											
M-52	180,17		408,46	967,43											

ANILHAS DE VEDAÇÃO

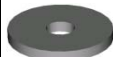

• EPDM • ZINCADAS • ALUMÍNIO • INOX-A2 • BORRACHA

ANILHAS VULCANIZADAS EPDM			ANILHAS CÔNCAVAS Ø 30 mm		ANILHAS CÔNCAVAS BORRACHA Ø 30mm		ANILHAS CÔNCAVAS Ø 19 mm	ANILHAS BORRACHA Ø 19 mm
								
DIÂMETRO	ZINCADO	INOX-A2	ZINCADO	INOX-A2	BORRACHA		ZINCADA	BORRACHA
14	1,84	5,05	3,20	15,40	3,20	1	3,20	3,20
16	2,07	5,90						
19	2,53	6,73						
25	4,37	12,63						

FREIOS DE SEGURANÇA EXTERIORES DIN 471



DIÂMETRO NOMINAL		PREÇO	DIÂMETRO NOMINAL		PREÇO	DIÂMETRO NOMINAL		PREÇO
4	5000	1,21	26	500	11,00	55	100	40,30
5	2500	1,21	27	500	11,00	56	100	47,80
6	2500	1,40	28	250	12,20	58	100	50,80
7	1500	1,80	29	250	12,90	60	100	44,70
8	4000	1,80	30	250	12,90	62	100	50,10
9	2000	2,10	32	250	17,50	65	75	62,70
10	1500	2,10	33	250	18,70	68	75	60,50
11	1500	2,40	34	250	18,70	70	75	55,80
12	1000	2,40	35	250	18,70	72	75	60,50
13	1000	3,10	36	100	22,50	75	75	60,50
14	1000	3,10	37	100	23,90	80	75	80,50
15	1000	3,60	38	100	23,90	82	75	86,60
16	1000	4,20	39	100	23,90	85	50	104,40
17	1000	4,50	40	100	24,40	90	50	116,30
18	1000	5,50	42	100	29,90	95	50	128,20
19	1000	6,20	44	100	32,80	100	50	143,20
20	1000	6,60	45	100	32,80	110	40	337,10
21	1000	7,60	46	100	35,80	120	40	353,40
22	500	7,90	47	100	35,80	130	40	363,80
23	500	8,90	48	100	35,80	140	40	313,70
24	500	8,90	50	100	35,80	150	40	449,20
25	500	9,60	52	100	38,90			

FREIOS DE SEGURANÇA INTERIORES DIN 472



DIÂMETRO NOMINAL		PREÇO	DIÂMETRO NOMINAL		PREÇO	DIÂMETRO NOMINAL		PREÇO
10	3000	2,10	30	170	11,70	60	100	35,80
11	2500	2,10	32	170	12,50	62	100	35,80
12	1000	2,10	33	170	14,40	65	75	50,10
13	2500	2,10	34	125	13,90	70	75	59,50
14	1000	2,40	35	125	14,00	72	75	57,80
15	2500	2,90	36	125	15,00	75	75	59,50
16	2000	3,30	37	125	16,60	80	75	62,70
17	2000	3,80	38	125	17,20	82	75	69,10
18	200	4,20	40	100	20,90	85	50	81,30
19	200	4,50	42	100	23,30	90	50	86,20
20	200	4,50	43	100	24,10	95	50	94,00
21	200	5,80	44	100	25,50	100	50	100,20
22	200	5,80	45	100	23,90	110	40	206,00
23	170	6,80	46	100	26,30	115	40	224,00
24	170	7,60	47	100	24,70	120	40	230,40
25	170	7,90	48	100	28,40	130	40	266,40
26	170	8,70	50	100	26,90	140	40	301,60
27	170	9,40	52	100	28,40	150	40	353,10
28	170	10,20	55	100	32,80			
29	170	11,00	58	100	38,90			

FREIOS "DE CAVALEIRO" BENSING DIN 6799



DIÂMETRO DA GOLA		PREÇO	DIÂMETRO DA GOLA		PREÇO	DIÂMETRO DA GOLA		PREÇO
1,5	10 000	0,77	6	2 500	1,70	15	500	16,10
1,9	10 000	0,66	7	2 500	2,20	19	250	22,20
2,3	5 000	0,80	8	2 000	3,10	24	200	32,56
3,2	5 000	0,80	9	1 000	4,20	30	100	104,06
4	2 500	1,00	10	1 000	5,40			
5	1 250	1,40	12	1 000	7,40			

**GOLPILHAS OU CHAVETAS
1/2 CANA "LEONE" - DIN 94
ZINCADAS - INOX A2**

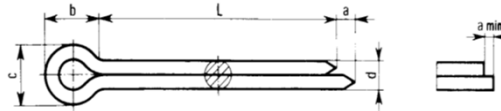

• FERRO ZINCADO

DIÂM. DO FURO	1	1,6	2	2,5	3,2	4	5	6,3	8	10	13	
d max (mm)	0,9	1,4	1,8	2,3	2,9	3,7	4,6	5,9	7,3	9,3	12,4	
COMPRIMENTO L (mm)	16	0,90	0,96	1,04	1,25							
	20	0,96	1,01	1,10	1,31	1,39						
	25	1,02	1,08	1,15	1,38	1,54	2,63					
	32	1,28	1,33	1,44	1,66	1,86	3,12	4,75				
	36		1,44	1,52	1,81	1,96	3,28	5,05	6,54			
	40		1,62	1,72	2,03	2,17	3,64	5,38	7,49			
	50				2,45	2,60	4,30	6,30	8,92	18,04		
	63					3,28	5,36	7,60	11,08	21,44	39,76	
	71						6,04	8,02	12,11	23,04	42,48	
	80							8,81	13,15	25,82	48,02	
	90							9,67	14,44	28,54	53,66	
	100							10,50	15,90	30,72	59,40	125,78
120									35,74	71,17	142,07	
140										83,36	155,98	

• INOX-A2

DIÂM. DO FURO	1	1,6	2	2,5	3,2	4	5	6,3	8	10	13	
d max (mm)	0,9	1,4	1,8	2,3	2,9	3,7	4,6	5,9	7,3	9,3	12,4	
COMPRIMENTO L (mm)	20	5,92	7,24	8,57	10,87	16,46						
	25	6,06	7,48	8,98	11,39	18,13	23,85					
	32	6,23	7,85	9,46	12,50	19,64	25,61	31,62				
	36		7,97	9,65	13,03	19,91	27,61	33,94	41,06			
	40		8,09	9,90	13,90	21,04	29,09	36,96	44,89			
	50					23,93	31,40	43,22	54,32	93,01		
	63					34,29	37,17	51,13	67,03	107,48		
	71						38,86	54,20	74,10	113,37		
	80								78,72	122,49		
	90									131,22		

GOLPILHAS BETA

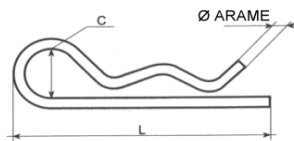

• AÇO ZINCADO

DIÂMETRO DO ARAME (mm)	2	2,5	3	3,5	4	4,5	5	6	7	8
C (mm)	11	16	22	22	21	23	24	25	26	26
L (mm)	47	64	68	74	86	90	97	108	123	140
PREÇO	6,85	8,30	11,84	14,11	18,60	24,82	35,65	58,06	96,89	126,19

**CHAVETAS DE ARGOLA
DIN 11023 - ZINCADAS**

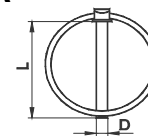

• ZINCADAS

MEDIDA	4,5	6	7	8	9	10	11
DxL	4,30 x 37	5,80 x 37	6,80 x 40	7,80 x 46	8,80 x 46	9,80 x 46	10,80 x 46
PREÇO	21,00	26,15	27,71	29,29	35,77	41,53	45,20

**CAVILHAS ELÁSTICAS
DIN 1481 - PRETO
- ISO 8752 -**



• PRETO

DIÂM. COMP: mm	1,5	2	2,5	3	4	5	6	8	10	12
5										
6		3,19	3,23	3,64	4,75	6,42				
8		3,26	3,42	3,77	4,89	6,57				
10		3,33	3,56	3,89	5,02	6,65	7,69	14,54		
12		3,39	3,62	4,02	5,16	6,80	7,99	14,70	37,46	
16		3,59	3,86	4,21	5,44	7,25	8,67	15,22	24,13	
18		3,59	4,05	4,34	5,51	7,47	9,34	15,98	25,75	
20		3,85	4,11	4,41	5,64	7,84	10,01	16,74	27,28	
22		3,98	4,17	4,53	5,79	8,29	10,68	16,74	28,99	
24		4,11	4,23	4,66	5,92	8,67	11,35	17,24	30,52	
26		4,24	4,29	4,79	6,13	9,11	11,95	21,25	32,14	
28		4,44	4,23	5,04	6,41	9,41	12,62	22,78	35,38	
30		4,63	4,79	5,23	6,68	9,86	14,16	24,31	38,54	
32			5,02	5,49	6,89	10,23	14,87	24,31	41,78	
36			5,10	5,87	7,92	10,98	16,21	27,70	46,10	
40			5,45	6,83	8,61	11,58	16,93	28,82	48,26	
45					10,00	11,95	20,39	30,34	48,26	
50					11,02	13,37	21,97	33,40	57,90	
60						16,06	26,80	40,97	69,15	
70						19,34	31,37	50,14	80,40	
80						26,67	37,61	62,22	96,52	
90							47,10	74,37	112,54	
100							62,83	86,52	128,66	

**CAVILHAS ELÁSTICAS
DIN 1481 - INOX-A2
- ISO 8752 -**



• INOX-A2

EMBALAGEM: sacos de 100 Unidades

DIÂM. COMP: mm	1,5	2	2,5	3	4	5	6	8	10	12
5										
6		1,47	1,70	2,06	2,55	3,72				
8		1,52	1,74	2,17	2,89	4,08				
10		1,60	1,81	1,95	2,99	4,44	6,66	7,16		
12		1,86	2,10	2,15	3,44	4,80	7,06	9,00	18,23	
16		2,01	2,15	2,49	3,91	5,13	7,30	12,67	21,38	
18		2,21	2,43	2,82	4,03	5,90	8,28	14,50	22,96	
20		2,41	2,49	2,83	4,33	6,09	8,93	16,34	24,13	
22		2,65	2,64	3,19	5,80	6,80	9,14	18,18	25,75	
24		2,80	2,78	3,42	5,98	7,50	10,56	20,01	27,67	
26		2,92	2,87	3,71	6,08	7,71	11,99	21,85	28,60	
28		2,98	2,98	3,91	6,82	9,28	12,41	22,66	29,74	
30		3,05	3,18	3,80	6,89	9,33	13,12	23,47	32,63	
32			3,93	4,91	7,43	10,30	14,80	24,02	33,40	
36			4,43	5,13	8,14	11,20	16,75	25,12	34,93	
40			6,09	6,76	8,91	12,31	17,32	28,90	40,19	
50					10,61	15,68	21,65	35,62	49,54	
60						18,82	25,98	43,15	83,34	
70						24,39	31,98	53,92	100,13	
80						28,20	46,60	64,84	122,40	
90							66,86	75,65	159,55	
100							83,36	86,54	196,70	

REBITES DIN 7337



• ALUMÍNIO • COBRE • AÇO • AÇO INOX-A2 • LACADO

PRETO

BRANCO

VERDE

RAL 6005

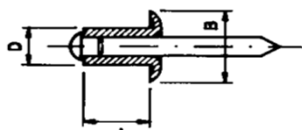

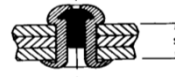
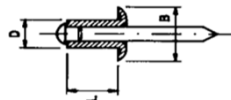

TAMANHO		CARACTERÍSTICAS DIMENSIONAIS (mm)			MATERIAL				
DIÂMETRO	COMPRIMENTO O L	D	B	S	LACADO	AÇO	COBRE	INOX-A2	ALUMÍNIO
2,4	6	2,4	5	2,0-4,0					0,79
	8	2,4	5	4,0-6,0					0,81
	9	2,4	5	6,0-7,0					0,92
	12	2,4	5	8,0-10,0					1,46
3	6	3,2	6,5	1,0-3,5		1,22		2,57	0,67
	7	3,2	6,5	3,5-4,5			6,35		0,68
	8	3,2	6,5	4,5-5,5	1,30	1,25		2,68	0,69
	9	3,2	6,5	5,5-6,5			6,79		0,71
	10	3,2	6,5	6,5-7,0	1,37	1,42		2,94	0,73
	12	3,2	6,5	7,0-9,0	1,47	1,53	7,94	3,07	0,77
	14	3,2	6,5	9,0-11,0				3,91	0,89
	16	3,2	6,5	11,0-13,0				4,25	0,97
	18	3,2	6,5	13,0-15,0					1,21
20	3,2	6,5	15,0-17,0					1,31	
4	6	3,9	8,1	1,5-3,0		1,54	8,28	3,42	0,86
	7	3,9	8,1	3,0-4,0			8,77	3,53	0,88
	8	3,9	8,1	4,0-5,0	1,50	1,60		3,58	0,90
	9	3,9	8,1	5,0-6,0			9,96		
	10	3,9	8,1	6,0-7,0	1,67	1,67		3,83	0,99
	11	3,9	8,1	5,5-7,0			11,06		
	12	3,9	8,1	7,0-8,5	1,77	1,80	11,54	4,10	1,04
	14	3,9	8,1	9,0-11,0	1,94			4,73	1,14
	16	3,9	8,1	8,5-11,5	2,10	2,02	13,49	5,03	1,22
	18	3,9	8,1	10,0-14,0					1,31
	20	3,9	8,1	12,5-16,5		2,48	15,05	6,39	1,41
	30	3,9	8,1	21-26					2,90
5	8	4,8	9,5	1,5-3,0	2,48	2,10	15,54	5,45	1,31
	10	4,8	9,5	4,0-6,0	2,68	2,21	15,71	5,83	1,40
	12	4,8	9,5	6,0-8,0	2,89	2,39	16,04	6,27	1,49
	14	4,8	9,5	8,0-10,0	3,19			6,60	1,64
	16	4,8	9,5	10,0-13,0	3,37	2,64	18,08	7,18	1,71
	18	4,8	9,5	12,0-15,0		2,98		7,50	1,83
	20	4,8	9,5	12,0-15,0	4,01	3,26		8,14	2,05
	25	4,8	9,5	16,0-19,0		4,07		9,39	2,34
	27	4,8	9,5	18,0-21,0					3,03
	30	4,8	9,5	21,0-25,2		4,19			3,22
	35	4,8	9,5	25,0-30,0					6,55
6	12	5,9	12	4,5-7,0					4,59
	16	5,9	12	6,5-10,0					5,12
	20	5,9	12	11,0-14,0					6,20
	25	5,9	12	16,5-21,0					6,53
	30	5,9	12	20,5-25,0					7,75

REBITES DE ABA LARGA





• ALUMÍNIO

DIÂMETRO mm	COMPRIM. mm	D mm	S mm	ABA (B) mm				PREÇO
5	8	4,80	2,5-4,0	14	2800 N	2050 N	500	4,56
	10		4,5-6,0				500	2,78
	12		6,0-8,0				500	2,98
	14		8,0-10,0				250	3,24
	16		10,0-13,0				250	3,34
	18		12,0-15,0				250	3,39
	19		12,0-16,0				250	3,59
	21		14,0-16,0				250	3,73
	25		16,0-19,0				250	4,38
	27		18,0-21,0				250	5,69
	30		20,0-26,0				250	5,91
	35		25,0-28,0				250	11,50
	40		27,0-32,0				250	12,63

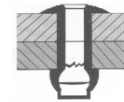
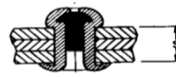
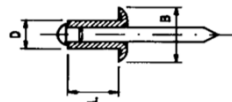
REBITES ESTANQUES





• ALUMÍNIO

DIÂMETRO mm	COMPRIM. mm	D mm	S mm	ABA (B) mm				PREÇO
4	10	4,00	2,3-4,2	7,8	2480 N	1700 N	1000	3,46
	13		4,8-7,2				1000	3,74
5	10	4,80	1,1-3,7	9,4	4150 N	2640 N	1000	4,18
	12		5,3-6,7				500	4,39
	16		8,8-9,7				500	4,75
	18		9,8-12,2				500	5,04
	20		11-14,2				500	5,40

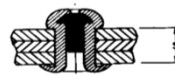
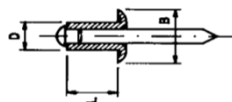
REBITES FLOR



• ALUMÍNIO

DIÂMETRO mm	COMPRIM. mm	D mm	S mm	ABA (B) mm				PREÇO
4	12	4,00	2,5-6,0	7,8	2050 N	1300 N	1000	2,25
	16		5,5-10,0				1000	2,66
	20		9,5-14,0				1000	2,95
5	10	4,80	4,5-6,0	9,4	2800 N	2050 N	1000	3,10
	12		6,0-8,0				1000	3,24
	14		8,0-10,0				1000	3,31
	16		10,0-13,0				1000	3,38
	20		14,0-16,0				500	4,18
	25		16,0-19,0				500	4,68
	30		20,0-26,0				500	5,54
	35		25,0-28,0				500	6,41

PORCAS DE REBITAR ESTRIADAS



• AÇO ZINCADO

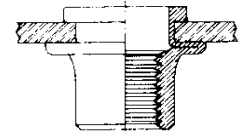
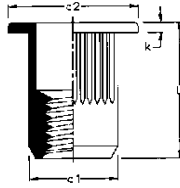

MEDIDA	Ø FURO	ESPESSURA A FIXAR	d1 mm	d2 mm	k mm	INOX A2			ZINCADO		
						L [mm]		PREÇO	L [mm]		PREÇO
M-4	6,0	0,5 - 3,5	5,9	9,0	1,0	10,0	1000	20,00	11,6	1500	2,66
M-5	7,0	0,5 - 3,5	6,9	10,0	1,0	12,0	1000	24,00	13,0	1000	2,98
M-6	9,0	1,0 - 4,0	8,9	12,0	1,5	14,5	500	38,00	16,0	500	3,74
M-8	11,0	1,0 - 4,0	10,9	15,0	1,5	16,0	200	52,00	18,0	350	5,29
M-10	13,0	1,0 - 5,0	12,9	19,0	1,7	21,0	100	110,00	21,0	180	8,44

PORCAS DE REBITAR - ESTRIADAS CABEÇA REDUZIDA



• AÇO ZINCADO

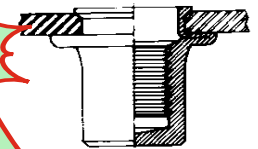
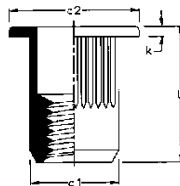

MEDIDA	Ø FURO	ESPESSURA A FIXAR	C1 mm	C2 mm	k mm	INOX A2			ZINCADO		
						L [mm]		PREÇO	L [mm]		PREÇO
M-4	6,0	0,5 - 3,5	5,9	7,0	0,6	11,0	1000	18,00	10,0	1500	2,66
M-5	7,0	0,5 - 3,5	6,9	8,0	0,6	12,0	1000	22,00	12,0	1000	2,98
M-6	9,0	1,0 - 4,0	8,9	10,0	0,6	14,5	500	34,00	15,0	500	3,74
M-8	11,0	1,0 - 4,0	10,9	12,0	0,6	16,0	200	46,00	16,0	350	5,29
M-10	13,0	1,0 - 5,0	12,9	16,0	0,6	17,7	100	105,00	20,0	180	8,44

PORCAS DE REBITAR - ESTRIADAS CABEÇA DE EMBEBER



• AÇO ZINCADO

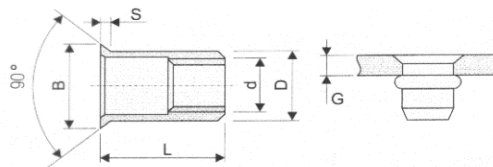

MEDIDA	Ø FURO -0,0 +0,1	ESPESSURA A FIXAR	D [mm] +0,0 -0,1	B mm	S mm	L mm		PREÇO
M-4	6,4	0,5 - 2,5	6,3	7,1	0,5	11,6	1500	2,66
M-5	7,2	0,5 - 3,0	7,1	8,1	0,6	13,0	1000	2,98
M-6	9,6	0,7 - 3,5	9,5	10,5	0,6	16,0	500	3,74
M-8	10,6	1,0 - 3,5	10,5	11,5	0,6	18,5	350	5,29
M-10	12,8	1,0 - 4,0	12,7	13,9	0,6	22,0	180	8,44

ALICATE DE REBITAR HR-702 E HR-705



- Aço estampado - HR-702
- Liga de Alumínio - HR-705

HR-702	CARACTERÍSTICAS	PREÇO / Un.
	<ul style="list-style-type: none"> • Aço estampado - 1 mordente; • Capacidade Alumínio - até Ø 4,8 mm Outros - até Ø4 mm • Peso - 0,530 Kg • Comprimento - 255 mm 	9,00
HR-705	CARACTERÍSTICAS	PREÇO / Un.
	<ul style="list-style-type: none"> • Liga de Alumínio - 2 mordentes; • Capacidade - até Ø 4,8 mm • Peso - 0,530 Kg • Comprimento - 255 mm 	14,00

ALICATES DE REBITAR DE LAGARTAS HR-710

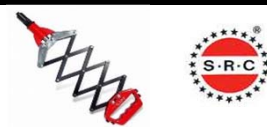

- De lagartas HR-710 - Para uso industrial

HR-710	CARACTERÍSTICAS	PREÇO / Un.
	<ul style="list-style-type: none"> • Aço cromado tratado termicamente - 3 mordentes; • Sistema de alavancas em treliça para reduzir a fadiga do operador; • Design estreito para aplicações de difícil acesso; • Capacidade - até Ø 6,4 mm • Acessórios - pontas de 3,2 - 4,0 - 4,8 - 6,0 e 6,4 mm (chave incluída); • Peso - 1,960 Kg • Comprimento - 300-810 mm 	46,00

ALICATES DE REBITAR DE BRAÇOS HR-730



- De braços HR-730 - Para uso industrial

HR-730	CARACTERÍSTICAS	PREÇO / Un.
	<ul style="list-style-type: none"> • Sistema de 3 mordentes; • Sistema de alavancas para reduzir o esforço físico do operador; • Design das pegas para maior conforto, segurança e usabilidade; • Capacidade - até Ø 6,4 mm • Acessórios - pontas de 3,2 - 4,0 - 4,8 - 6,0 e 6,4 mm (chave incluída); • Peso - 1,845 Kg • Comprimento - 540 mm 	51,00

ALICATE PARA PORCAS DE REBITAR



- HN - 02 - Ferramenta manual profissional com kit de acessórios para porcas de rebitar

HN - 02	CARACTERÍSTICAS	PREÇO / Un.
	<ul style="list-style-type: none"> • Ferramenta manual profissional; • Medidas: M4, M5, M6, M8 e M10; • Acessórios: cinco pontas (M4, M5, M6, M8 e M10); • Peso: 1.64 kg. 	<p>190,00</p>

PISTOLAS PNEUMÁTICAS PARA PORCAS DE REBITAR SN-6 E SN-10



- Ferramentas pneumáticas profissionais com kit de acessórios para porcas de rebitar

SN-6	CARACTERÍSTICAS	PREÇO / Un.
	<ul style="list-style-type: none"> • Ferramenta pneumática leve e de grande capacidade; • Enrosca e desenrosca a porca automaticamente accionando um botão; • Medidas: M4 a M6 - Alumínio, aço, aço INOX; • Tamanho (LxWxH): 320x80x190 mm; • Pressão do ar: 85 a 95 psi; • Peso: 1,85 kg. 	<p>1500,00</p>
SN-10	CARACTERÍSTICAS	PREÇO / Un.
	<ul style="list-style-type: none"> • Ferramenta pneumática leve e de grande capacidade; • Enrosca e desenrosca a porca automaticamente; • Medidas: M5 a M12 - Alumínio, aço, aço INOX; • Tamanho (LxWxH): 320x150x280 mm; • Pressão do ar: 85 a 95 psi; • Peso: 2,45 kg. 	<p>1 700,00</p>



PISTOLAS DE REBITAR PNEUMÁTICAS









SRC - 55P	CARACTERÍSTICAS	PREÇO / Un
	<ul style="list-style-type: none"> • Design leve para reduzir a fadiga do operador; • Elevada velocidade de aplicação; • Aperto mais longo - pode aplicar rebites com corpo longo de uma só vez; • Capacidade de rebiteagem - de 3,2 a 4,8 mm (1/8" a 3/16") para todos os materiais; • Ruído minimizado; • Peças maquinadas e vedantes de qualidade para prolongar a vida da pistola; • Construção ergonômica permite uma colocação rápida; • Fluxo de ar ajustável por vacuo para reduzir o consumo de ar; • Peso: 1,2 kg; • Aperto - 18 mm. 	<p>240,00</p>
SRC - 56P	CARACTERÍSTICAS	PREÇO / Un
	<ul style="list-style-type: none"> • Design leve para reduzir a fadiga do operador; • Elevada velocidade de aplicação; • Aperto mais longo - pode aplicar rebites com corpo longo de uma só vez; • Capacidade de rebiteagem - de 4,0 a 6,4 mm (5/32" a 1/4") para todos os materiais; • Ruído minimizado; • Peças maquinadas e vedantes de qualidade para prolongar a vida da pistola; • Construção ergonômica permite uma colocação rápida; • Fluxo de ar ajustável por vacuo para reduzir o consumo de ar; • Peso: 1,5 kg; • Aperto - 20 mm. 	<p>260,00</p>

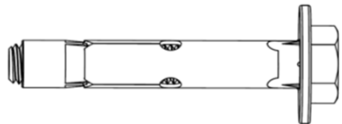



PISTOLAS DE REBITAR PNEUMÁTICAS SISTEMA DE VÁCUO

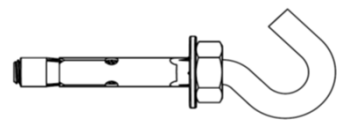
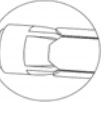

SRC - A5	CARACTERÍSTICAS	PREÇO / Un
	<p><i>Sistema de vácuo</i></p> <ul style="list-style-type: none"> • Design leve para reduzir a fadiga do operador; • Elevada velocidade de aplicação; • Aperto mais longo - pode aplicar rebites com corpo longo de uma só vez; • Capacidade de rebiteagem - de 3,2 a 4,8 mm (1/8" a 3/16") para todos os materiais; • Ruído minimizado; • Peças maquinadas e vedantes de qualidade para prolongar a vida da pistola; • Construção ergonômica permite uma colocação rápida; • Fluxo de ar ajustável por vacuo para reduzir o consumo de ar; • Peso: 1,2 kg; • Aperto - 18 mm. 	<p>380,00</p>
SRC - A6	CARACTERÍSTICAS	PREÇO / Un
	<p><i>Sistema de vácuo</i></p> <ul style="list-style-type: none"> • Design leve para reduzir a fadiga do operador; • Elevada velocidade de aplicação; • Aperto mais longo - pode aplicar rebites com corpo longo de uma só vez; • Capacidade de rebiteagem - de 4,0 a 6,4 mm (5/32" a 1/4") para todos os materiais; • Ruído minimizado; • Peças maquinadas e vedantes de qualidade para prolongar a vida da pistola; • Construção ergonômica permite uma colocação rápida; • Fluxo de ar ajustável por vacuo para reduzir o consumo de ar; • Peso: 1,5 kg; • Aperto - 20 mm. 	<p>420,00</p>

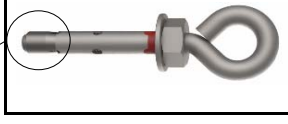
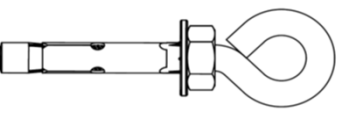
		BUCHAS CH BUCHAS EXPANSIVAS DE 3 ELEMENTOS COM PARAFUSO				   ANTIGIRO			 	
ROSCA	REFERÊNCIA	PARAFUSO	BROCA	PROFUND. DO FURO	ESPESS. MÁX. MATERIAL A FIXAR	ÃO INOX-A4 AISI 316	ÃO INOX-A2 AISI 304	ÃO ZINCADO		
M-6	M-6 Ø8x45	M-6x45	8 mm	50 mm	6 mm	115,34	62,42	15,86		
	M-6 Ø8x60	M-6x60	8 mm	65 mm	10 mm	127,01	69,77	18,14		
M-8	M-8 Ø10x60	M-8x60	10 mm	65 mm	6 mm	199,58	108,94	27,33		
	M-8 Ø10x80	M-8x80	10 mm	85 mm	12 mm	233,28	127,30	33,88		
M-10	M-10 Ø12x70	M-10x70	12 mm	75 mm	10 mm	451,01	248,47	48,09		
	M-10 Ø12x100	M-10x100	12 mm	105 mm	20 mm	541,73	294,98	61,21		
M-12	M-12 Ø16x80	M-12x80	16 mm	85 mm	12 mm	869,62	481,03	95,09		
	M-12 Ø16x100	M-12x100	16 mm	105 mm	30 mm	1 049,76	588,74	112,58		
M-16	M-16 Ø20x110	M-16x110	20 mm	115 mm	30 mm	2 082,67	1 161,58	229,52		
M-20	M-20 Ø25x130	M-20x130	25 mm	135 mm	30 mm			491,83		

		BUCHAS CH BUCHAS EXPANSIVAS DE 3 ELEMENTOS COM GANCHO				   ANTIGIRO		 	
ROSCA	REFERÊNCIA	BROCA	PROFUNDIDADE DO FURO	ESPESSURA MÁX. MATERIAL A FIXAR	ÃO INOX-A2 AISI 304	ÃO ZINCADO			
M-6	M-6 Ø8x45 GA	8 mm	60 mm	6 mm	164,16	37,06			
M-8	M-8 Ø10x60 GA	10 mm	70 mm	6 mm	273,60	64,15			
M-10	M-10 Ø12x70 GA	12 mm	80 mm	10 mm	764,64	135,43			
M-12	M-12 Ø16x80 GA	16 mm	90 mm	12 mm	1 264,32	228,10			

		BUCHAS CH BUCHAS EXPANSIVAS DE 3 ELEMENTOS COM OLHAL				   ANTIGIRO		 	
ROSCA	REFERÊNCIA	BROCA	PROFUNDIDADE DO FURO	ESPESSURA MÁX. MATERIAL A FIXAR	ÃO INOX-A2 AISI 304	ÃO ZINCADO			
M-6	M-6 Ø8x45 OL	8 mm	60 mm	6 mm	164,16	37,06			
M-8	M-8 Ø10x60 OL	10 mm	70 mm	6 mm	273,60	64,15			
M-10	M-10 Ø12x70 OL	12 mm	80 mm	10 mm	764,64	135,43			
M-12	M-12 Ø16x80 OL	16 mm	90 mm	12 mm	1 264,32	228,10			

BUCHAS CH - PARAFUSO DE EMBEBER
BUCHAS EXPANSIVAS DE 3 ELEMENTOS
COM PARAFUSO DIN 7991 INOX A2



• **AÇO ZINCADO - PARAFUSO AÇO INOX-A2 (AISI 304)**



PORCA ANTIGIRO EM AÇO ZINCADO

MANGA EM AÇO ZINCADO

PARAFUSO DIN 7991 EM AÇO INOX A2

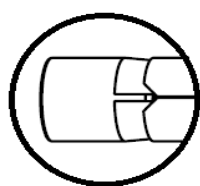
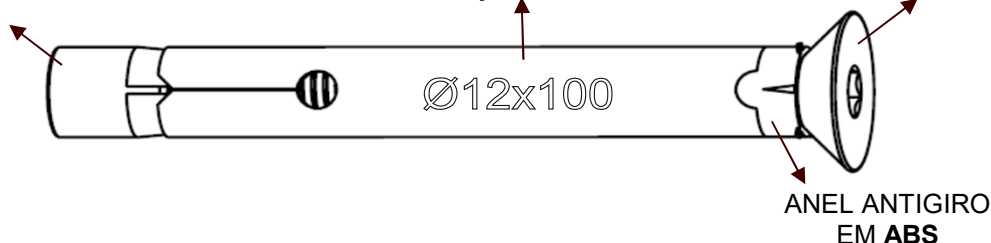

**CAMISA,
 CONE E GOLA
 ANTIGIRO**

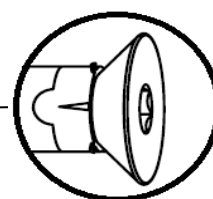

CARACTERÍSTICAS

- Fixação metálica com princípio de funcionamento por expansão e binário de instalação controlado;
- Para cargas elevadas;
- Para usos estruturais em betão não fissurado;
- Fácil instalação;
- Antigiros incorporados na camisa, cone e gola;
- Adequado para cargas estáticas e quase-estáticas;
- Instalação através dos furos das placas de fixação;
- Camisa e cone em aço zincado e parafuso em aço INOX A2;
- Variedade de medidas, flexibilidade na montagem.

APLICAÇÕES

- Fixações estruturais em betão não fissurado;
- Fixação de sinais, estantes, painéis, pórticos, guarda-corpos, toldos...;
- Mobiliário urbano, assentos de cinemas, teatros e estádios.

MATERIAL BASE

- Betão não-fissurado.

CONDIÇÕES DOS FUROS

- Secos, húmidos ou inundados.

ROSCA	MEDIDAS	PARAFUSO	BROCA	PROFUND. DO FURO	ESPESSURA MÁXIMA MATERIAL A FIXAR		AÇO ZINCADO
							PARAFUSO AÇO INOX-A2
M-6	M-6 Ø8x45	M-6x45	8 mm	45 mm	5 mm	100	26,00
	M-6 Ø8x60	M-6x60			20 mm	100	31,00
M-8	M-8 Ø10x60	M-8x60	10 mm	60 mm	5 mm	50	48,00
	M-8 Ø10x80	M-8x80			27 mm	50	63,00
M-10	M-10 Ø12x70	M-10x70	12 mm	75 mm	5 mm	50	84,00
	M-10 Ø12x100	M-10x100			32 mm	25	124,00

BUCHAS DE CUNHA "MTA"



- AÇO ZINCADO
- AÇO INOX-A2 (AISI 304)
- AÇO INOX-A4 (AISI 316)



DESIGNAÇÃO	CARACTERÍSTICAS DIMENSIONAIS (mm)						MATERIAL		
	COMPRIMENTO TOTAL	DIÂMETRO DO FURO	PROFUNDIDADE DO FURO	ESPESSURA DO MATERIAL A FIXAR	AÇO INOX AISI 316 - A4		AÇO INOX AISI 304 - A2	AÇO ZINCADO	
M-6	M-6x45	45	6	40	2	100		46,44	13,84
	M-6x60	60	6	55	2	100	97,75	51,32	15,52
	M-6x70	70	6	55	12	100	107,81	57,43	16,26
	M-6x80	80	6	55	22	100	119,31	62,31	16,98
	M-6x130	130	6	55	72	50		97,75	23,78
	M-6x140	140	6	55	82	50		103,86	25,61
	M-6x150	150	6	55	92	50		120,96	27,44
	M-6x160	160	6	55	102	50		145,40	29,27
M-8	M-8x50	50	8	40	5	50		77,42	13,84
	M-8x60	60	8	50	5	50	147,66	78,59	15,52
	M-8x75	75	8	65	5	50	157,32	80,94	16,26
	M-8x80	80	8	65	20	50	164,22	85,63	16,98
	M-8x90	90	8	65	20	50	178,02	92,67	17,42
	M-8x100	100	8	65	30	50	193,20	99,71	20,24
	M-8x115	115	8	65	45	50	213,90	119,65	22,55
	M-8x120	120	8	65	50	50	220,80	130,20	23,29
	M-8x150	150	8	65	80	50		167,74	29,27
M-10	M-10x60	60	10	55	5	50		130,20	23,07
	M-10x70	70	10	55	5	50	237,36	143,11	23,92
	M-10x90	90	10	70	10	25	280,14	150,14	26,53
	M-10x100	100	10	70	20	25	302,22	161,87	28,64
	M-10x120	120	10	70	40	25	345,00	184,16	32,62
	M-10x150	150	10	70	70	25	445,74	219,35	39,12
	M-10x170	170	10	70	90	25	492,66	261,58	51,38
M-12	M-12x75	70	12	60	5	25	367,08	206,45	34,35
	M-12x90	90	12	75	5	25	414,00	213,49	38,70
	M-12x100	100	12	85	15	25	445,74	228,74	40,84
	M-12x110	110	12	85	18	25	477,48	238,12	42,01
	M-12x120	120	12	85	28	25	509,22	261,58	47,55
	M-12x140	140	12	85	48	25	571,32	294,42	53,48
	M-12x160	160	12	85	68	20	692,76	353,07	67,12
	M-12x180	180	12	85	88	20	761,76	388,26	77,30
M-16	M-16x90	90	16	75	5	20	875,44	413,00	69,58
	M-16x100	100	16	85	5	20	943,00	443,54	73,38
	M-16x110	110	16	95	5	25	1 009,13	461,87	78,53
	M-16x125	125	16	110	10	25	1 016,31	471,65	84,71
	M-16x145	145	16	110	23	25	1 137,06	527,85	94,25
	M-16x170	170	16	110	48	20	1 805,21	643,93	119,37
	M-16x180	180	16	110	58	20	2 062,81	834,54	135,47
	M-16x220	220	16	110	98	20	2 435,13	986,05	147,54
M-20	M-20x120	120	20	120	2	10		1 066,70	152,70
	M-20x140	140	20	130	10	10		1 191,33	168,94
	M-20x150	150	20	130	15	10	2 272,69	1 254,86	170,99
	M-20x160	160	20	135	15	10	2 384,81	1 317,19	174,17
	M-20x170	170	20	135	23	10	2 498,38	1 336,74	179,85
	M-20x220	220	20	135	73	15	3 064,75	1 717,96	224,74
	M-20x270	270	20	135	123	10		2 204,26	320,26

BUCHAS DE CUNHA "MTA" CERTIFICADAS CERTIFICAÇÃO ETA - OPÇÃO 1



- S-KA - AÇO ZINCADO
- S-KAH - AÇO INOX-A4 (AISI 316)



Ø BUCHA	BINÁRIO DE APERTO [N•m]	CARGAS ADMISSÍVEIS BETÃO NÃO FISSURADO [kN]	
		EXTRACÇÃO	CORTE
M-8	20	3,6	4,8
M-10	35	6,3	8,7
M-12	50	7,9	11,0
M-16	120	16,7	21,0
M-20	240	13,9	13,9

DESIGNAÇÃO			CARACTERÍSTICAS DIMENSIONAIS [mm]						MATERIAL	
			COMPRIMENTO TOTAL	Ø FURO	PROFUNDIDADE DO FURO	ESPESSURA DO MATERIAL A FIXAR	AÇO INOX AISI 316 - A4		AÇO ZINCADO	
MEDIDA	REFERÊNCIA									
M-8	M-8x75	S-KA(H) 8/10	72	8	60	10	50	147,00	40,00	
	M-8x90	S-KA(H) 8/30	92	8	60	30	50	173,00	46,00	
	M-8x115	S-KA(H) 8/50	112	8	60	50	40	205,00	54,00	
	M-8x150	S-KA 8/85	147	8	60	85	40		71,00	
M-10	M-10x90	S-KA(H) 10/10	92	10	75	10	40	259,00	60,00	
	M-10x100	S-KA(H) 10/20	102	10	75	20	25	278,00	67,00	
	M-10x110	S-KA(H) 10/30	112	10	75	30	25	302,00	67,00	
	M-10x130	S-KA(H) 10/50	132	10	75	50	25	354,00	78,00	
	M-10x160	S-KA 10/80	162	10	75	80	25		89,00	
M-12	M-12x100	S-KA(H) 12/5	103	12	90	5	20	410,00	86,00	
	M-12x120	S-KA(H) 12/20	118	12	90	20	20	452,00	88,00	
	M-12x130	S-KA(H) 12/30	128	12	90	30	20	494,00	101,00	
	M-12x150	S-KA(H) 12/50	148	12	90	50	20	494,00	112,00	
	M-12x165	S-KA(H) 12/65	163	12	90	65	20	581,00	121,00	
	M-12x180	S-KA 12/80	178	12	90	80	20		142,00	
M-16	M-16x125	S-KA(H) 16/5	123	16	110	5	10	899,00	198,00	
	M-16x140	S-KA(H) 16/20	138	16	110	20	10	983,00	217,00	
	M-16x170	S-KA(H) 16/50	168	16	110	50	10	1104,00	236,00	
	M-16x180	S-KA 16/60	178	16	110	60	10		256,00	
	M-16x215	S-KA 16/95*	213	16	110	95	10		530,00	
M-20	M-20x170	S-KA(H) 20/20*	170	20	130	20	5	3098,00	578,00	
	M-20x220	S-KA(H) 20/70*	220	20	130	70	5	3762,00	684,00	
	M-20x280	S-KA 20/130*	280	20	130	130	5		717,00	

Edição: 1/2006
Data: Setembro 2006

Revisão: 1
Data: Agosto 2010

Preço: €100

TABELA 7.2 A

BUCHAS EM AÇO "FB"



• ZINCADO • AÇO INOX-A2



DESIGNAÇÃO	ROSCA	COMPRIMENTO DA BUCHA	BROCA		AÇO INOX-A4	AÇO INOX-A2	ZINCADA
FB M-6	M-6	40 mm	10 mm	50	90,00	74,10	8,28
FB M-8	M-8	50 mm	13 mm	50	132,00	102,60	13,12
FB M-10	M-10	60 mm	16 mm	25	216,00	159,60	19,85
FB M-12	M-12	80 mm	19 mm	25	550,00	285,00	36,25
FB M-16	M-16	100 mm	25 mm	10	1080,00	798,00	103,58

BUCHAS EM AÇO "FB" - COM PARAFUSO COM ANILHA ABA LARGA - DIN 9021



• ZINCADO • AÇO INOX-A2



DESIGNAÇÃO	PARAFUSO	COMPRIMENTO DA BUCHA	BROCA		AÇO INOX-A4	AÇO INOX-A2	ZINCADA
FB M-6 P	M-6 x 50	40 mm	10 mm	50	192,00	148,20	15,54
FB M-8 P	M-8 x 60	50 mm	13 mm	50	264,00	205,20	27,62
FB M-10 P	M-10 x 70	60 mm	16 mm	25	456,00	307,80	43,16
FB M-12 P	M-12 x 90	80 mm	19 mm	25	1320,00	969,00	82,00

BUCHAS EM AÇO "FB" COM GANCHO



• ZINCADO • AÇO INOX-A2



DESIGNAÇÃO	GANCHO	COMPRIMENTO DA BUCHA	BROCA		AÇO INOX-A2	ZINCADA
FB M-6 GA	M-6	40 mm	10 mm	50	180,00	35,10
FB M-8 GA	M-8	50 mm	13 mm	50	264,00	52,00
FB M-10 GA	M-10	60 mm	16 mm	25	450,00	91,00
FB M-12 GA	M-12	80 mm	19 mm	25	1 100,00	169,00

BUCHAS EM AÇO "FB" COM OLHAL

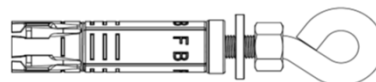

• ZINCADO • AÇO INOX-A2



DESIGNAÇÃO	OLHAL	COMPRIMENTO DA BUCHA	BROCA		AÇO INOX-A2	ZINCADA
FB M-6 OL	M-6	40 mm	10 mm	50	180,00	35,10
FB M-8 OL	M-8	50 mm	13 mm	50	264,00	52,00
FB M-10 OL	M-10	60 mm	16 mm	25	450,00	91,00
FB M-12 OL	M-12	80 mm	19 mm	25	1 100,00	169,00

BUCHAS EM AÇO "FB" COM ESCÁPULA



• ZINCADO • AÇO INOX-A2



DESIGNAÇÃO	ESCÁPULA	COMPRIMENTO DA BUCHA	BROCA		AÇO INOX-A2	ZINCADA
FB M-6 ES	M-6	40 mm	10 mm	50	180,00	35,10
FB M-8 ES	M-8	50 mm	13 mm	50	264,00	52,00

BUCHAS ZAMAK HPM



HPM

• ZINCADO

DESIGNAÇÃO	ROSCA	COMPRIMENTO DA BUCHA	PROFUNDIDADE DO FURO	BROCA		PREÇO
HPM - 6	M-6	40 mm	50 mm	12 mm	100	57,50
HPM - 8	M-8	50 mm	55 mm	14 mm	50	83,95
HPM - 10	M-10	58 mm	64 mm	16 mm	50	109,25
HPM - 12	M-12	71 mm	80 mm	20 mm	25	287,50
HPM - 16	M-16	115 mm	125 mm	25 mm	20	575,00
HPM - 20	M-20	130 mm	140 mm	32 mm	8	1 150,00
HPM - 24	M-24	145 mm	155 mm	38 mm	5	1 725,00

BUCHAS ZAMAK HPM COM PARAFUSO



HPM

• ZINCADO

DESIGNAÇÃO	PARAFUSO	COMPRIMENTO DA BUCHA	PROFUNDIDADE DO FURO	BROCA		PREÇO
TPM 6-10 L	M-6 x 50	45 mm	50 mm	12 mm	100	80,50
TPM 8-10 L	M-8 x 60	50 mm	55 mm	14 mm	50	138,00
TPM 10-10 L	M-10 x 65	58 mm	64 mm	16 mm	25	207,00
TPM 12-10 L	M-12 x 80	71 mm	80 mm	20 mm	20	345,00

BUCHAS ZAMAK HPM COM GANCHO ESTAMPADO



HPM

• ZINCADO

DESIGNAÇÃO	GANCHO	COMPRIMENTO DA BUCHA	PROFUNDIDADE DO FURO	BROCA		PREÇO
H.A. - 6	M-6	45 mm	50 mm	12 mm	50	115,00
H.A. - 8	M-8	50 mm	55 mm	14 mm	25	184,00
H.A. - 10	M-10	58 mm	64 mm	16 mm	20	276,00
H.A. - 12	M-12	71 mm	80 mm	20 mm	10	460,00

BUCHAS ZAMAK HPM COM OLHAL ESTAMPADO



HPM

• ZINCADO

DESIGNAÇÃO	OLHAL	COMPRIMENTO DA BUCHA	PROFUNDIDADE DO FURO	BROCA		PREÇO
H. C. - 6	M-6	45 mm	50 mm	12 mm	50	115,00
H. C. - 8	M-8	50 mm	55 mm	14 mm	25	184,00
H. C. - 10	M-10	58 mm	64 mm	16 mm	20	276,00
H. C. - 12	M-12	71 mm	80 mm	20 mm	10	460,00

**BUCHA "JUNIOR"
(COM TACO INTERIOR)**



- AÇO ZINCADO
- AÇO INOX A-2 (AISI 304)
- AÇO INOX A-4 (AISI 316)



DESIGNAÇÃO	ROSCA	COMPRIMENTO	BROCA	INOX-A4		INOX-A2		ZINCADO	
JUNIOR M-6	M-6	25 mm	8 mm	100	103,20	100	75,60	100	8,51
JUNIOR M-8	M-8	30 mm	10 mm	100	154,80	100	106,80	100	12,53
JUNIOR M-10	M-10	40 mm	12 mm	50	309,60	50	189,60	50	20,29
JUNIOR M-12	M-12	50 mm	15 mm	50	514,80	50	326,40	50	37,96
JUNIOR M-16	M-16	60 mm	20 mm	25	1 201,20	25	772,80	25	101,73
JUNIOR M-20	M-20	80 mm	25 mm	25	2 059,20	25	1 544,40	25	308,55

BUCHAS DE LATÃO



- LATÃO



DESIGNAÇÃO	ROSCA	PROFUNDIDADE DO FURO	BROCA		PREÇO
LATÃO M-4	M-4	16 mm	5,0 mm	500	6,00
LATÃO M-5	M-5	18 mm	6,5 mm	300	7,00
LATÃO M-6	M-6	23 mm	8,0 mm	200	8,80
LATÃO M-8	M-8	28 mm	10 mm	100	20,00
LATÃO M-10	M-10	34 mm	12 mm	130	40,00
LATÃO M-12	M-12	38 mm	14 mm	70	80,00

**BUCHAS "PFG"
ANTI-CORROSIVA
(GALVANIZADA POR DIFUSÃO)**



• **ANTI-CORROSIVA (GALVANIZADA POR DIFUSÃO)**



APLICAÇÕES:

A bucha **PFG** destina-se a fixações médias/pesadas em materias sólidos duros como betão, tijolo (máx. M8) e pedra natural. Devido à sua grande capacidade de expansão é também adequada para o uso em materiais de qualidade e porosidade ligeiramente inferior, como os que que se encontram em muitas construções antigas.



**NOVAS BUCHAS PFG - ANTI-CORROSIVAS
- GALVANIZADAS POR DIFUSÃO -**

BUCHAS METÁLICAS COM REVESTIMENTO MULTIFUNCIONAL

9 VEZES MAIS RESISTENTES À CORROSÃO DO QUE A ZINCAGEM ELECTROLÍTICA

Na galvanização por difusão os produtos metálicos são aquecidos em fase de cozedura juntamente com pó de Zinco em contentores fechados, em rotação e a temperaturas estabilizadas entre 320 °C e 500 °C, formando-se uma forte e uniforme camada protectora Zinco-metal base.

Os produtos galvanizados por difusão são reconhecidos pela aparência cinzento escuro. A camada de Zinco distingue-se pelas propriedades multifuncionais:

- 1- Processo de difusão - ligação físico-química com o material base;
- 2- Camada uniforme - a camada protectora da mistura Zinco-material base é uniforme e ajustável, mesmo sobre produtos geometricamente complicados;
- 3- Elevada micro-dureza - até 45 HV (41 HRC), resistente ao desgaste;
- 4- Não há fragilização por Hidrogénio - neste processo é tecnicamente impossível a introdução de Hidrogénio;
- 5- Resistente a temperaturas até 600 °C - não causa a introdução líquida do zinco no metal base; estabilidade da mistura Zn-Fe;
- 6- Estrutura Micro-cristalina;
- 7- Excelente adesão - sem qualquer tratamento, de lubrificantes, compostos orgânicos, pinturas, pó e cobertura PTFE (DUPLEX-Systems);
- 8- Excelente adesão - sem qualquer pré-tratamento, de borracha;
- 9- Segurança ambiental - processo fechado, não polui a água. Passivado sem Crómio.

DESIGNAÇÃO	ROSCA	COMPRIMENTO	BROCA	CARGA DE TRABALHO [Kg] (C.SEG.>3)		ANTI-CORROSIVA
PFG M-6	M-6	40 mm	10 mm	280	50	78,00
PFG M-8	M-8	50 mm	14 mm	490	50	103,00
PFG M-10	M-10	60 mm	16 mm	780	50	138,00
PFG M-12	M-12	80 mm	20 mm	1100	25	250,00
PFG M-16	M-16	100 mm	25 mm	1880	10	450,00

BUCHA SZ PARA CARGAS ELEVADAS



BUCHA SZ

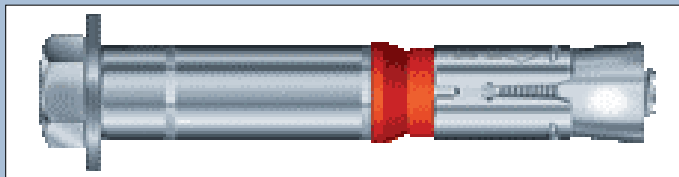

DESCRIÇÃO:

- Sistema de fixação por expansão com esforço de aperto controlado para cargas elevadas - camisa de expansão;
- Aço galvanizado para instalações internas secas;
- Fixação em betão com ou sem fissuras;
- Montagem passante;
- Cabeça: parafuso hexagonal com anilha.

APLICAÇÕES:

Fixações médias/pesadas de placas base, suportes, estantes, rails, em betão maciço ou fissurado.

MODO DE APLICAÇÃO



Tabela de Cargas (betão C25/30)

CARGA DE ROTURA	TRACÇÃO Num [kN]	CORTE Vum [kN]
M10	30,0	46,0
M12	38,8	84,7
M16 (L)	55,5 (79,8)	116,6
M20	89,4	171,0



Homologação técnica europeia - **ETA Opção 1** - com marcação **CE**.

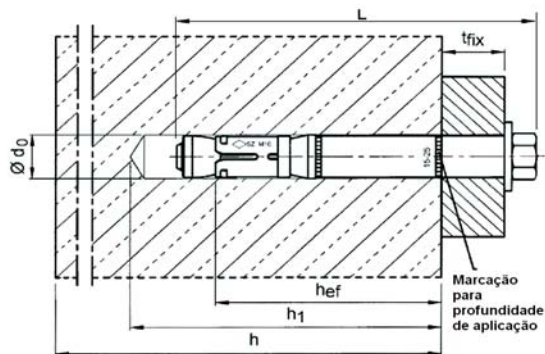

Homologação Suíça contra impactos.



M8 - M20

Adequada para sistemas de extinção de incêndios



Resistência ao fogo

Certificado segundo a Norma DIN 4102-2 (F30,F60,F90,F120) para cargas residuais nas fixações após exposição às chamas entre 30 e 120 minutos.

ROSCA	TAMANHO	BUCHA	FURO Øxh1 [mm]	PROFUND. FIXAÇÃO hef [mm]	COMPRIM. DA BUCHA L [mm]	ESPESSURA A FIXAR tfix [mm]	BINÁRIO DE APERTO [Nm]		PREÇO
M10	M10x90	SZ 15-0	15x95	85	91	0-5	50	25	270,00
	M10x105	SZ 15-15	15x95	85	106	15	50	25	280,00
	M10x115	SZ 15-25	15x95	85	116	25	50	25	300,00
	M10x130	SZ 15-45	15x95	85	136	45	50	25	350,00
	M10x180	SZ 15-95	15x95	85	186	95	50	25	440,00
M12	M12x105	SZ 18-0	18x105	95	107	0-5	80	20	420,00
	M12x115	SZ 18-10	18x105	95	117	10	80	20	430,00
	M12x130	SZ 18-20	18x105	95	127	20	80	20	450,00
	M12x150	SZ 18-40	18x105	95	147	40	80	20	550,00
	M12x180	SZ 18-70	18x105	95	177	70	80	20	700,00
M16	M16x130	SZ 24-0	24x130	120	130	0-5	160	10	800,00
	M16x150	SZ 24-20	24x130	120	150	20	160	10	900,00
	M16x180	SZ 24-30L	24x145	135	180	30	160	10	1.100,00
	M16x200	SZ 24-50L	24x145	135	200	50	160	10	1.300,00
M20	M20x170	SZ 28-10	28x160	150	172	10	280	10	1.800,00
	M20x190	SZ 28-30	28x160	150	192	30	280	10	2.000,00
	M20x220	SZ 28-60	28x160	150	222	60	280	5	2.200,00
	M20x260	SZ 28-100	28x160	150	262	100	280	5	2.600,00

BUCHA SUPERPLUS - BLS PARA CARGAS ELEVADAS



BUCHA SUPERPLUS



DESCRIÇÃO:

SUPERPLUS é uma bucha auto-bloqueante para cargas elevadas que não requer ferramentas especiais para se fixar. O design exclusivo da bucha SUPERPLUS permite criar automaticamente um rebaixo simplesmente aplicando o binário de instalação. Quando o binário é aplicado à bucha, o cone é arrastado para dentro da manga de bloqueio e os dentes de corte exteriores expandem-se e cravam-se no material base. O material da bucha é aço ao carbono de grau 8.8. A bucha SUPERPLUS tem a aprovação ETA Opção 1 e por isso é adequada, também, para o betão fissurado.

APLICAÇÕES:

Centrais elétricas, máquinas, plataformas. Aplicações interiores onde seja necessária elevada resistência à tração e ao corte.



Homologação técnica europeia - **ETA Opção 1** - com marcação **CE**.

Tabela de Cargas - Opção 1 - Método de cálculo A

BUCHA	T _{inst} [Nm]	Betão C20/25 não fissurado		Betão C20/25 fissurado	
		TRACÇÃO N _{sk} [kN]	CORTE V _{sk} [kN]	TRACÇÃO N _{sk} [kN]	CORTE V _{sk} [kN]
BLS M8-14/40/15	25	6,1	6,1	4,3	4,3
BLS M8-14/80/25	25	10,8	23,7	7,6	23,7
BLS M12-20/80/15	80	17,2	34,4	11,9	24,6
BLS M12-20/80/30	80	17,2	34,4	11,9	24,6
BLS M12-20/150/30	80	28,4	40,0	19,0	40,0
BLS M12-20/150/50	80	28,4	40,0	19,0	40,0
BLS M16-25/150/30	180	44,1	67,4	23,8	63,0
BLS M16-25/200/40	180	53,0	67,4	35,7	67,4

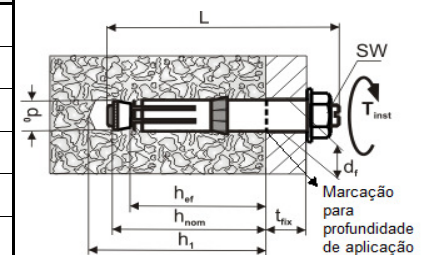

* - Preços sob consulta

ROSCA	BUCHA	FURO Øxh1 [mm]	PROFUND. FIXAÇÃO hef [mm]	COMPRIM. DA BUCHA L [mm]	ESPESSURA A FIXAR tfix [mm]		INOX-A4	ZINCADA
M8	BLS M8-14/40/15	14x60	40	80	15	25	*	948,00
	BLS M8-14/80/25	14x100	80	130	25	25	*	1.131,00
M12	BLS M12-20/80/15	20x105	80	130	15	10	*	1.867,00
	BLS M12-20/80/30	20x105	80	145	30	10	*	2.080,00
	BLS M12-20/150/30	20x175	150	215	30	10	*	2.130,00
	BLS M12-20/150/50	20x175	150	235	50	10	*	2.150,00
M16	BLS M16-25/150/30	25x185	150	220	30	10	*	2.934,00
	BLS M16-25/200/40	25x235	200	280	40	10	*	3.376,00

BUCHAS DE NYLON STANDARD



• **NYLON**

Dimensões em mm



DESIGNAÇÃO	DIÂMETRO	COMPRIMENT O DA BUCHA	BROCA	DIÂMETRO DO PARAFUSO	EMBALAGEM CAIXA		EMBALAGEM SACO	
					QUANTIDADE	PREÇO	QUANTIDADE	PREÇO
NY 4	4	20	4	2,0-3,0	200	2,35	1000	1,77
NY 5	5	25	5	2,5-4,0	200	1,43	1000	1,14
NY 6	6	30	6	3,5-5,0	100	1,84	1000	1,32
NY 8	8	40	8	4,5-6,0	100	3,26	1000	2,58
NY 10	10	50	10	6,0-8,0	50	6,17	500	4,78
NY 12	12	60	12	8,0-10,0	25	11,77	250	9,56

BUCHAS DE NYLON COM BORDO



• **NYLON**

Dimensões em mm



DESIGNAÇÃO	DIÂMETRO	COMPRIMENTO DA BUCHA	BROCA	DIÂMETRO DO PARAFUSO		PREÇO
NY 5	5	25	5	2,5-4,0	1000	1,21
NY 6	6	30	6	3,5-5,0	1000	1,40
NY 8	8	40	8	4,5-6,0	1000	2,72
NY 10	10	50	10	6,0-8,0	500	5,15

BUCHAS EM POLIETILENO DE ALTA DENSIDADE PARA TIJOLO



• **POLIETILENO HD**

Dimensões em mm

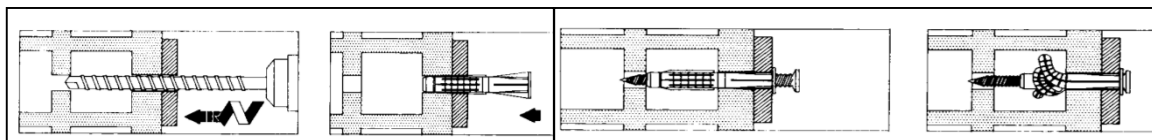

DESIGNAÇÃO	DIÂMETRO	COMPRIMENT O DA BUCHA	BROCA	PARAFUSO PZD	EMBALAGEM CAIXA		EMBALAGEM SACO	
					QUANTIDADE	PREÇO	QUANTIDADE	PREÇO
BT_NY 5	5	30	5	3x40	100	3,01	1000	1,42
BT_NY 6	6	38	6	4x50	100	3,75	1000	2,03
BT_NY 8	8	50	8	5x60	50	5,81	1000	3,38
BT_NY 10	10	60	10	6x70	25	10,67	500	5,23

BUCHA DE NYLON UNIVERSAL "T6"



(EQUIVALENTE À BUCHA "FISCHER SX")

Bucha universal indicada para todo o tipo de betão e alvenaria, desde tijolo oco e betão celular até placas leves.

- Material base - Poliamida 6;
- Gama de temperaturas: -20 °C a +40 °C;
- Cor: cinza RAL 7035.

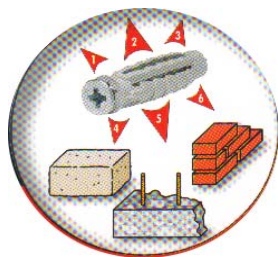

-6 zonas de expansão - elevada performance sobre materiais maciços.



-6 zonas de deformação - elevada performance sobre materiais ocos.



-Maior poder de fixação relativamente às buchas standard.

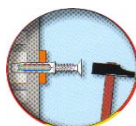

-Pode ser aplicada através do objecto a fixar, com o parafuso pré-montado.



-Pode ser usada com uma grande diversidade de parafusos.

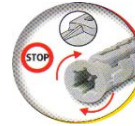

-Com alhetas anti-rotação.

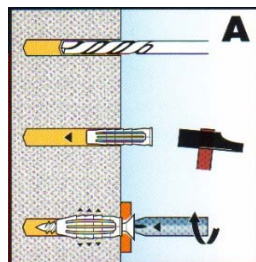

FIXAÇÃO EM MATERIAIS COMPACTOS

- 1- Fazer o furo e retirar o pó;
- 2- Inserir a bucha, colocar o objecto e fixar o parafuso;
- 3- Apertar o parafuso.

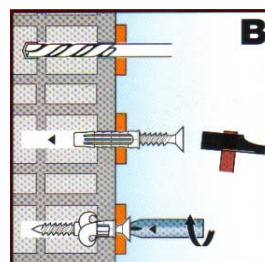

FIXAÇÃO EM MATERIAIS OCOS OU POUCO DUROS

- 1- Fazer o furo através do objecto a fixar;
- 2- Inserir a bucha e o parafuso através do objecto e fixar ;
- 3- Colocar a bucha na junta e apertar o parafuso.

TABELA DE CARGAS

Frec- Carga máxima recomendada [Kg]

Fu,m- Carga de extracção [Kg]

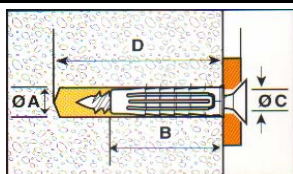

MATERIAL	T6 5x25		T6 6x30		T6 8x40		T6 10x50		T6 12x60		T6 14x70	
	Frec	Fu,m	Frec	Fu,m	Frec	Fu,m	Frec	Fu,m	Frec	Fu,m	Frec	Fu,m
BETÃO R250	60	300	70	350	116	580	158	790	220	1100	320	1600
TIJOLO MACIÇO	52	260	60	300	90	450	104	520	-	-	-	-
TIJOLO SEMI-OCO	40	200	42	210	50	250	50	250	-	-	-	-
TIJOLO OCO	20	98	20	100	22	110	22	110	-	-	-	-
BLOCO DE BETÃO OCO	48	240	50	250	64	320	68	340	103	515	108	540

ARTIGO	Ref. ^a	A (Ø BROCA) [mm]	B [mm]	C (Ø PARAFUSO) [mm]	D [mm]		PREÇO
T6 5x25	565385	5	25	3.0 - 4.0	35	100	3,49
T6 6x30	565386	6	30	4.0 - 5.0	40	100	4,04
T6 8x40	565387	8	40	4.5 - 6.0	50	100	6,44
T6 10x50	565388	10	50	6.0 - 8.0	65	50	11,77
T6 12x60	565281	12	60	8.0 - 10.0	75	25	28,00
T6 14x70	565282	14	70	10.0 - 12.0	90	25	34,00

BUCHA DE NYLON LONGA "T88"



**+30%
de resistência**

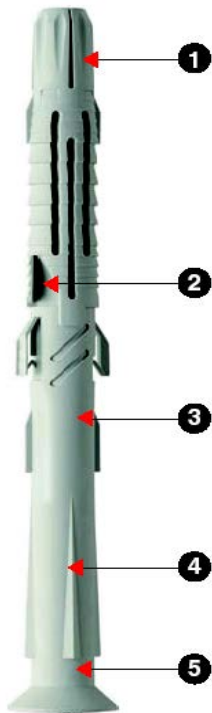

BUCHA DE NYLON - LONGA - "T88"

CARACTERÍSTICAS

- 1- Sistema duplo de fixação: expansão e deformação, inovador e patenteado. Elevada resistência em suportes ocós, +30% relativamente às buchas tradicionais graças ao seu sistema de deformação exclusiva;
- 2- Abas opostas especiais anti-rotação, concebidas para trabalhar tanto no suporte como no material a fixar;
- 3- Sistema interno de paragem do parafuso para facilitar as operações de montagem e evitar a expansão prematura durante a instalação;
- 4- O material seleccionado é poliamida de primeira categoria devidamente enriquecida com componentes químicos que asseguram o funcionamento correcto em quaisquer condições;
- 5- Com cabeça de embeber para a fixação de estruturas em madeira ou bordo plano para a conjugação com suportes metálicos.

- Material base - Poliamida 6;
- Gama de temperaturas: -20 °C a +80 °C;
- Cor: cinza RAL 7035.

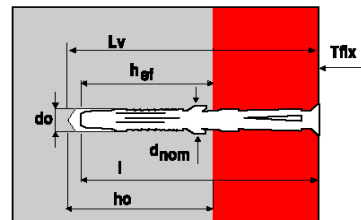

Fixação em profundidade

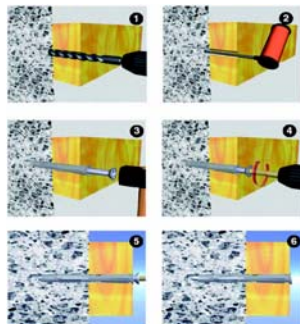

FIXAÇÃO EM MATERIAIS COMPACTOS

- 1- Fazer o furo
- 2- Retirar o pó;
- 3- Inserir a bucha, através do objecto a fixar;
- 4,5- Apertar o parafuso;
- 6- Fixação completa.

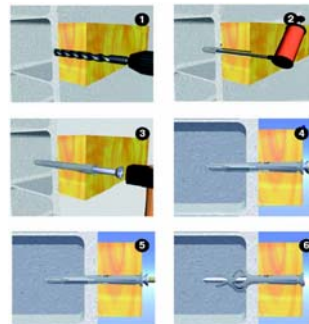

FIXAÇÃO EM MATERIAIS OCOS OU POUCO DUROS

- 1- Fazer o furo
- 2- Retirar o pó;
- 3- Inserir a bucha, através do objecto a fixar;
- 4,5- Apertar o parafuso;
- 6- Fixação completa.

ARTIGO	Ref. ^a	d0	l=hef	h0	hmin	Tfix	l	dv		PREÇO
T88 8x80	566730	8	70	85	140	10	80	6	100	9,42
T88 8x100	566731	8	70	85	140	30	100	6	50	12,55
T88 8x120	566732	8	70	85	140	50	120	6	50	14,12
T88 10x80	566739	10	70	85	140	10	80	7	50	15,69
T88 10x100	566740	10	70	85	140	30	100	7	50	17,78
T88 10x115	566741	10	70	85	140	45	115	7	50	19,35
T88 10x145	566742	10	70	85	140	75	145	7	50	21,97
T88 10x160	566743	10	70	85	140	90	160	7	50	25,63
T88 10x185	566744	10	70	85	140	115	185	7	50	28,25
T88 10x210	566745	10	70	85	140	140	210	7	50	31,23
T88 12x120	566760	12	70	85	140	50	120	9	25	37,66
T88 12x145	566761	12	70	85	140	75	145	9	25	40,28
T88 12x165	566762	12	70	85	140	95	165	9	25	43,42
T88 12x185	566763	12	70	85	140	115	185	9	25	46,03
T88 12x210	566764	12	70	85	140	140	210	9	25	50,74
T88 16x145	566780	16	90	115	180	55	145	12	25	57,54
T88 16x165	566781	16	90	115	180	75	165	12	25	62,77
T88 16x185	566782	16	90	115	180	95	185	12	25	71,14
T88 16x200	566783	16	90	115	180	110	200	12	25	74,28
T88 16x270	566784	16	90	115	180	180	270	12	25	92,06

BUCHA DE NYLON LONGA "T88" COM PARAFUSO



Fixação em profundidade

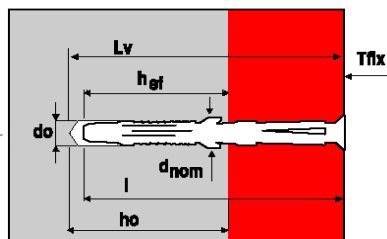

+30%
de resistência

COM PARAFUSO TORX CABEÇA DE EMBEBER - T88/V Torx

ARTIGO	Ref. ^a	d0	l=hef	h0	hmin	Tfix	l	dv		PREÇO
T88/V 8x80 TX	567001	8 (TX30)	70	85	140	10	80	6x85	50	17,13
T88/V 8x100 TX	567002	8 (TX30)	70	85	140	30	100	6x105	50	20,11
T88/V 8x120 TX	567003	8 (TX30)	70	85	140	50	120	6x125	50	25,73
T88/V 10x80 TX	567004	10 (TX40)	70	85	140	10	80	7x85	50	25,45
T88/V 10x100 TX	567005	10 (TX40)	70	85	140	30	100	7x105	50	29,67
T88/V 10x115 TX	567006	10 (TX40)	70	85	140	45	115	7x120	50	37,30
T88/V 10x145 TX	567007	10 (TX40)	70	85	140	75	145	7x150	50	44,70
T88/V 10x160 TX	567008	10 (TX40)	70	85	140	90	160	7x165	50	50,70
T88/V 10x185 TX	567009	10 (TX40)	70	85	140	115	185	7x190	50	58,50
T88/V 10x210 TX	567010	10 (TX40)	70	85	140	140	210	7x215	50	65,34

COM PARAFUSO TIREFOND (DIN 571) - T88/V TE

ARTIGO	Ref. ^a	d0	l=hef	h0	hmin	Tfix	l	dv		PREÇO
T88/V 8x80 TE	566733	8 (Ch10)	70	85	140	10	80	6x85	50	27,44
T88/V 8x100 TE	566734	8 (Ch10)	70	85	140	30	100	6x105	50	33,91
T88/V 8x120 TE	566735	8 (Ch10)	70	85	140	50	120	6x125	50	37,42
T88/V 10x80 TE	566746	10 (Ch13)	70	85	140	10	80	7x85	50	41,15
T88/V 10x100 TE	566747	10 (Ch13)	70	85	140	30	100	7x105	50	43,90
T88/V 10x115 TE	566748	10 (Ch13)	70	85	140	45	115	7x120	50	50,54
T88/V 10x145 TE	566749	10 (Ch13)	70	85	140	75	145	7x150	50	57,62
T88/V 10x160 TE	566750	10 (Ch13)	70	85	140	90	150	7x165	50	71,33
T88/V 10x185 TE	566751	10 (Ch13)	70	85	140	115	185	7x190	50	82,31
T88/V 10x210 TE	566752	10 (Ch13)	70	85	140	140	210	7x215	50	87,79
T88/V 12x120 TE	566765	12 (Ch17)	70	90	140	50	120	9x130	25	158,03
T88/V 12x145 TE	566766	12 (Ch17)	70	90	140	75	145	9x155	25	165,93
T88/V 12x165 TE	566767	12 (Ch17)	70	90	140	95	165	9x175	25	203,41
T88/V 12x185 TE	566768	12 (Ch17)	70	90	140	115	185	9x190	25	219,05
T88/V 12x210 TE	566769	12 (Ch17)	70	90	140	140	210	9x220	25	234,69
T88/V 16x145 TE	566785	16 (Ch19)	90	115	180	55	145	12x160	25	361,93
T88/V 16x165 TE	566786	16 (Ch19)	90	115	180	75	165	12x180	25	372,58
T88/V 16x185 TE	566787	16 (Ch19)	90	115	180	95	185	12x200	25	399,19
T88/V 16x200 TE	566788	16 (Ch19)	90	115	180	110	200	12x215	25	420,48
T88/V 16x270 TE	566789	16 (Ch19)	90	115	180	180	270	12x285	15	452,42

BORDO PLANO COM PARAFUSO SEXTAVADO FENDA TORX - T88/V TER W

ARTIGO	Ref. ^a	d0	l=hef	h0	hmin	Tfix	l	dv		PREÇO
T88/V 14x120 TER W	566775	14	80	105	160	50	120	10x130	25	194,30
T88/V 14x145 TER W	566776	14	80	105	160	75	145	10x155	25	210,27
T88/V 14x165 TER W	566777	14	80	105	160	95	165	10x175	25	260,81
T88/V 14x185 TER W	566778	14	80	105	160	115	185	10x190	25	344,21
T88/V 14x210 TER W	566779	14	80	105	160	140	210	10x220	25	408,41

TAPITS
CABEÇA PLANA

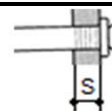
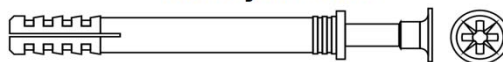

• NYLON CINZENTO

S- Espessura máxima do material a fixar

DIÂMETRO (mm)	DESIGNAÇÃO	COMP. TOTAL (mm)	DIÂM. DO FURO (mm)	S (mm)	INOX-A2			ZINCADO		
							PREÇO			PREÇO
Ø5	5x25	25	5	3				200	4800	6,10
	5x30	30	5	5				200	4800	6,20
	5x35	35	5	5				100	2400	6,30
	5x40	40	5	5				100	2400	6,60
	5x45	45	5	10				100	2400	6,90
	5x50	50	5	10				100	2400	7,30
Ø6	6x35	35	6	5	100		28,00	100	2400	6,20
	6x40	40	6	10	100		26,00			
	6x45	45	6	15				100	2400	7,30
	6x50	50	6	20	200		35,00			
	6x55	55	6	25				100	2000	7,90
	6x60	60	6	30	100		35,00	100	2000	8,30
	6x70	70	6	40				50	1200	9,10
Ø8	8x60	60	8	15	100		65,00	50	1200	14,20
	8x75	75	8	30				50	1200	17,40
	8x80	80	8	35	100		70,00	50	1200	17,60
	8x100	100	8	60	100		94,00	50	1200	23,70
	8x120	120	8	80				50	1000	26,70
	8x135	135	8	95				50	1000	29,60

TAPITS
CABEÇA CÔNICA

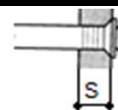
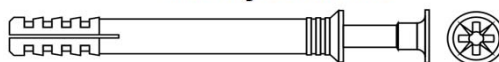

• NYLON CINZENTO

S- Espessura máxima do material a fixar

DIÂMETRO (mm)	DESIGNAÇÃO	COMP. TOTAL (mm)	DIÂM. DO FURO (mm)	S (mm)	INOX-A2			ZINCADO		
							PREÇO			PREÇO
Ø4	4x35	35	4	10				100	2400	6,00
Ø5	5x25	25	5	3				200	4800	5,20
	5x30	30	5	5				200	4800	5,40
	5x35	35	5	6				100	2400	5,60
	5x40	40	5	8				100	2400	5,70
	5x45	45	5	10				100	2400	6,50
	5x50	50	5	12				100	2400	6,80
Ø6	6x35	35	6	5			20,00	100	2400	5,40
	6x40	40	6	10	100		20,00	100	2400	6,10
	6x45	45	6	15				100	2400	6,30
	6x50	50	6	20	200		28,00	100	2000	8,00
	6x55	55	6	25				100	2000	8,10
	6x60	60	6	30	100		30,00	100	2000	8,40
	6x70	70	6	40				50	1200	9,90
Ø8	8x60	60	8	15	100		40,00	50	1200	13,70
	8x75	75	8	30				50	1200	15,80
	8x80	80	8	35	50		50,00	50	1200	15,80
	8x100	100	8	60	50		60,00	50	1200	21,20
	8x120	120	8	80	100		80,00	50	1000	25,40
	8x135	135	8	95				40	800	29,40
Ø10	10x80	80	10	30				25	450	35,00
	10x100	100	10	60				25	450	38,00
	10x120	120	10	75				20	240	45,00
	10x140	140	10	95				20	220	50,00
	10x160	160	10	115				20	200	60,00

TAPIT DE CABEÇA ROSCADA



• NYLON



Dimensões em mm

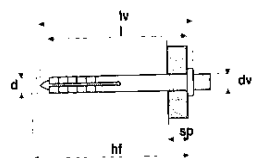

DESIGNAÇÃO	dv	L	D	sp		PREÇO
M-6x35	M-6	35	6	5	100	12,47
M-7x35	M-7	35	6	5	100	12,47
M-7x60	M-7	57	8	30	50	17,46
M-8x60	M-8	57	8	15	50	17,46

BUCHAS PARA CAIXILHARIA



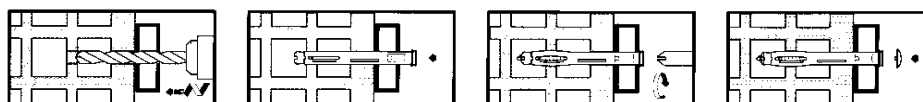

• NYLON

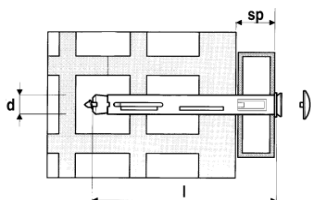

Dimensões em mm

Dimensões em mm



DESIGNAÇÃO	L	d	sp		PREÇO
8x75	75	8	25	50	27,43
8x100	100		50	50	29,93
8x120	120		70	50	34,92
8x140	140		90	50	39,90
10x75	75	10	15	50	32,42
10x100	100		40	50	37,41
10x120	120		60	50	42,40
10x140	140		80	50	49,49
10x160	160		100	50	54,87
TAMPAS	Cores: cinzento, preto, branco				3,49

BUCHAS DE NYLON STANDARD SEM BORDO



• POLIAMIDA 6

Dimensões em mm



DESIGNAÇÃO	Ø	L	Ø BROCA	Ø PARAFUSO	EMBALAGEM CAIXA			EMBALAGEM SACO		
							PREÇO			PREÇO
4x20	4	20	4	2,0-3,0	200	42000	0,98	1000	100000	0,75
5x25	5	25	5	2,5-4,0	200	42000	0,98	1000	70000	0,86
6x30	6	30	6	3,5-5,0	100	21000	1,08	1000	38000	0,90
8x40	8	40	8	4,5-6,0	100	10500	2,11	1000	18000	1,73
10x50	10	50	10	6,0-8,0	50	5250	3,98	500	9000	3,65
12x60	12	60	12	8,0-10,0	25	2625	8,90	250	5500	7,00
14x75	14	75	14	10,0-12,0	20	2100	13,00	200	3000	12,00

BUCHAS DE NYLON STANDARD COM BORDO



• POLIAMIDA 6

Dimensões em mm



DESIGNAÇÃO	Ø	L	Ø BROCA	Ø PARAFUSO	EMBALAGEM CAIXA			EMBALAGEM SACO		
							PREÇO			PREÇO
5x25	5	25	5	2,5-4,0	200	42000	0,98	1000	60000	0,89
6x30	6	30	6	3,5-5,0	100	21000	1,08	1000	34000	0,95
8x40	8	40	8	4,5-6,0	100	10500	2,11	1000	16000	1,82
10x50	10	50	10	6,0-8,0	50	5250	3,98	500	8000	3,85
12x60	12	60	12	8,0-10,0	25	2625	8,90	250	5500	7,50

BUCHA DE NYLON UNIVERSAL



CARATERÍSTICAS

Bucha universal indicada para todo o tipo de betão e alvenaria, desde tijolo oco e betão celular até placas leves.

Em materiais maciços a fixação dá-se por pressão interna contra as paredes do furo.

Em materiais ocós a fixação dá-se por deformação tipo nó nos segmentos atrás da face da parede.

- Material base - Poliamida 6;
- Gama de temperaturas: -40 °C a +100 °C;
- Cor: cinza RAL 7035.



APLICAÇÕES:

- Tijolo maciço ou oco;
- Betão;
- Arenito;
- Aglomerado;
- Gesso cartonado.

VANTAGENS:

- Alta qualidade;
- Instalação rápida;
- Aplicação em inúmeros materiais.

TABELA DE CARGAS [kN]

ARTIGO	Cargas rec. (betão)
5x25	0,40
6x30	0,70
8x40	0,80
10x50	1,40

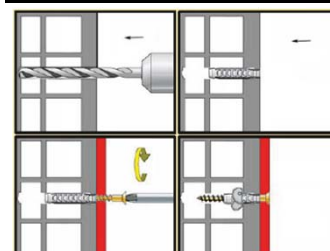

ARTIGO	Ø BROCA	PROFUNDIDADE MÍNIMA DO FURO	COMPRIMENTO DA BUCHA	Ø PARAFUSO [mm]			PREÇO
5x25	5	35	25	3.0 - 4.0	200	42000	1,50
6x30	6	40	30	4.0 - 5.0	100	21000	1,58
8x40	8	50	40	4.5 - 6.0	100	10500	3,04
10x50	10	70	50	6.0 - 8.0	50	5250	5,88

TAPITS PARA TECTOS FALSOS



• **NYLON BRANCO**

S- Espessura máxima do material a fixar

EMBALAGEM	DESIGNAÇÃO	COMP. TOTAL (mm)	DIÂM. DO FURO (mm)	S (mm)	INOX-A2			ZINCADO		
							PREÇO			PREÇO
SACO	TAPIT 25	25	6	5				1000		2,88
	TAPIT 37	37	6	10				500		4,32
	TAPIT 50	50	6	20				500		5,95
CAIXA	TAPIT 25	25	6	5				100		3,55
	TAPIT 37	37	6	10				50		5,38
	TAPIT 50	50	6	20				50		7,49
	TAPIT 75	75	6	35				25		12,48

BUCHA LONGA EM NYLON - SIMPLES - COM PARAFUSO TORX - - COM PARAFUSO SEXTAVADO -



• **NYLON CINZENTO (Poliamida 6)**

Bucha para caixilharia

As buchas para caixilharia têm uma longa área de expansão e são adequadas para fixações passantes nas cavidades dos tijolos, etc.

O desenho interior especial e a área de expansão longa proporcionam fixações seguras em betão, pedra e materiais macios, como tijolo e blocos de baixa densidade.

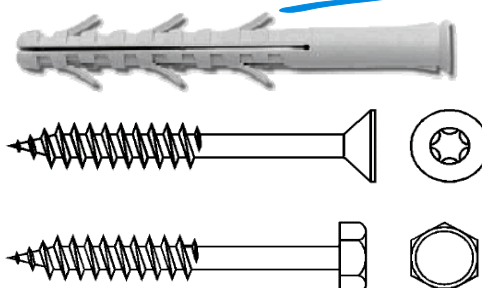

APLICAÇÕES:

- Caixilharia;
- Tijolo oco;
- Betão;
- Pedra.

VANTAGENS:

- Fixação resistente;
- Resistente a altas temperaturas;
- Instalação fácil;
- Pack completo.

Tamanho	Profundidade mínima do furo	Ø Parafuso	Cargas recomendadas [kN]
8x80	90	5 - 5,5	0,75
8x100	110	5 - 5,5	0,75
8x120	130	5 - 5,5	0,75
10x80	90	6 - 7	0,92
10x100	110	6 - 7	0,92
10x120	130	6 - 7	0,92
10x140	150	6 - 7	0,92
10x160	170	6 - 7	0,92

Instalação

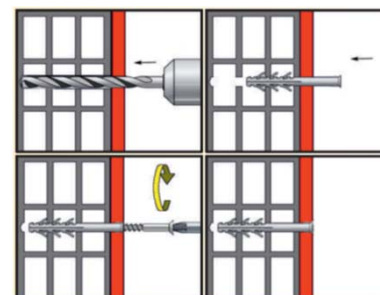

S- Espessura máxima do material a fixar

Ø (mm)	DESIGNAÇÃO	COMP. TOTAL (mm)	Ø FURO (mm)	S (mm)	COM PARAFUSO SEXTAVADO ZINCADO			COM PARAFUSO TORX ZINCADO			SIMPLES EM NYLON		
							PREÇO			PREÇO			PREÇO
Ø8	8x80	80	8	15	50	1000	25,92	50	1000	21,60	100	2000	8,06
	8x100	100	8	35	25	600	31,68	25	600	27,36	50	1200	9,94
	8x120	120	8	55	25	600	38,88	25	600	34,56	50	1200	12,24
Ø10	10x80	80	10	15	25	500	40,32	25	500	36,00	50	1000	12,24
	10x100	100	10	35	25	500	46,08	25	500	40,32	25	600	14,83
	10x120	120	10	55	20	400	54,72	20	400	48,96	25	600	17,71
	10x140	140	10	75	20	400	66,24	20	400	57,60	25	500	20,30
	10x160	160	10	95	20	400	83,52	20	400	74,88	25	500	22,90

Edição: 1/2006
Data: Setembro 2006

Revisão: 7
Data: 4 de setembro 2023

Preço: €100

TABELA 7.10 D

**BUCHAS EM NYLON
COM TACO EXPANSOR EM METAL**



• NYLON • COM CAMARÃO • COM OLHAL • COM ESCÁPULA

Dimensões em mm

TIPO	DESIGNAÇÃO	COMPRIMENTO DA BUCHA	ROSCA	DIÂMETRO DO FURO		PREÇO
	BN CAMARÃO M-4	42	M-4	9	50	22,45
	BN CAMARÃO M-5	42	M-5	12	50	34,92
	BN OLHAL M-4	42	M-4	9	50	22,45
	BN OLHAL M-5	42	M-5	12	50	34,92
	BN ESCÁPULA M-4	42	M-4	9	100	19,95
	BN ESCÁPULA M-5	42	M-5	12	50	29,93

**BUCHAS EM AÇO
COM TACO EXPANSOR EM METAL**



• AÇO • COM CAMARÃO • COM OLHAL • COM ESCÁPULA

Dimensões em mm

TIPO	DESIGNAÇÃO	COMPRIMENTO DA BUCHA	ROSCA	DIÂMETRO DO FURO		PREÇO
	M-4 CAMARÃO	45	M-4	8	50	22,45
	M-5 CAMARÃO	50	M-5	10	50	29,93
	M-4 OLHAL	45	M-4	8	50	22,45
	M-5 OLHAL	50	M-5	10	50	29,93
	M-4 ESCÁPULA	45	M-4	8	100	19,95
	M-5 ESCÁPULA	50	M-5	10	50	22,45

BUCHAS PARA CAPOTO

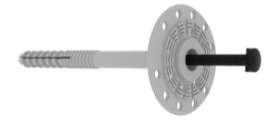

• COPOLÍMERO • NYLON + FIBRA DE VIDRO

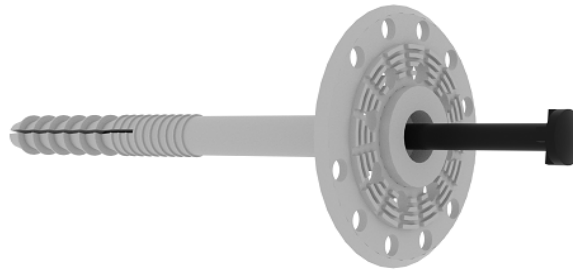

PARAFAST

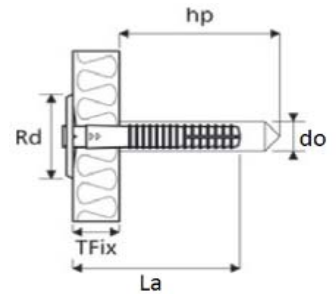

CARATERÍSTICAS:

- Bucha para uso geral em placas de isolamento duras e macias.
- Bucha especial usada para fixação de material de isolamento.
- A bucha é facilmente instalada apenas com um martelo.
- Alta resistência às condições atmosféricas.

Cargas recomendadas:

- Betão: 0,187 kN;
- Tijolo: 0,150 kN.

Para todos os tipos de placas de isolamento

APLICAÇÕES:

- Betão.
- Tijolo maciço.
- Pedra.
- Tijolo oco.

VANTAGENS:

- Fácil instalação.
- Instalação rápida.
- Económica.
- Não existe ponte térmica.

MATERIAL:

- Bucha: Copolímero.
- Prego: Poliamida (Nylon) com fibra de vidro.

INSTALAÇÃO

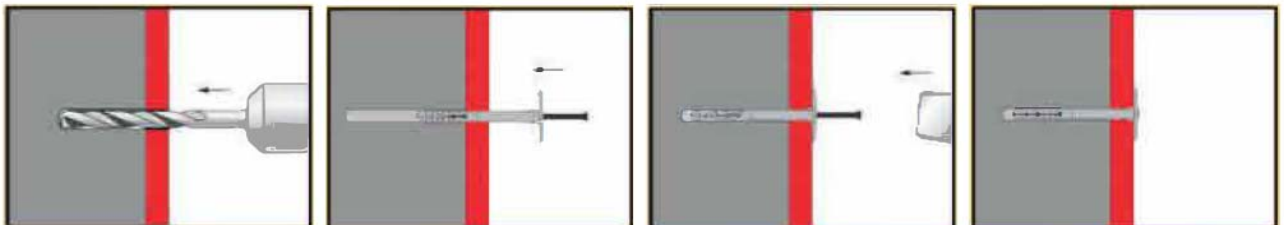

Dimensões em mm

DESIGNAÇÃO	COMPRIENTO La	DIÂMETRO DA BUCHA do	Rd	ESPESSURA MATERIAL A FIXAR Tfix		PREÇO
ISO 50/70	70	10	50	20-40	250	15,50
ISO 10/60-90	90	10	60	40-60	200	15,00
ISO 10/60-110	110	10	60	70-80	200	17,00
ISO 10/60-130	130	10	60	90-100	200	18,00
ISO 10/60-150	150	10	60	110-120	200	21,00
ISO 10/60-180	180	10	60	130-140	200	27,00

BUCHAS METÁLICA PARA CAIXILHARIA



PARAFAST

• **ZINCADO**



APLICAÇÕES

ADEQUADO PARA:

Betão, tijolo maciço, tijolo areado maciço, tijolo perfurado, tijolo areado perfurado, pedra pomes, pedra natural.

PARA FIXAR:

Caixilhos de janelas e portas feitos de metal, madeira, plástico, etc...

DADOS TÉCNICOS

- Parafuso M6 zincado;
- Cabeça chata Ø 13 mm;
- Fenda pozidrive PZD n.º 3;
- Corpo expansivo com alhetas anti-rotação.



TABELA DE CARGAS [KN]

MATERIAL BASE	Rec	Rot
Betão ≥ B25	1,38	5,5
Tijolo maciço ≥ Mz 12	1,28	5,1
Tijolo areado maciço ≥ Ks 12	1,28	5,1
Tijolo de betão maciço ≥ V2	0,48	1,8
Tijolo areado perfurado ≥ KSL 6	0,55	2,2

Carga Recomendada- Rec

Carga de Rotura- Rot

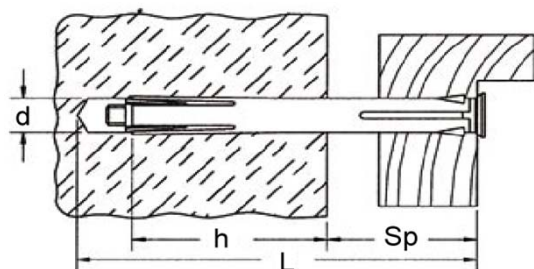
DIAGRAMA DE INSTALAÇÃO

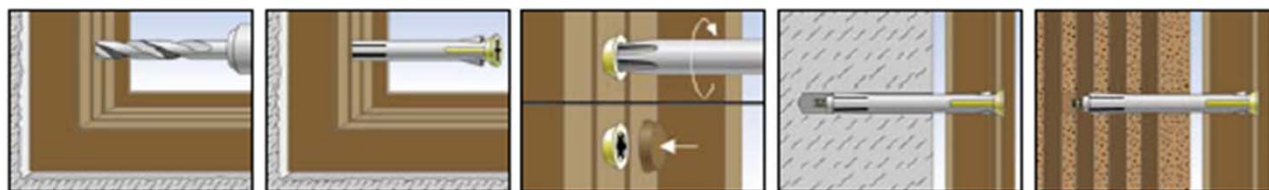

Dimensões em mm

DESIGNAÇÃO	PARAFUSO	Ø FURO (d)	L (min)	h (min)	Sp (max)		PREÇO
M10x72	M6x88	10	90	30	42	100	21,60
M10x92	M6x108	10	110	30	62	100	24,80
M10x112	M6x128	10	130	30	82	100	28,90
M10x132	M6x148	10	150	30	102	100	33,50
M10x152	M6x168	10	170	30	122	100	41,20
M10x182	M6x198	10	200	30	152	100	47,70

BUCHAS DE NYLON HAV PARA PLACAS DE GESSO CARTONADO



• NYLON

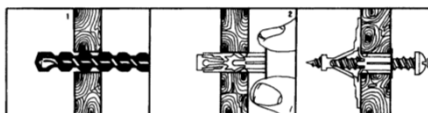

Dimensões em mm

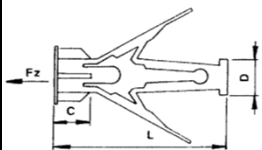

DESIGNAÇÃO	L	BROCA D	PARAFUSO	ESPESSURA DA PLACA		PREÇO
HAV - 10x38	38	10	4,5x40	4-12	100	8,30
HAV - 10x47	47	10	4,5x50	13-18	100	9,50

BUCHAS AUTO-PERFURANTES PARA GESSO CARTONADO



• ZAMAK • NYLON

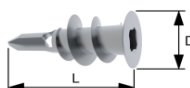

Dimensões em mm

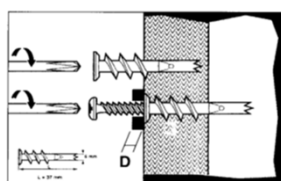

DESIGNAÇÃO	MATERIAL	L	D	PARAFUSO DIN 7981 (placa 0-12)		PREÇO
HZK	ZAMAK	37	13	4,2x38	250	14,00
HZN	NYLON	37	14	4,2x38	250	8,30

BUCHAS DE MOLA EM AÇO ZINCADO



• AÇO ZINCADO • SIMPLES • COM PERNO • COM GANCHO • COM OLHAL



SIMPLES



COM PERNO



COM GANCHO



COM OLHAL

Dimensões em mm



DESIGNAÇÃO	MEDIDA		PREÇO
BM M-6 (SIMPLES)	M-6	100	15,00
BM GANCHO	M-5x81	100	25,00
	M-4x100	100	25,00
	M-5x75	100	25,00
BM OLHAL	M-6x60	100	25,00
	M-5x90	100	25,00

BUCHAS DE BASCULAR EM AÇO ZINCADO



• AÇO ZINCADO • SIMPLES • COM PERNO • COM GANCHO • COM OLHAL



SIMPLES



COM PERNO



COM GANCHO



COM OLHAL

Dimensões em mm

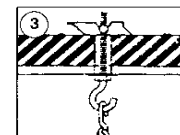
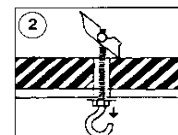
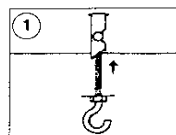

DESIGNAÇÃO	MEDIDA		PREÇO
BB M-6 (SIMPLES)	M-6	100	22,45
BB PERNO	M-6x100	100	25,00
BB GANCHO	M-6x102	100	25,00
BB OLHAL	M-6x102	100	25,00

BUCHAS GUARDA-CHUVA PARA CAVIDADES



• AÇO ZINCADO

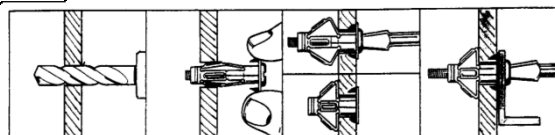

Dimensões em mm



DESIGNAÇÃO	COMPRIMENTO	DIÂMETRO DA BUCHA	BROCA	ESPESSURA MATERIAL A FIXAR		PREÇO
M-4x32	32	6,5	8	3-12	100	8,90
M-4x38	38	6,5	8	10-16	100	9,30
M-4x45	45	6,5	8	16-22	100	11,80
M-4x54	54	6,5	8	24-30	100	13,70
M-5x37	37	8,5	10	6-13	100	14,90
M-5x52	52	8,5	10	10-16	100	16,30
M-5x65	65	8,5	10	14-32	100	18,30
M-5x80	80	8,5	10	20-45	50	22,50
M-6x37	37	10,5	12	6-13	100	17,10
M-6x52	52	10,5	12	10-16	100	18,50
M-6x65	65	10,5	12	14-32	100	21,90
M-6x80	80	10,5	12	20-45	50	25,20

OLHAL E CAMARÃO PARA BUCHAS GUARDA-CHUVA



• AÇO ZINCADO



DESIGNAÇÃO	COMPRIMENTO				PREÇO
OLHAL PARA BUCHA GUARDA-CHUVA 	M-4x39	39		100	6,00
	M-5x75	75		100	10,80
	M-6x60	60		100	13,20
CAMARÃO PARA BUCHA GUARDA-CHUVA 	M-4x39	39		100	6,00
	M-5x60	60		100	8,40
	M-6x60	60		100	12,00

ALICATE PARA EXPANDIR BUCHAS GUARDA-CHUVA HT - 01

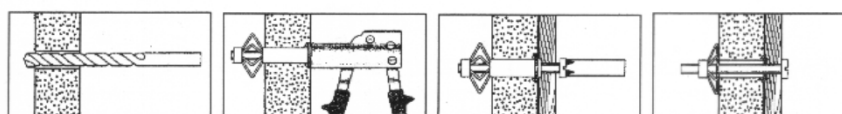

CARATERÍSTICAS:
 • Ferramenta em metal;
 • Qualidade profissional.

DESIGNAÇÃO	PREÇO/Unid.
ALICATE PARA BUCHAS GUARDA-CHUVA	22,00

GANCHO ESTAMPADO A FRIO



• AÇO ZINCADO

• AÇO INOX-A2

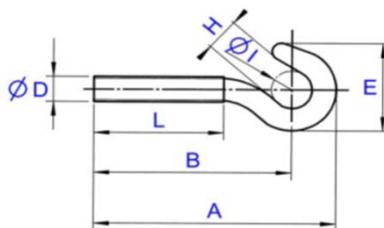

Dimensões em mm

DESIGNAÇÃO	L	A	B	E	H	ØI	Kg/1000	INOX-A2	ZINCADO
GANCHO M-5	48,0	71,5	63,0	17,5	6,0	7,5	9,6		28,00
GANCHO M-6	55,0	82,0	70,5	22,5	8,0	9,5	16,2	140,00	31,00
GANCHO M-8	60,0	98,0	83,5	30,0	10,0	11,0	36,0	240,00	45,00
GANCHO M-10	73,0	116,5	100,5	36,0	12,5	14,0	67,0	400,00	70,00
GANCHO M-12	90,0	146,0	125,5	47,0	16,0	18,0	124,5	750,00	150,00
GANCHO M-16	100,0	175,0	150,0	58,0	19,0	20,0	275,0		400,00

OLHAL ESTAMPADO A FRIO



• AÇO ZINCADO

• AÇO INOX-A2

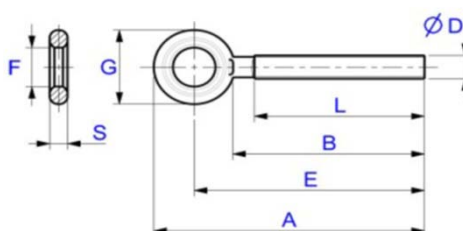

Dimensões em mm

DESIGNAÇÃO	L	B	A	E	G		F		S		Kg /1000	INOX-A2	ZINCADO
					Min	Máx	Min	Máx	Min	Máx			
OLHAL M-5	48,0	50,0	67,5	57,7	15,3	16,7	8,05	8,55	3,20	3,80	8,9		28,00
OLHAL M-6	55,0	60,0	79,6	69,6	18,3	19,7	9,75	10,25	3,90	4,50	15,4		31,00
	55,0	60,5	80,0	70,0	19,2	20,8	9,70	10,30	5,20	5,80	17,9	180,00	
OLHAL M-8	60,0	65,0	86,7	75,4	21,8	23,2	11,55	12,05	4,90	5,50	29,6		45,00
	60,0	66,5	88,0	77,0	21,2	22,8	10,70	11,30	6,00	6,60	32,2	250,00	
OLHAL M-10	73,0	81,0	107,1	93,6	26,0	28,0	14,25	14,75	6,15	6,85	58,0		70,00
	73,0	80,0	110,0	94,5	30,0	32,0	13,60	14,40	8,20	9,00	72,0	450,00	
OLHAL M-12	90,0	98,0	130,3	113,5	32,5	34,5	16,75	17,25	8,15	8,85	103,6		150,00
	90,0	97,5	131,0	113,5	34,0	36,0	15,60	16,40	8,60	9,40	110,8	750,00	
OLHAL M-16	95,0	100,0	145,3	122,1	44,8	47,2	22,70	23,30	12,10	12,90	228,5		400,00

**DISPOSITIVO DE FIXAÇÃO RÁPIDA
PARA TECTOS FALSOS
- PERFIL HORIZONTAL - DE ROSCAR -**

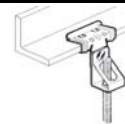

• FOSFATADO • PARA VARÃO ROSCADO M6

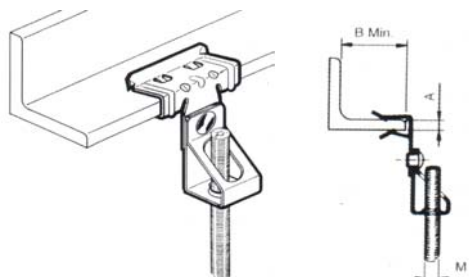

Ref. ^a	DIMENSÕES (mm)				PREÇO
	A	B	M		
100-210	1,5-4	18	M6	100	110,00
101-210	4-10	25	M6	100	135,00

**DISPOSITIVO DE FIXAÇÃO RÁPIDA
PARA TECTOS FALSOS
- PERFIL HORIZONTAL - DE MOLA -**

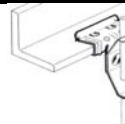

• FOSFATADO • PARA VARÃO ROSCADO M6 OU VARÃO LISO Ø6

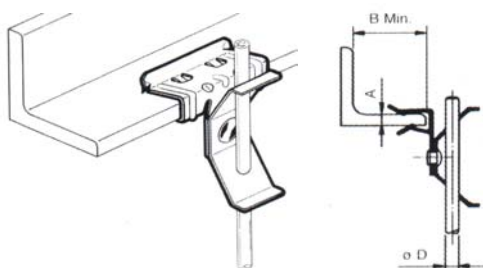

Ref. ^a	DIMENSÕES (mm)				PREÇO
	A	B	Ø D		
100-221	1,5-4	18	6	100	80,00
101-221	4-10	25	6	100	110,00

**DISPOSITIVO DE FIXAÇÃO RÁPIDA
PARA TECTOS FALSOS
- PERFIL VERTICAL - DE ROSCAR -**

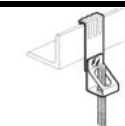

• FOSFATADO • PARA VARÃO ROSCADO M6

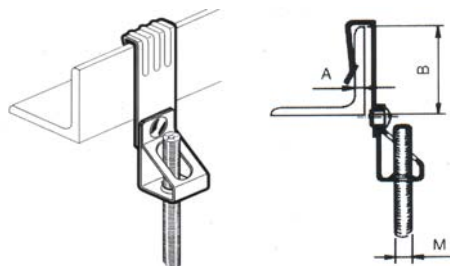

Ref. ^a	DIMENSÕES (mm)				PREÇO
	A	B	M		
110-210	1,5-5	30	M6	100	115,00
111-210	5-7	30	M6	100	115,00

**DISPOSITIVO DE FIXAÇÃO RÁPIDA
PARA TECTOS FALSOS
- PERFIL VERTICAL - DE MOLA -**

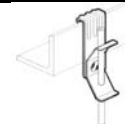

• FOSFATADO • PARA VARÃO ROSCADO M6 OU VARÃO LISO Ø6

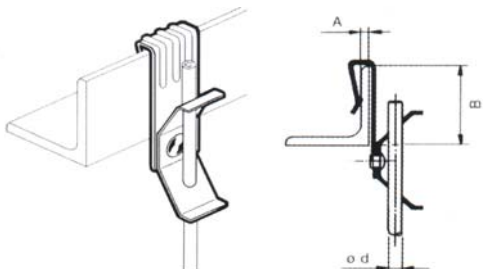

Ref. ^a	DIMENSÕES (mm)				PREÇO
	A	B	Ø d		
110-221	1,5-5	30	6	100	85,00
111-221	5-7	30	6	100	85,00

ABRAÇADEIRAS DE FIVELA EM POLIAMIDA 6.6

• POLIAMIDA 6.6



POLIAMIDA 6.6 - CARACTERÍSTICAS DA MATÉRIA PRIMA

Absorção de humidade: 2,5% (50% humidade relativa)

Temperatura de trabalho: -40°C a +85°C

Temperatura de aplicação: -10°C a +60°C

Ponto máximo admissível: +110°C por um curto período

Temperatura de fusão: +256°C

Índice limite de oxigénio: 27%

Taxa de inflamabilidade: UL 94 classe V2

Resistência dielétrica: 50 000 volts/mm



Resistência ao meio ambiente:

- Elevada resistência às bases, óleos, massas, derivados do petróleo, solventes clorídricos;
- Resistência limitada aos ácidos;
- Não resistente aos fenóis;
- Resinas livres de halogéneos.

PRETO

BRANCO

VERMELHO

AMARELO

VERDE

AZUL

RAL 3000

RAL 1021

RAL 6032

RAL 5010

Dimensões em mm

TAMANHO	LARGURA (novas medidas)	COMPRIM. (novas medidas)	ATADO		RESISTÊNCIA À TRACÇÃO [Kg] ([N])		PREÇO	
			Ø mín.	Ø máx.			CORES	PRETO/ BRANCO
2,5x98	2,5	98	1	21	8.16 (80)	100	1,58	0,77
2,6x135	2,6 (2,5)	135	1	32	8.16 (80)	100		1,40
2,6x160	2,6	160	1	40	8.16 (80)	100		1,83
2,6x200	2,6	200	1	52	8.16 (80)	100		1,98
3,6x140	3,6 (3,5)	140	2	35	13.26 (130)	100	2,90	1,77
3,6x200	3,6 (3,5)	200	2	50	13.26 (130)	100	3,96	2,50
3,6x290	3,6 (3,5)	290	2	80	13.26 (130)	100		3,76
4,8x178	4,8	178	3	45	22.44 (220)	100		3,25
4,8x200	4,8 (4,5)	200	3	50	22.44 (220)	100	5,54	3,25
4,8x290	4,8 (4,5)	290	3,5	79	22.44 (220)	100	7,92	4,86
4,8x360	4,8 (4,5)	360	3,5	103	22.44 (220)	100		6,08
7,8x240	7,8 (7,5)	240	3,5	63	55.08 (540)	100		9,68
7,8x365	7,8 (7,5)	365	8	100	55.08 (540)	100		13,09
7,8x540	7,8 (7,5)	540	35	158	55.08 (540)	100		25,34
7,8x750	7,8 (7,5)	750	35	220	55.08 (540)	100		38,59

Edição: 1/2006

Data: Setembro 2006

Revisão: 6

Data: 8 de novembro 2021

Preço: €100

TABELA 7.16

ABRAÇADEIRAS DE FIVELA EM POLIAMIDA 6.6



• POLIAMIDA 6.6



Halogen
Free

Type 11
®
E75050-18T1

POLIAMIDA 6.6 - CARACTERÍSTICAS DA MATÉRIA PRIMA

Absorção de humidade: 2,5% (50% humidade relativa)

Temperatura de trabalho: -40°C a +85°C
 Temperatura de aplicação: -10°C a +60°C
 Ponto máximo admissível: +110°C por um curto período
 Temperatura de fusão: +256°C
 Índice limite de oxigénio: 27%
 Taxa de inflamabilidade: UL 94 classe V2
 Resistência dielétrica: 50 000 volts/mm

Resistência ao meio ambiente:

- Elevada resistência às bases, óleos, massas, derivados do petróleo, solventes clorídricos;
- Resistência limitada aos ácidos;
- Não resistente aos fenois;
- Resinas livres de halogéneos.

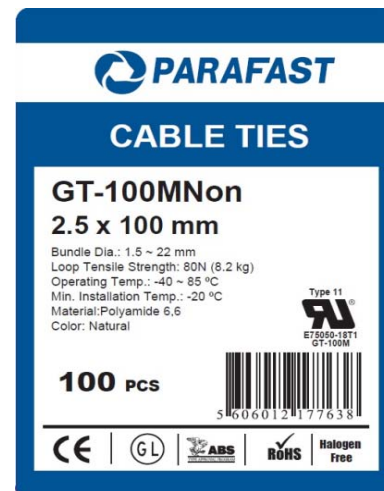

PRETO

BRANCO

VERMELHO

AMARELO

VERDE

AZUL

RAL 3000

RAL 1021

RAL 6032

RAL 5010

Dimensões em mm

TAMANHO	LARGURA	COMPRIM.	ATADO	RESISTÊNCIA DO LAÇO			PREÇO	
							CORES	PRETO/ BRANCO
			Ø máx.	[Kg] ([lbs])				
2,5x100	2,5	100	22	8.1 (18)	100	55000	1,58	0,69
2,5x140	2,5	140	33	8.1 (18)	100	45000		1,24
2,5x160	2,5	160	40	8.1 (18)	100	40000		1,33
2,5x200	2,5	200	53	8.1 (18)	100	30000		1,51
3,6x140	3,6	140	33	18.2 (40)	100	28000	2,90	1,47
3,6x200	3,6	200	53	18.2 (40)	100	20000	3,96	1,97
3,6x250	3,6	250	65	18.2 (40)	100	20000		2,61
3,6x300	3,6	300	76	18.2 (40)	100	17000		3,02
4,8x188	4,8	188	46	22.2 (50)	100	16000		2,62
4,8x200	4,8	200	50	22.2 (50)	100	15000	5,54	2,81
4,8x250	4,8	250	60	22.2 (50)	100	12000		3,77
4,8x300	4,8	300	76	22.2 (50)	100	11000	7,92	4,14
4,8x370	4,8	370	102	22.2 (50)	100	9000		5,13
7,6x250	7,6	250	60	54.4 (120)	100	6000		9,65
7,6x300	7,6	300	76	54.4 (120)	100	5000		10,48
7,6x370	7,6	370	102	54.4 (120)	100	4000		11,32
7,6x450	7,6	450	130	54.4 (120)	100	2500		16,42
7,6x540	7,6	540	140	54.4 (120)	100	2000		20,20

Edição: 1/2006

Data: Setembro 2006

Revisão: 5

Data: 6 de novembro 2023

Preço: €100

TABELA 7.016

ABRAÇADEIRAS "CINTO" EM POLIAMIDA 12



• POLIAMIDA 12 • PRETO



POLIAMIDA 12 - CARACTERÍSTICAS DA MATÉRIA PRIMA

Absorção de humidade:	≤1%
Temperatura de trabalho:	-40°C a +85°C
Temperatura de aplicação:	-20°C a +60°C
Ponto máximo admissível:	+120°C por um curto período
Temperatura de fusão:	+186°C
Índice limite de oxigénio:	22,5%
Taxa de inflamabilidade:	UL 94 classe HB
Resistência dieléctrica:	28 000 Volts/mm

Resistência ao meio ambiente:

- Elevada resistência às bases, óleos, massas, derivados do petróleo, solventes clorídricos;
- Resistente às radiações UV;
- Resinas livres de halogéneos.

Dimensões em mm

TAMANHO	CABEÇA	LARGURA	COMPRIM.	ATADO		RESISTÊNCIA À TRACÇÃO			PREÇO
				Ø mín.	Ø máx.	[Kg]	[N]		
9x180	SIMPLES	9	180	15	40	36,72	360	100	8,98
9x265	DUPLA	9	265	30	60	51	500	100	12,47
9x360	DUPLA	9	360	30	93	51	500	100	18,46

BUCHA PARA FIXAR ABRAÇADEIRAS



• NYLON

Para abraçadeiras DE FIVELA e abraçadeiras "CINTO"

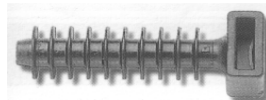
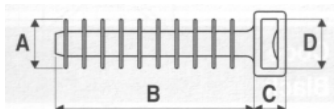

DESIGNAÇÃO	DIMENSÕES [mm]						PREÇO
	Ø FURO	A	B	C	D		
BUCHA PARA FIXAR ABRAÇADEIRAS	8	10	37	6,5	9,7	100	3,60

ESTICADORES PARA ABRAÇADEIRAS



CARACTERÍSTICAS:
 - Ferramenta em metal;
 - Dispositivo automático de corte;
 - Tensão de aperto regulável;
 - P/ abraçadeiras de 2,2 até 4,8 mm de largura.



CARACTERÍSTICAS:
 - Ferramenta profissional em metal;
 - P/ abraçadeiras de 4,8 até 9 mm de largura.

Ref.ª 5401

DESIGNAÇÃO	PREÇO/Unidade
ESTICADOR PARA ABRAÇADEIRAS DE FIVELA	35,92

Ref.ª 5400

DESIGNAÇÃO	PREÇO/Unidade
ESTICADOR PARA ABRAÇADEIRAS "CINTO"	22,45

Edição: 1/2006
Data: Setembro 2006

Revisão: 1
Data: 19 de Abril 2010

Preço: €100

TABELA 7.17

**CLIPS EM POLIETILENO (PE)
PARA CABOS REDONDOS E PLANOS
(MONTADOS COM PREGO)**



• POLIETILENO (PE)



CLIPS PARA CABOS REDONDOS

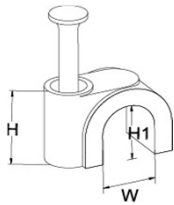

CLIPS PARA CABOS PLANOS

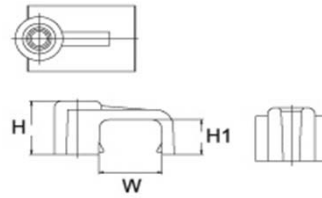

CARACTERÍSTICAS DA MATÉRIA PRIMA

CLIP:

- POLIETILENO (PE);
- Flexível - resistente a impactos sem partir;
- Cor branca.

PREGO:

- Aço;
- Montado no clip - poupa tempo e custos.

EMBALAGEM: BLISTER 100 Unidades



TIPO	CLIP	W [mm]	H [mm]	H1 [mm]	PREGO	GAMA DE CABOS	BLISTER		PREÇO
REDONDO	GC-0.4	4,0	6,6	4,2	Ø2.5 x 18	1 par de fios	100	30 000	1,73
	GC-0.5	5,0	7,6	5,3	Ø2.5 x 18	3C2V antena 5 pares de fios	100	30 000	1,77
	GC-1	6,0	9,0	6,6	Ø2.5 x 20	5C2V antena 10 pares de fios	100	25 000	2,09
	GC-1.5	7,0	11,0	7,2	Ø2.5 x 22	10 pares de fios	100	25 000	2,46
	GC-2	8,0	11,5	8,6	Ø2.5 x 22	fios 3C 1.25 m/m ²	100	18 000	2,65
	GC-2.5	9,0	12,0	9,0	Ø2.5 x 25	20 pares de fios	100	18 000	2,61
	GC-3	10,0	13,4	10,5	Ø2.5 x 27	3C 3.25 m/m ² ; 3C 2 m/m ² ; 20 pares	100	10 000	2,67
PLANO	GFC-0.75	6,0	6,2	4,1	Ø1.5 x 18	0.75 mm ²	100	20 000	2,67
	GFC-1.0	8,0	7,5	4,3	Ø2.0 x 24	1.0 mm ²	100	18 000	2,91
	GFC-1.5	9,0	7,8	5,0	Ø2.0 x 24	1.5 mm ²	100	15 000	3,46

BUCHAS PARA CAPOTO LTX-10

KLIMAS
FASTENER TECHNOLOGIES



**BUCHA DE EXPANSÃO POR IMPACTO
COM ZONA DE EXPANSÃO REDUZIDA
PARA PAINÉIS DE ISOLAMENTO EXTERIORES**



ETA-16/0509



DESIGN OTIMIZADO DA ZONA DE EXPANSÃO

Permite a instalação em todas as categorias de substratos mantendo elevados parâmetros de resistência.



DESIGN MELHORADO DA CABEÇA DO PINO

O design da cabeça do pino assegura uma boa resistência durante a instalação.



DESIGN INOVADOR DA GOLA

Uma maior rigidez da gola de suporte significa uma melhor fixação do material de isolamento térmico.



DESIGN INOVADOR DA ANILHA

Grande quantidade de cavidades para adesivo assegura uma colagem eficiente.

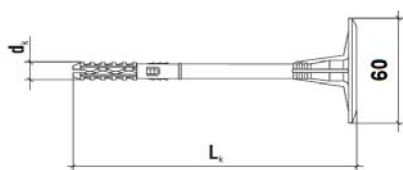
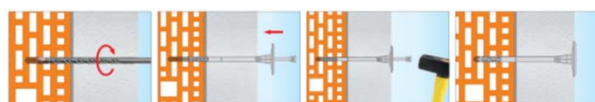

MATERIAIS BASE

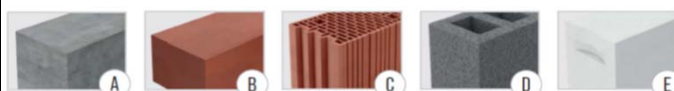

- A - Betão
- B - Tijolo maciço
- C - Tijolo oco
- D - Blocos de betão
- E - Betão aerado autoclavado

PRODUTO	TAMANHO (dk x Lk)	ESPESSURA DO MATERIAL DE ISOLAMENTO			PREÇO
		NOVAS CONSTRUÇÕES	CONSTRUÇÕES ANTIGAS		
LTX-10070	10x70	10/30	-/10	200	8,42
LTX-10090	10x90	30/50	10/30	200	9,49
LTX-10110	10x110	50/70	30/50	200	9,68
LTX-10120	10x120	60/80	40/60	200	11,78
LTX-10140	10x140	80/100	60/80	200	12,97
LTX-10160	10x160	100/120	80/100	200	14,07
LTX-10180	10x180	120/140	100/120	200	15,33
LTX-10200	10x200	140/160	120/140	200	18,65
LTX-10220	10x220	160/180	140/160	100	21,26
LTX-10260	10x260	200/220	180/200	100	24,26

ACESSÓRIOS

CORTANTE PLÁSTICO PARA POLIESTIRENO EPS

- Cortante plástico para fazer furos em material isolante de poliestireno EPS para inserção de disco de poliestireno EPS.
- Profundidade de corte controlada, colar de encosto com diâmetro de 90 mm.



PRODUTO	Ø [mm]		PREÇO €/Unidade
WK-FT	Ø 66,7	1	7,60

DISCOS DE POLIESTIRENO



Discos em Poliestireno para tapar os furos - montagens embutidas -

PRODUTO	Cor	Dimensões [mm]		PREÇO
KS	Branco	Ø 67 x 17	100	9,86
KSG	Grafite			

BUCHAS PARA LÃ DE ROCHA LMX-10

KLIMAS
FASTENER TECHNOLOGIES



**BUCHA DE EXPANSÃO POR IMPACTO
COM ZONA DE EXPANSÃO REDUZIDA
PARA PAINÉIS DE ISOLAMENTO EXTERIORES
- PINO METÁLICO - ADEQUADO PARA LÃ DE ROCHA**



ETA-16/0509



DESIGN OTIMIZADO DA ZONA DE EXPANSÃO

Permite a instalação em todas as categorias de substratos mantendo elevados parâmetros de resistência.



PINO METÁLICO COM CABEÇA EM PLÁSTICO

A transferência térmica pontual reduzida melhora o coeficiente de transferência de calor de toda a barreira e, adicionalmente, protege o perno contra a corrosão.



DESIGN INOVADOR DA GOLA

Grande quantidade de cavidades para adesivo assegura uma colagem eficiente. Uma maior rigidez da gola de suporte significa uma melhor fixação do material de



CURTA ZONA DE EXPANSÃO, 10 mm DE DIÂMETRO

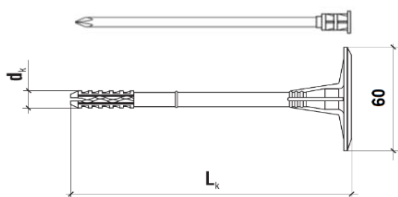
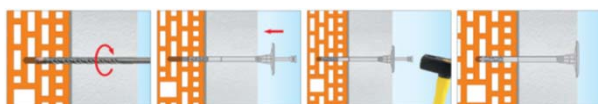

MATERIAIS BASE

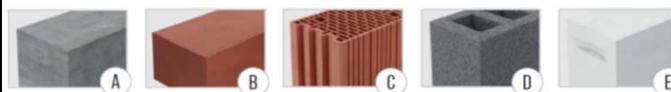

A - Betão B - Tijolo maciço C - Tijolo oco

MATERIAIS DE ISOLAMENTO

• Styrofoam EPS • Styrofoam XPS • Lã de rocha

PRODUTO	TAMANHO (dk x Lk)	ESPESSURA DO MATERIAL DE ISOLAMENTO			PREÇO
		NOVAS CONSTRUÇÕES	CONSTRUÇÕES ANTIGAS		
LMX-10070	10x70	10/30	-/10	200	26,07
LMX-10090	10x90	30/50	10/30	200	31,89
LMX-10110	10x110	50/70	30/50	200	35,66
LMX-10120	10x120	60/80	40/60	200	38,68
LMX-10140	10x140	80/100	60/80	200	44,62
LMX-10160	10x160	100/120	80/100	200	51,76
LMX-10180	10x180	120/140	100/120	200	56,65
LMX-10200	10x200	140/160	120/140	200	60,76
LMX-10220	10x220	160/180	140/160	100	70,04
LMX-10260	10x260	200/220	180/200	100	85,13

ACESSÓRIOS

CORTANTE METÁLICO PARA LÃ DE ROCHA

- Cortante metálico para fazer furos em lâ de rocha para inserção de disco de lâ de rocha.
- Profundidade de corte controlada, colar de encosto com diâmetro de 95 mm.



PRODUTO	Ø [mm]		PREÇO €/Unidade
WK-FM	Ø 66,7	1	135,49

DISCOS EM LÃ DE ROCHA



Discos em lâ de rocha para tapar os furos - montagens embutidas -

NOVO PREÇO

PRODUTO	Densidade	Dimensões [mm]		PREÇO
EDMW	130 kg/m3	Ø 67 x 17	100	65,00

• Ver tabela 7.25 para cortantes e discos de outros materiais.

BUCHAS HELICOIDAIS PARA ROSCAR NO CAPOTO WK-DS

KLIMAS
FASTENER TECHNOLOGIES

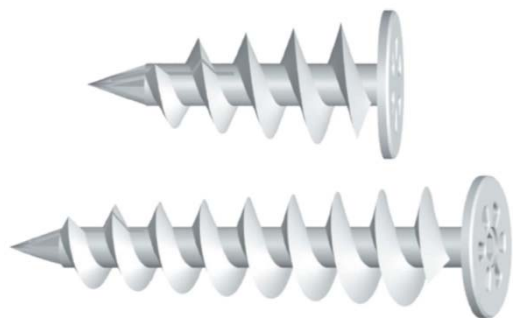

CARACTERÍSTICAS:

- Comprimento de 50 e 85 mm;
- Para fixar componentes leves (máximo 5 kg por bucha) a paredes de isolamento em poliestireno;
- Usadas com parafusos de diâmetro 4,5 mm;
- Montagem com chave TX-30.



PRODUTO	Comprimento [mm]	Ø Cabeça [mm]		PREÇO
WK-DS050	50	28	10	65,61
WK-DS085	85	28	10	105,11

ANILHAS ESPAÇADORAS / NIVELADORAS DW



KLIMAS
FASTENER TECHNOLOGIES

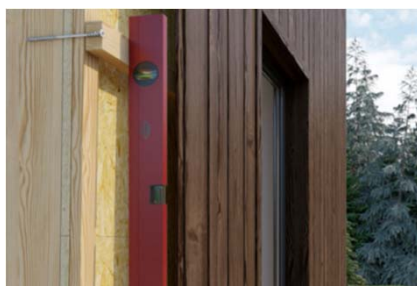

ESPECIFICAÇÕES:

- Anilhas espaçadoras e niveladoras para estruturas de painéis;
- Com código de cores para identificar a espessura.



PRODUTO	Cor	Espessura [mm]		PREÇO
DW-02		2	50	6,81
DW-03		3	50	7,12
DW-04		4	50	7,99
DW-05		5	50	9,04
DW-08		8	50	12,88
DW-10		10	50	14,84
DW-15		15	50	18,99

BUCHAS EM NYLON PARA CAIXILHARIA KPS-FAST / KPR-FAST

KLIMAS
FASTENER TECHNOLOGIES



KPS-FAST S KPS-FAST K KPR-FAST K

**BUCHA EM NYLON PARA CAIXILHARIA
PARAFUSO EM AÇO COM REVESTIMENTO EM
FLOCOS DE ZINCO**

FIXAÇÃO FIÁVEL E SEGURA

REVESTIMENTO EM FLOCOS DE ZINCO

O revestimento de flocos de zinco oferece duas vezes melhor resistência à corrosão em comparação com o zinco padrão. Excelente qualidade do revestimento comprovada através de testes em câmara de névoa salina.

RESISTÊNCIA AO FOGO

Para a montagem de sistemas de fachada, a bucha tem uma resistência ao fogo suficiente de, pelo menos, 90 minutos (R90) se a carga admissível para uma única fixação $\leq 0,8\text{kN}$ sem carga de tração centrada permanente.

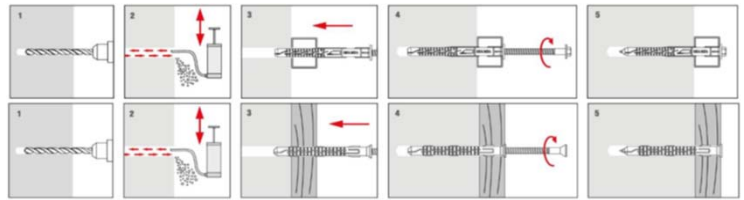

ETA-12/0272



PRODUTO	Diâmetro do furo d0	dk x Lk	dw x Lw	Chave TX/SW	Espessura do material a fixar tfix		PREÇO			
KPS-FAST-08080S KPS-FAST-08100S KPS-FAST-08120S KPS-FAST-08140S	8	8 x 80	6 X 85	TX-30	10 / 30	50	35,82			
		8 x 100	6 X 105		30 / 50	50	43,36			
		8 x 120	6 X 125		50 / 70	50	50,60			
		8 x 140	6 X 145		70 / 90	50	58,32			
KPS-FAST-10080S KPS-FAST-10100S KPS-FAST-10120S KPS-FAST-10140S KPS-FAST-10160S KPS-FAST-10180S KPS-FAST-10200S KPS-FAST-10230S KPS-FAST-10260S KPS-FAST-10300S	10	10 x 80	7 x 85	TX-40	10 / 30	50	39,98			
		10 x 100	7 x 105		30 / 50	50	45,19			
		10 x 120	7 x 125		50 / 70	50	52,69			
		10 x 140	7 x 145		70 / 90	25	59,54			
		10 x 160	7 x 165		90 / 110	25	69,40			
		10 x 180	7 x 185		110 / 130	25	91,80			
		10 x 200	7 x 205		130 / 150	25	101,44			
		10 x 230	7 x 235		160 / 180	25	121,74			
		10 x 260	7 x 265		190 / 210	25	146,10			
		10 x 300	7 x 305		230 / 250	25	175,30			
		KPS-FAST-08080K KPS-FAST-08100K KPS-FAST-08120K KPS-FAST-08140K	8		8 x 80	6 X 85	TX-30 SW-10	10 / 30	50	38,20
					8 x 100	6 X 105		30 / 50	50	47,07
8 x 120	6 X 125			50 / 70	50	56,92				
8 x 140	6 X 145			70 / 90	50	66,00				
KPR-FAST-10080K KPR-FAST-10100K KPR-FAST-10120K KPR-FAST-10140K KPR-FAST-10160K KPR-FAST-10180K KPR-FAST-10200K KPR-FAST-10230K KPR-FAST-10260K KPR-FAST-10300K	10	10 x 80	7 x 85	TX-40 SW-13	out-30	50	44,20			
		10 x 100	7 x 105		30 / 50	50	58,39			
		10 x 120	7 x 125		50 / 70	50	66,24			
		10 x 140	7 x 145		70 / 90	25	74,32			
		10 x 160	7 x 165		90 / 110	25	80,15			
		10 x 180	7 x 185		110 / 130	25	96,80			
		10 x 200	7 x 205		130 / 150	25	108,83			
		10 x 230	7 x 235		160 / 180	25	130,61			
		10 x 260	7 x 265		190 / 210	25	156,73			
		10 x 300	7 x 305		230 / 250	25	188,08			
KPR-FAST-12100K KPR-FAST-12120K KPR-FAST-12140K KPR-FAST-12160K KPR-FAST-12180K KPR-FAST-12200K KPR-FAST-12230K KPR-FAST-12260K KPR-FAST-12300K	12	12 x 100	8 x 105	TX-40 SW-13	30 / 50	25	53,50			
		12 x 120	8 x 125		50 / 70	50	66,75			
		12 x 140	8 x 145		70 / 90	25	72,71			
		12 x 160	8 x 165		90 / 110	25	84,81			
		12 x 180	8 x 185		110 / 130	25	119,64			
		12 x 200	8 x 205		130 / 150	25	135,30			
		12 x 230	8 x 235		160 / 180	25	162,36			
		12 x 260	8 x 265		190 / 210	25	194,83			
12 x 300	8 x 305	230 / 250	20	233,82						

BUCHAS EM NYLON PARA CAIXILHARIA KPS-FAST-A4 / KPR-FAST-A4

KLIMAS
FASTENER TECHNOLOGIES



KPS-FAST S-A4

KPS-FAST K-A4

KPR-FAST K-A4

BUCHA EM NYLON PARA CAIXILHARIA PARAFUSO EM AÇO INOX-A4

FIXAÇÃO FIÁVEL E SEGURA



AÇO INOXIDÁVEL A4

Máxima proteção contra a corrosão.

RESISTÊNCIA AO FOGO

Para a montagem de sistemas de fachada, a bucha tem uma resistência ao fogo suficiente de, pelo menos, 90 minutos (R90) se a carga admissível para uma única fixação $\leq 0,8\text{kN}$ sem carga de tração centrada permanente.

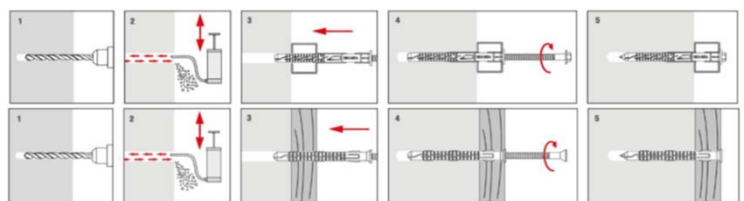

ETA-12/0272



PRODUTO	Ø furo d0	dk x Lk	dw x Lw	Chave TX/SW	Espessura do material a fixar tfix		PREÇO
KPS-FAST-08080S-A4	8	8 x 80	6 X 85	TX-30	10 / 30	50	130,30
KPS-FAST-08100S-A4		8 x 100	6 X 105		30 / 50	50	157,71
KPS-FAST-08120S-A4		8 x 120	6 X 125		50 / 70	50	184,08
KPS-FAST-08140S-A4		8 x 140	6 X 145		70 / 90	50	212,06
KPS-FAST-10080S-A4	10	10 x 80	7 x 85	TX-40	10 / 30	50	146,45
KPS-FAST-10100S-A4		10 x 100	7 x 105		30 / 50	50	165,61
KPS-FAST-10120S-A4		10 x 120	7 x 125		50 / 70	50	193,11
KPS-FAST-10140S-A4		10 x 140	7 x 145		70 / 90	25	209,83
KPS-FAST-10160S-A4		10 x 160	7 x 165		90 / 110	25	233,15
KPS-FAST-10180S-A4		10 x 180	7 x 185		110 / 130	25	307,33
KPS-FAST-10200S-A4		10 x 200	7 x 205		130 / 150	25	384,51
KPS-FAST-08080K-A4		8	8 x 80		6 X 85	TX-30 SW-10	10 / 30
KPS-FAST-08100K-A4	8 x 100		6 X 105	30 / 50	50		172,46
KPS-FAST-08120K-A4	8 x 120		6 X 125	50 / 70	50		208,78
KPS-FAST-08140K-A4	8 x 140		6 X 145	70 / 90	50		241,87
KPR-FAST-10080K-A4	10	10 x 80	7 x 85	TX-40 SW-13	10 / 30	50	162,10
KPR-FAST-10100K-A4		10 x 100	7 x 105		30 / 50	50	214,06
KPR-FAST-10120K-A4		10 x 120	7 x 125		50 / 70	50	242,92
KPR-FAST-10140K-A4		10 x 140	7 x 145		70 / 90	25	262,00
KPR-FAST-10160K-A4		10 x 160	7 x 165		90 / 110	25	282,61
KPR-FAST-10180K-A4		10 x 180	7 x 185		110 / 130	25	354,90
KPR-FAST-10200K-A4		10 x 200	7 x 205		130 / 150	25	433,36

BUCHAS LONGAS EM NYLON KPR

KLIMAS
FASTENER TECHNOLOGIES

PA
100% NYLON

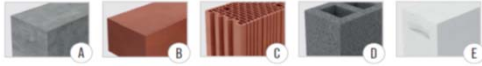

- A - Betão
- B - Tijolo maciço
- C - Tijolo oco
- D - Blocos de betão
- E - Betão aerado autoclavado

PRODUTO	Diâmetro do furo d0	dk x Lk		PREÇO
W-KPR-08065	8	8 x 65	50	11,52
W-KPR-08080		8 x 80	50	13,48
W-KPR-08100		8 x 100	50	14,88
W-KPR-08120		8 x 120	50	17,46
W-KPR-08140		8 x 140	50	19,56
W-KPR-10060	10	10 x 60	50	17,55
W-KPR-10080		10 x 80	50	18,79
W-KPR-10100		10 x 100	50	22,91
W-KPR-10120		10 x 120	50	26,54
W-KPR-10140		10 x 140	25	31,08
W-KPR-10160		10 x 160	25	34,92
W-KPR-10180		10 x 180	25	39,95
W-KPR-10200		10 x 200	25	44,84
W-KPR-10230		10 x 230	25	59,37

BUCHAS EM NYLON PARA ANDAIMES COM OLHAL ZINCADO HOX

KLIMAS
FASTENER TECHNOLOGIES

BUCHA EM NYLON COM OLHAL EM AÇO ZINCADO
- ESPECIAL PARA FIXAR ANDAIMES AOS EDIFÍCIOS -

Zn
WHITE

PA
100% NYLON

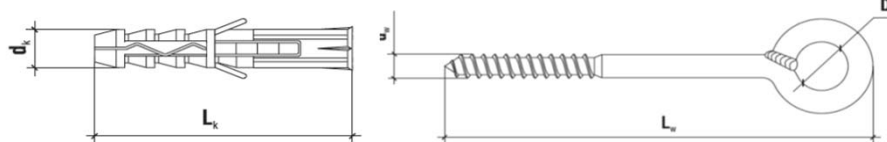
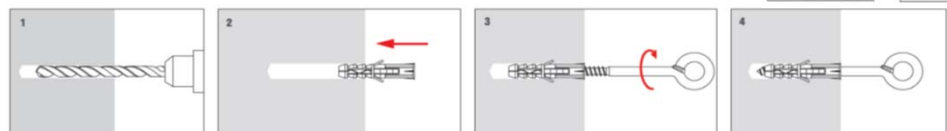

Preço:
BUCHA + OLHAL

PRODUTO	Diâmetro do furo d0	dk x Lk	dw x Lw	Ø OLHAL D0		PREÇO
HOX-14120	14	14 x 80	10 x 165	25	20	240,88
HOX-14160		14 x 80	10 x 205	25	20	265,86
HOX-14190		14 x 80	10 x 235	25	20	286,59
HOX-14230		14 x 80	10 x 275	25	20	307,36
HOX-16160	16	16 x 100	12 x 210	25	15	286,59
HOX-16190		16 x 100	12 x 240	25	15	307,36
HOX-16230		16 x 100	12 x 280	25	15	382,10
HOX-16300		16 x 100	12 x 350	25	15	481,82
HOX-16350		16 x 100	12 x 400	25	15	602,77

PARAFUSOS DE ROSCAR NO BETÃO PARA CAIXILHARIA WHO / WHOW

KLIMAS
FASTENER TECHNOLOGIES

WHO
CABEÇA CHATA



WHOW
CABEÇA CILÍNDRICA



INSTALAÇÃO RÁPIDA

Parafusos para a instalação de caixilhos de portas e janelas que facilitam a fixação e possibilitam a instalação eficiente em grandes séries.

SEM ESFORÇOS DE TRAÇÃO DURANTE A INSTALAÇÃO

Os parafusos permitem fixar os caixilhos aos suportes sem gerar esforços de tração causando a compressão dos caixilhos sobre os suportes.

TOTALMENTE ROSCADOS

Garantem a manutenção segura e fiável da fixação enquanto matêm uma distância apropriada entre o caixilho e o suporte.

ROSCA SERRILHADA

Rosca especial serrilhada que reduz a resistência de aperto durante a instalação.

CARACTERÍSTICAS

- Parafusos de roscar no betão
- Em aço zincado
- Para fixar caixilhos em PVC (WHO) e em madeira (WHOW)
- Totalmente roscados
- O design da rosca assegura fixações fiáveis e de longa duração
- Rosca serrilhada para diminuir o esforço de aperto
- Para fixar caixilhos de portas e janelas em suportes de alvenaria e madeira

Para caixilhos em **PVC**

Para caixilhos em **MADEIRA**

SUPORTES ADEQUADOS

- Betão
- Tijolo maciço
- Betão aerado autoclavado

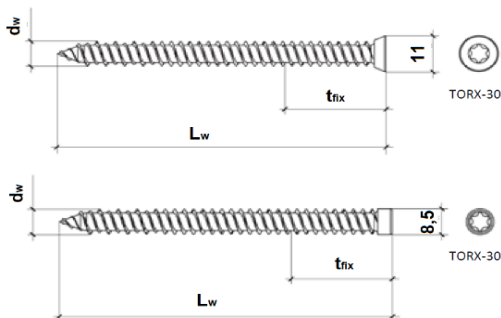

Ø parafuso (dw)	7,5 mm
Ø furo	6 mm
Profundidade de fixação	30/40/60*
Profundidade do furo	40/50/70*
Chave	TORX-30

*- betão / tijolo / betão aerado autoclavado

PRODUTO	TAMANHO (dw x Lw)		PREÇO		
			WHO	WHOW	
WHO-75042	WHO-75042	7,5 x 42	200	12,92	12,92
WHO-75062	WHO-75062	7,5 x 62	200	13,74	13,74
WHO-75082	WHO-75082	7,5 x 82	100	18,64	18,64
WHO-75102	WHO-75102	7,5 x 102	100	23,22	23,22
WHO-75112	WHO-75112	7,5 x 112	100	29,61	29,61
WHO-75132	WHO-75132	7,5 x 132	100	34,34	34,34
WHO-75152	WHO-75152	7,5 x 152	100	43,17	43,17
WHO-75182	WHO-75182	7,5 x 182	100	61,37	61,37
WHO-75212	WHO-75212	7,5 x 212	100	75,71	75,71

TAPITS CABEÇA CÓNICA SM

KLIMAS
FASTENER TECHNOLOGIES

**BUCHA DE EXPANSÃO POR IMPACTO
EM POLIETILENO COM CABEÇA CÓNICA E
PARAFUSO EM AÇO ZINCADO**



ETA-19/0156



DIÂMETRO DA CABEÇA AUMENTADO

Exerce maior pressão superficial sobre os elementos a fixar.



PARAFUSO COM CABEÇA DE EMBUTIR

A cabeça de embutir do parafuso é mais maciça e a haste sob a cabeça apresenta um espessamento significativo.



ZONA DE EXPANSÃO OTIMIZADA

Garante uma expansão ideal numa ampla variedade de materiais base.

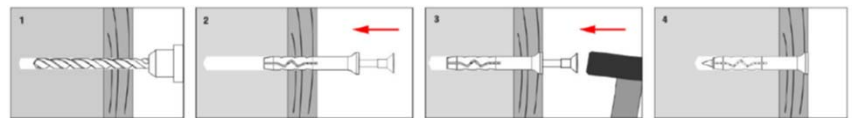
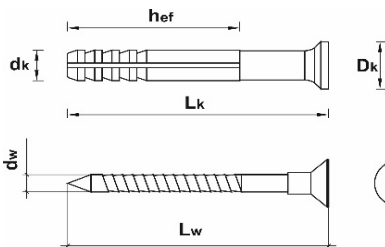

PRODUTO	dk x Lk	Diâmetro do furo d0	Diâmetro da cabeça Dk	dw x Lw	Chave PZD	Espessura do material a fixar tfix		PREÇO
SM-05025	5 x 25	5	9,5	3,5 x 30	PZ 2	0,5	200	3,47
SM-05030	5 x 30			3,5 x 35		5	200	3,72
SM-05035	5 x 35			3,5 x 40		10	200	3,97
SM-05040	5 x 40			3,5 x 45		15	200	4,15
SM-05045	5 x 45			3,5 x 50		20	200	4,37
SM-05050	5 x 50			3,5 x 55		25	200	4,48
SM-06035	6 x 35	6	10,5	3,9 x 40	PZ 2	7	200	4,28
SM-06040	6 x 40			3,9 x 45		12	200	4,26
SM-06050	6 x 50			3,9 x 55		22	200	5,89
SM-06060	6 x 60			3,9 x 65		32	200	5,98
SM-06070	6 x 70			3,9 x 75		42	200	7,73
SM-06080	6 x 80			3,9 x 85		52	100	8,54
SM-08045	8 x 45	8	11,5	4,9 x 50	PZ 2	5	100	8,21
SM-08050	8 x 50			4,9 x 55		10	100	8,72
SM-08060	8 x 60			4,9 x 65		20	100	9,72
SM-08080	8 x 80			4,9 x 85		40	100	12,71
SM-08100	8 x 100			4,9 x 105		60	100	16,42
SM-08120	8 x 120			4,9 x 125		80	100	21,60
SM-08140	8 x 140			4,9 x 145		100	100	25,10
SM-08160	8 x 160			4,9 x 165		120	100	28,17
SM-10080	10 x 80	10	14,5	6,9 x 90	PZ 3	30	50	25,03
SM-10100	10 x 100			6,9 x 110		50	50	29,53
SM-10120	10 x 120			6,9 x 130		70	50	37,04
SM-10140	10 x 140			6,9 x 150		90	50	43,36
SM-10160	10 x 160			6,9 x 170		110	50	52,03
SM-10180	10 x 180			6,9 x 190		130	50	61,22
SM-10200	10 x 200			6,9 x 210		150	50	68,37
SM-10220	10 x 220			6,9 x 230		170	50	83,15

BUCHA METÁLICA DE CUNHA "MTA" LE-ZNA4 / LE-A4

KLIMAS
FASTENER TECHNOLOGIES

BUCHA METÁLICA DE CUNHA LE-ZNA4 - ZINCADA COM ANEL INOX-A4 LE-A4 - INOX A4



ETA-20/0641



LE-ZNA4

LE-A4

BUCHA METÁLICA DE CUNHA

Para betão de resistência normal, fissurado ou não-fissurado, reforçado ou não-reforçado (C20/25 a C50/60)

PROTEÇÃO ANTICORROSÃO

- Aço galvanizado - Garante um elevado grau de proteção anticorrosiva.
- Aço Inoxidável A4 - Maior nível de proteção anticorrosiva.

RESISTENTE SOB EXPOSIÇÃO AO FOGO: R30-R120

- As características das buchas no que respeita à resistência à carga sob exposição ao fogo influenciam a segurança das fixações durante um incêndio. O valor de resistência à carga sob exposição ao fogo determinado para uma determinada duração de incêndio de R30 a R120 permite projetar fixações ideais para cada tipo de aplicação atendendo à classe de resistência ao fogo exigida.



R30 - R120



Betão fissurado e

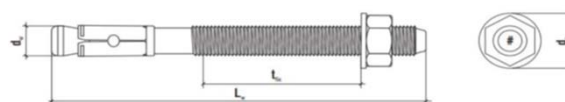
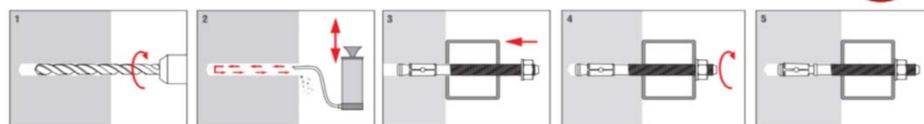

PRODUTO	Diâmetro do furo d0	Dw x Lw	BUCHA		Espessura do material a fixar tfix (máx.)		PREÇO	
			ROSCA	PORCA			LE-ZNA4	LE-A4
LE-ZNA4-08060	LE-A4-08060	8 x 60	M8	SW-13	- / 5	100	44,94	121,72
LE-ZNA4-08075	LE-A4-08075	8 x 75			- / 20	100	50,63	132,91
LE-ZNA4-08095	LE-A4-08095	8 x 95			- / 40	50	54,90	144,08
LE-ZNA4-08115	LE-A4-08115	8 x 115			- / 60	50	56,33	147,82
LE-ZNA4-08135	LE-A4-08135	8 x 135			- / 80	50	67,32	169,61
LE-ZNA4-08155	LE-A4-08155	8 x 155			- / 100	50	70,97	197,33
LE-ZNA4-10085	LE-A4-10085	10 x 85	M10	SW-17	5 / 25	50	81,40	213,64
LE-ZNA4-10095	LE-A4-10095	10 x 95			15 / 35	50	90,86	238,51
LE-ZNA4-10105	LE-A4-10105	10 x 105			25 / 45	25	97,08	254,82
LE-ZNA4-10115	LE-A4-10115	10 x 115			35 / 55	25	100,33	263,34
LE-ZNA4-10135	LE-A4-10135	10 x 135			55 / 75	25	127,23	305,12
LE-ZNA4-10155	LE-A4-10155	10 x 155			75 / 95	25	143,80	339,71
LE-ZNA4-12085	LE-A4-12085	12 x 85	M12	SW-19	- / 5	40	113,56	298,12
LE-ZNA4-12095	LE-A4-12095	12 x 95			- / 15	50	118,31	310,55
LE-ZNA4-12105	LE-A4-12105	12 x 105			5 / 25	50	125,40	329,20
LE-ZNA4-12115	LE-A4-12115	12 x 115			15 / 35	40	144,68	379,76
LE-ZNA4-12125	LE-A4-12125	12 x 125			25 / 45	25	150,96	396,24
LE-ZNA4-12145	LE-A4-12145	12 x 145			45 / 65	25	174,04	456,83
LE-ZNA4-12165	LE-A4-12165	12 x 165	65 / 85	25	214,18	505,97		
LE-ZNA4-16105	LE-A4-16105	16 x 105	M16	SW-24	- / 5	25	268,89	635,28
LE-ZNA4-16115	LE-A4-16115	16 x 115			- / 15	25	288,52	681,58
LE-ZNA4-16125	LE-A4-16125	16 x 125			5 / 25	25	310,21	732,88
LE-ZNA4-16145	LE-A4-16145	16 x 145			25 / 45	20	347,38	820,70
LE-ZNA4-16165	LE-A4-16165	16 x 165			45 / 65	15	394,33	931,65

PARAFUSOS COM CABEÇA OCULTA TORX E DUAS ROSCAS - PARA DECK HNT

KLIMAS
FASTENER TECHNOLOGIES

• INOX A2

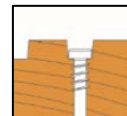

EN 14592+A1:2012

CARACTERÍSTICAS E VANTAGENS:

- Fenda TORX – garante uma ótima transferência de binário;
- Cabeça cilíndrica estreita – a largura e o formato da cabeça combinam com as tábuas do piso deck;
- Rosca sob a cabeça – garante uma instalação segura;
- Ponta autoperfurante especial – permite um início rápido da instalação do parafuso e evita que a madeira estale.

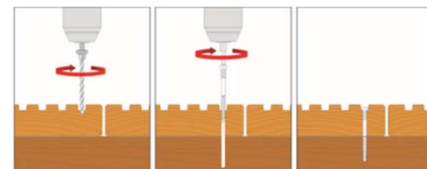
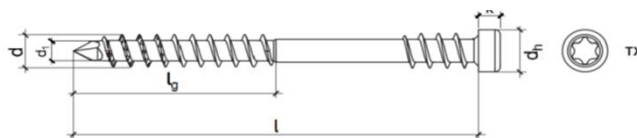

PRODUTO	d x L [mm]	Diâmetro da cabeça dh [mm]	Altura da cabeça k [mm]	Comprimento da rosca lg [mm]	Fenda TORX		PREÇO
HNT-50050-A2	5 x 50	7,35	3,2	22,5	TX-25	100	23,12
HNT-50060-A2	5 x 60	7,35	3,2	27,5	TX-25	100	27,64
HNT-50070-A2	5 x 70	7,35	3,2	32,5	TX-25	100	31,53
HNT-50080-A2	5 x 80	7,35	3,2	37,5	TX-25	100	35,58

PARAFUSOS AUTOPERFURANTES SEXTAVADOS - ZINCADOS / LACADOS WF

KLIMAS
FASTENER TECHNOLOGIES



ETA
CE
ETA-16/0443

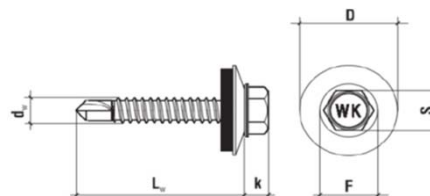
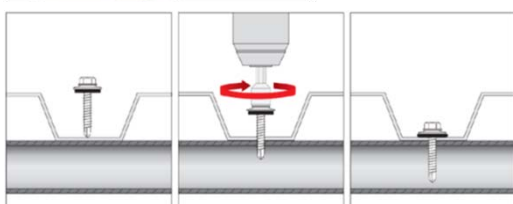

CORES RAL

3005
3009
3011
6005
6020
7016
7024
8004
8017
8019
9003
9005
9006
9010

PRODUTO	dw x Lw		Comp. Útil tfix [mm]	Chave SW		PREÇO
WF-48019-RAL	4,8 X 19	≤ 3	4	8	250	8,25
WF-48025-RAL	4,8 X 25		10		250	9,23
WF-48035-RAL	4,8 X 35		17		250	10,67
WF-55019-RAL	5,5 x 19	≤ 5	1	8	250	10,04
WF-55025-RAL	5,5 x 25		7		250	10,44
WF-55032-RAL	5,5 x 32		14		250	11,60
WF-55045-RAL	5,5 x 45		27		200	13,21
WF-55050-RAL	5,5 x 50		32		200	14,02
WF-63019-RAL	6,3 x 19	≤ 7	1	10	200	16,77
WF-63025-RAL	6,3 x 25		7		200	18,81
WF-63032-RAL	6,3 x 32		14		200	21,46
WF-63038-RAL	6,3 x 38		20		200	26,12

PARAFUSOS PARA ROSCAR NO BETÃO WDBLS / WDBLP

KLIMAS
FASTENER TECHNOLOGIES

WDBLS



WDBLP



PARAFUSOS PARA ROSCAR NO BETÃO

WDBLS - CABEÇA SEXTAVADA

WDBLP - CABEÇA CÔNICA TORX



ETA-20/0768

ETA-20/0769



R30 - R120

INSTALAÇÃO SIMPLES E RÁPIDA

- Instalação aparafusando num furo pré feito no betão;
- A rosca especial do parafuso para betão abre uma rosca interna no betão à medida que se vai aparafusando;
- Capacidade de ser submetido a carga imediatamente.

REUTILIZÁVEL

- Possibilidade de ser reutilizado em instalações temporárias.

BAIXAS TENSÕES DE EXPANSÃO

- Os parafusos para betão geram muito menos esforços de expansão durante a instalação e a carga é distribuída ao longo de uma maior área ao longo do comprimento do parafuso. Esta característica permite ainda menores distâncias entre fixações e menores distâncias aos bordos.



Betão fissurado e não fissurado

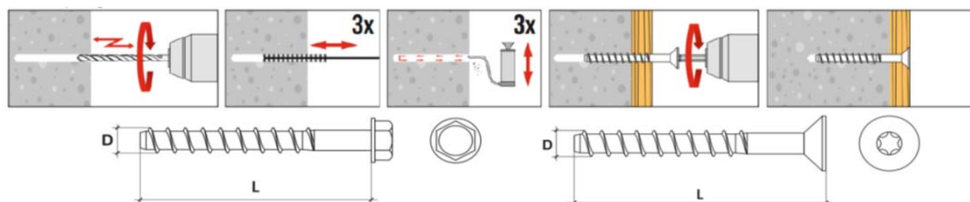

PRODUTO	Diâmetro do furo d0	D x L	Chave		Espessura do material a fixar tfix (máx.)		PREÇO		
			SW	TX			WDBLS (SW)	WDBLP (TX)	
WDBLS-06040	6	7,5 x 40	SW10	TX40	1	100	68,16		
WDBLS-06060		WDBLP-06060			7,5 x 60	5	100	82,03	89,34
WDBLS-06080		WDBLP-06080			7,5 x 80	25	100	99,94	115,69
WDBLS-06100		WDBLP-06100			7,5 x 100	45	100	122,05	131,81
		WDBLP-06120			7,5 x 120	65	100		157,14
WDBLS-08050	8	9,9 x 50	SW13	TX45	1	50	95,88		
WDBLS-08060		9,9 x 60			1	50	106,05		
WDBLS-08070		9,9 x 70			5	50	125,84		
WDBLS-08080		WDBLP-08080			9,9 x 80	15	50	140,87	189,33
WDBLS-08100		WDBLP-08100			9,9 x 100	35	50	165,71	235,52
WDBLS-08130		WDBLP-08130			9,9 x 130	65	50	217,46	293,25
WDBLS-08150		WDBLP-08150			9,9 x 150	85	50	285,12	341,07
WDBLS-10060	10	12,5 x 60	SW17	TX50	1	50	189,74		
WDBLS-10070		12,5 x 70			1	50	196,66		
WDBLS-10080		12,5 x 80			5	50	216,04		
WDBLS-10090		12,5 x 90			15	50	241,85		
WDBLS-10100		12,5 x 100			25	50	262,53		
WDBLS-10110		12,5 x 110			35	50	274,11		
WDBLS-10120		12,5 x 120			45	50	298,67		
WDBLS-10130		12,5 x 130			55 / 65	50	330,65		
WDBLS-10140		12,5 x 140			65	50	352,01		

PARAFUSOS PARA PAINÉIS SANDWICH DE ROSCAR NO BETÃO / MADEIRA WB6P

KLIMAS
FASTENER TECHNOLOGIES



PARAFUSOS AUTO-ROSCANTES COM ANILHA ALUMÍNIO / EPDM PARA FIXAR PAINÉIS SANDWICH EM BETÃO OU MADEIRA



CARACTERÍSTICAS:

- Aço ao carbono tratado termicamente;
- Revestimento cerâmico de Super Qualidade (SQ CERAMIC);
- Cabeça sextavada;
- Ponta auto-roscante;
- Anilha em alumínio com borracha EPDM.

APLICAÇÕES:

- Fixação de painéis Sandwich em suportes de betão ou madeira;
- Fixação de painéis Sandwich em coberturas;
- Fixação de painéis Sandwich em fachadas;
- Aplicações visíveis ou ocultas.



ETA-16/0444



Revestimento **SQ CERAMIC**

Revestimento laminar multicamadas de Alumínio / Zinco resistente aos danos, permite o uso em ambientes de maior corrosividade.

10 x melhor resistência anticorrosiva (em comparação com a zincagem de 5 µm).

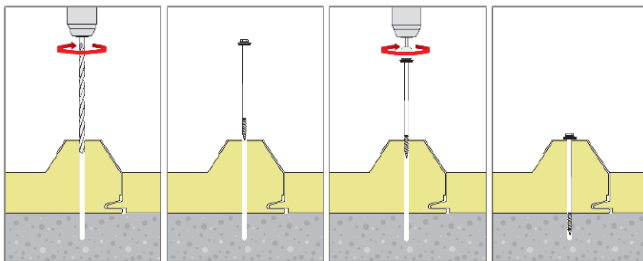

Montagens em betão

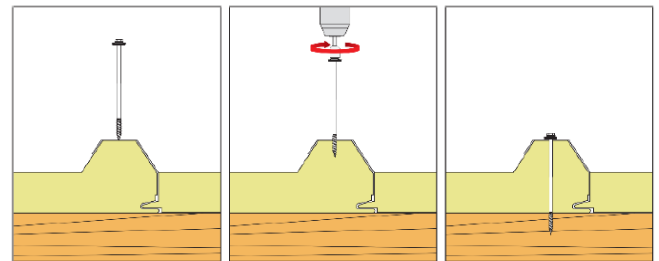

Montagens em madeira

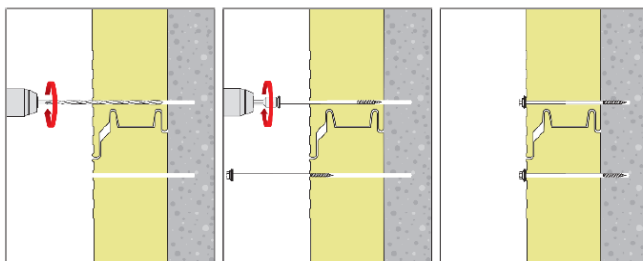

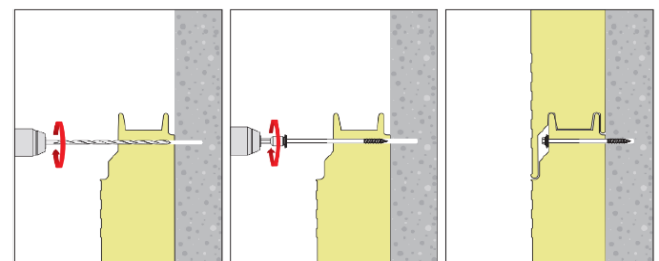

Juntas visíveis

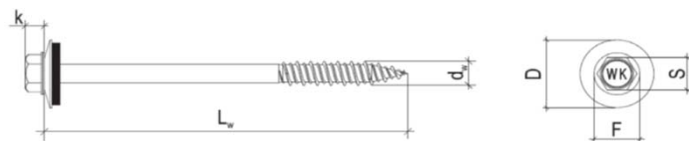

Juntas ocultas



PRODUTO	dw x Lw		Espessura do painel [mm]	Chave SW	Ø Furo (betão) [mm]	PREÇO	
							WB6P
WB6P-63045	6,3 X 45	19	0 - 40	8	5,0	100	28,79
WB6P-63085	6,3 X 85		40 - 50			100	30,69
WB6P-63095	6,3 X 95		50 - 60			100	33,99
WB6P-63115	6,3 X 115		70 - 80			100	38,49
WB6P-63135	6,3 X 135		90 - 100			100	43,26
WB6P-63155	6,3 X 155		110 - 120			100	48,93
WB6P-63185	6,3 X 185		140 - 150			100	58,74
WB6P-63205	6,3 X 205		150 - 170			100	70,50
WB6P-63235	6,3 X 235		180 - 200			100	84,59
WB6P-63255	6,3 X 255		200 - 220			100	101,50

BUCHA QUÍMICA
WORLDFIX - 400

WORLDFIX

WORLDFIX400

RESINA DE POLIÉSTER
BAIXO TEOR DE ESTIRENO
ELEVADO DESEMPENHO
ALTA QUALIDADE

M24 - Betão - Hormigón
**11.500
KG**



ETA CE

CE 1404

WORLDFIX400

Factory Plant 1
DoP: WFX400

ETA 23/0431
EAD 330076-00-0604
ETAG 029
Use Category c, w/d M8,10,12
1404-CPR-3646

ÉMISSIONS DANS L'AIR INTÉRIEUR

A+

A+ A B C

- Cargas médias;
- Aplicações em todos os tipos de materiais de construção (tijolo, pedra, betão não fissurado...);
- Válido para aplicações em lugares molhados.



ACESSÓRIOS			PREÇO
Pistola RESINA 380/400 ml			20,00
Pistola ultraleve RESINA 380/400 ml			31,00
BOQUILHA (Extra)	5	100	0,35
CAMISA 12x80	10	200	0,15
CAMISA 15x85	10	200	0,15
CAMISA 20x85	10	200	0,23

PRODUTO	VOLUME		PREÇO
WORLDFIX 400	300 ml	12	5,60
	410 ml	12	7,50

Edição: 1/2006
Data: Setembro 2006

Revisão: 13
Data: 22 de abril 2024

Preço: €/Unidade

TABELA 8.01

BUCHA QUÍMICA
WORLDFIX 500

WORLDFIX

WORLDFIX500

RESINA DE VINILÉSTER - EPOXIACRILATO
SEM ESTIRENO
ELEVADO DESEMPENHO
ALTA QUALIDADE

M24 - Betão - Hormigón
**12.000
KG**



CE 1404		CE 1404	
WORLDFIX500		WORLDFIX500	
Factory Plant 1 DoP: WFX500		Factory Plant 1 DoP: WFX500	
ETA 23/0429 EAD 330499-01-0601 M8 - M24 • 8mm - 24mm Option 7 Uncracked 1404-CPR-3644		ETA 23/0430 EAD 330076-00-0604 M6 - M12 Masonry 1404-CPR-3645	



- Cargas médias e elevadas;
- Aplicações em tijolo, madeira, pedra e betão não fissurado;
- Válido para aplicações em lugares inundados.

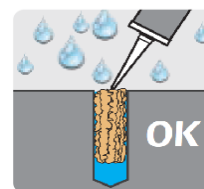

ACESSÓRIOS			PREÇO
Pistola RESINA 380/400 ml			20,00
Pistola ultraleve RESINA 380/400 ml			31,00
BOQUILHA (Extra)	5	100	0,35
CAMISA 12x80	10	200	0,15
CAMISA 15x85	10	200	0,15
CAMISA 20x85	10	200	0,23

PRODUTO	VOLUME		PREÇO
WORLDFIX 500	300 ml	12	8,00
	410 ml	12	10,00

ACESSÓRIOS PARA BUCHA QUÍMICA



PRODUTO		CARACTERÍSTICAS			PREÇO
 Ref. ^a C1330 B	PISTOLA PARA SILICONE 280/300 ml	• Qualidade profissional; • Para cartuchos de silicone de 310 ml; • Taxa de impulso 18:1; • Força de impulso > 3000 N • Placa de impulso em aço sinterizado; • Corpo rotativo; • Corpo, gatilho e punho em metal.	1		1 500,00
 Ref. ^a C1360	PISTOLA PARA RESINA 380/400ml	• Qualidade profissional; • Para cartuchos de 400 ml - coaxiais de 2 componentes; • Taxa de impulso 25:1; • Força de impulso > 3000 N; • Corpo, gatilho e punho em metal.	1		2 000,00
 Ref. ^a C1560	PISTOLA ULTRALEVE PARA RESINA 380/400ml	• Qualidade profissional; • Para cartuchos de 400 ml - coaxiais de 2 componentes; • Taxa de impulso 25:1; • Força de impulso > 4000 N; • Corpo, gatilho e punho em metal.	1		3 100,00
	BOQUILHA		10	100	35,00
	CAMISA	MEDIDA: Ø 12 x 80 mm	10	200	15,00
		MEDIDA: Ø 15 x 85 mm	10	200	15,00
		MEDIDA: Ø 20 x 85 mm	10	200	23,00

PERNOS PARA BUCHAS QUÍMICAS (com porca e anilha)



- **AÇO 5.8, 8.8, ZINCADO**
- **AÇO INOX-A2 E INOX-A4**

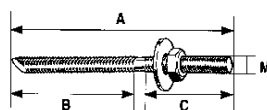

Dimensões em mm

MEDIDA	COMPRIMENTO TOTAL (A)	ROSCA ÚTIL (C)	DIÂMETRO DO FURO	PROFUNDIDADE DO FURO (B)	INOX-A4	INOX-A2	AÇO 8.8 ZINCADO	AÇO 5.8 ZINCADO
M-8 x 110	100	20	10	80	77,82	73,00	72,00	55,00
M-10 x 115	115	25	12	90			85,00	65,00
M-10 x 130	130	40	12	90	168,60	136,00	91,00	70,00
M-12 x 160	160	50	14	110	259,38	228,00	137,00	105,00
M-16 x 190	190	65	18	125	486,33	442,00	286,00	220,00
M-20 x 260	260	90	25	170	972,66	960,00	637,00	490,00
M-24 x 300	300	90	28	210	1 621,09	1 580,00	1 170,00	900,00
M-30 x 380	380	100	35	280	3 242,19	3 100,00	2 600,00	2 000,00

ESPUMA DE POLIURETANO



ESPUMA DE POLIURETANO EXPANSIVA



Manual



Para pistola

CARACTERÍSTICAS:

- Espuma de poliuretano monocomponente, auto-expansível de aplicação manual ou com pistola;
- Forte aderência a todas as superfícies;
- Excelente compacticidade;
- Bom isolamento térmico e acústico.
- Polimerização pela humidade do ar;
- Não escorre.

APLICAÇÕES:

- Preenchimento de cavidades e fendas;
- Fixação de aros;
- Enchimento de espaços vazios entre tubagens e a superfície atravessada;
- Não deve ser aplicado na montagem de aros de portas corta-fogo (para estes existe espuma corta-fogo).

Designação	Cores	Volume		PREÇO / Unidade
Espuma de poliuretano - manual	Bege	750 ml	12	5,35
Espuma de poliuretano - para pistola	Bege	750 ml	12	5,60

ESPUMA PARA TELHAS



Manual



Para pistola

DESCRIÇÃO

Soudal **Espuma para Telhas** é uma espuma adesivo para a fixação de telhas, pronta a utilizar, para aplicação manual. Possui qualidades mecânicas superiores a qualquer outro sistema para a fixação de telhas, como parafusos, pregos ou cimento. Os gases propulsores são completamente inofensivos para a camada de ozono.

Coors: cinza e terracota.

CARACTERÍSTICAS

- Fixação ultra-rápida de telhas;
- Substitui parafusos. Melhora o custo em comparação com o sistema tradicional;
- Colagem perfeita de telhas a todos os suportes, como betão, azulejos, metal, madeira, chapas de isolamento, PVC (exceto PE e PP);
- Boa resistência ao envelhecimento;
- Peso ligeiro;
- Resiste às ações do vento;
- Resistência ao gelo e ao calor;
- Secagem rápida, inclusive na presença de humidade.

APLICAÇÕES

- Instalação e reparação de telhas de lintel;
- Instalação e assentamento das telhas da parede lateral;
- Selagem de telhados ondulados.

Designação	Coors	Volume		PREÇO / Unidade
ESPUMA PARA TELHAS - MANUAL	Cinza	750 ml	12	8,20
	Terracota			
ESPUMA PARA TELHAS - PARA PISTOLA	Cinza	750 ml	12	8,50
	Terracota			

ESPUMA DE POLIURETANO CORTA-FOGO

SOUDAL

SOUDAFOAM FR



MANUAL



PARA PISTOLA

DESCRIÇÃO

Soudafoam FR é uma espuma de poliuretano pronta a usar, mono componente e auto expansiva. **Soudafoam FR** é uma espuma de poliuretano com características retardantes ao fogo, de acordo com a norma Europeia EN 1366-4. Com classificação ao fogo até 240 minutos. Certificados internacionais de teste de vários países para várias configurações. De cor vermelha para identificar o desempenho como retardante do fogo. Disponível em latas de aerossol de 750mL.
Cor: vermelho.

CARATERÍSTICAS

- Resistente ao fogo numa junta (EN 1366- 4).
- Excelente adesão às mais diversas superfícies (exceto Teflon, PE e PP).
- Alto isolamento térmico e acústico.
- Muito boa capacidade de preenchimento e fixação.
- Excelente estabilidade.
- Alta compacidade.
- Cura rápida.
- Resistência ao fogo de forma indireta por até 240 min.
- Não propaga a chama.
- Resistente ao fogo.
- Ótimo desempenho acústico.
- Bom isolamento.

APLICAÇÕES

- Enchimento resistente ao fogo em juntas de construção e montagem de aros de portas corta-fogo.

Designação	Volume		PREÇO / Unidade
Espuma de poliuretano corta-fogo SOUDAFOAM FR - MANUAL	750 ml	12	19,50
Espuma de poliuretano corta-fogo SOUDAFOAM FR - PISTOLA	750 ml	12	20,00

ESPUMA PARA CAPOTO

- SOUDABOND EASY -
PARA PISTOLA UNIVERSAL

SOUDAL

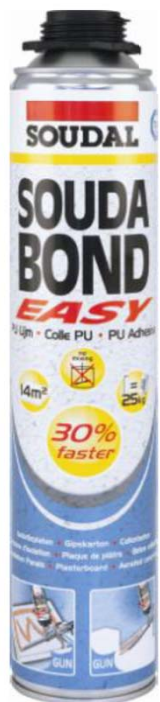

ESPUMA DE POLIURETANO PARA CAPOTO

MÉTODO SOUDABOND EASY:

- APLICAR O ADESIVO;
- UNIR APÓS 5 MINUTOS;
- PRESSIONAR FIRMEMENTE DURANTE 1 MINUTO;
- NÃO SOBRECARRREGAR DURANTE 60 MINUTOS;
- CONCLUSÃO EM APENAS 1 HORA.

- Pronto a usar e poupa tempo

- Aplicável sobre todos os materiais de construção



1 EMBALAGEM DE 750 ml ≈
14 m2 DE PLACAS DE CAPOTO



1 EMBALAGEM DE 750 ml ≈ 1 SACO DE 25 kg DE MASSA DE AGARRE



Designação	Cores	Volume		PREÇO / Unidade
Espuma para CAPOTO - SOUDABOND EASY (Pistola universal)	Laranja	750 ml	12	15,00

ACESSÓRIOS PARA ESPUMA DE POLIURETANO

SOUDAL

PRODUTO DE LIMPEZA P/ POLIURETANO



CARACTERÍSTICAS:

- Fácil;
- Rápido;
- Eficaz;
- Grande poder de limpeza.

APLICAÇÕES:

- **Limpeza de superfícies:** permite retirar imediatamente qualquer resto de espuma não endurecida;
- **Limpeza de pistolas:** especialmente concebido para a limpeza rápida, interior e exterior, das pistolas (uma limpeza regular assegura um funcionamento óptimo e previne o bloqueamento prematuro da pistola).
- **Limpeza das embalagens:** limpeza das válvulas e das ponteiros em aplicações manuais (para uma boa reutilização do produto).

PISTOLAS APLICADORAS PARA ESPUMA DE POLIURETANO



DESIGN

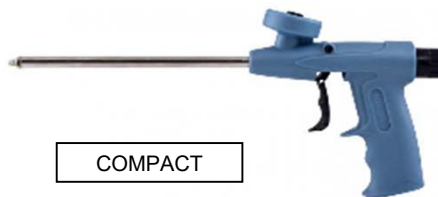

COMPACT

Designação	Volume		PREÇO / Unidade
Produto de limpeza para poliuretano	500 ml	12	8,50
Pistola aplicadora para espuma de poliuretano	"DESIGN"	1	55,00
Pistola aplicadora para espuma de poliuretano	"COMPACT"	1	30,00

SILICONE ACÉTICO "SILIRUB AS"

SOUDAL



DESCRIÇÃO:

Silirub AS é um selante de alta qualidade, elástico, mono componente, à base de silicões.

CARACTERÍSTICAS:



- Muito fácil de aplicar;
- Resistente aos raios UV;
- Impenetrável ao bolor;
- Permanentemente elástico após a cura;
- Muito boa adesão sobre muitos materiais;
- Odor acético típico.

APLICAÇÕES:

- Todos os trabalhos de vidro e de juntas;
- Juntas em casas de banho e cozinhas;
- Selagem em frigoríficos e construção de contentores;
- Selagem em sistemas de ar condicionado.

Construção Sanitário

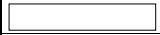
Cartucho 300 ml

VERDE		
		
≈ RAL 6005		
BRANCO		TRANSPARENTE
		
≈ RAL 9010		
	PREÇO /Un.:	3,30
24		

SILICONE ACÉTICO "UNIVERSAL"

SOUDAL



DESCRIÇÃO:

Silicone de cura acética, elástico, adequado para aplicações universal e sanitários.

CARACTERÍSTICAS:







- Muito fácil de aplicar;
- Cor permanente e resistente aos raios UV;
- Permanentemente elástico após cura
- Muito boa aderência em vários materiais;
- Baixo módulo;
- Não corrói.

APLICAÇÕES:

- Ideal para juntas sobre diversas superfícies, tanto porosas como não porosas, entre outros cerâmica, madeira pintada, vidro, porcelana;
- Juntas de expansão entre diferentes materiais de construção.

Construção

Cartucho 280 ml

CINZA			BRONZE			CASTANHO		
								
≈ RAL 7042			≈ RAL 8019			≈ RAL 8028		
PRETO			ALUMÍNIO					
								
≈ RAL 9005			≈ RAL 9006					
	PREÇO / Unidade:						4,50	
12								

SILICONE NEUTRO "SILIRUB N"

Silicone Neutro

Adequado para Alumínio lacado

SOUDAL



DESCRIÇÃO:

Selante de silicone de aplicação neutra tipo oxima de primeira qualidade para arquitectura, carpintaria e construção.

CARACTERÍSTICAS:

- Não descolora; • Excelente resistência aos raios U.V. • Inodora;
- Polimerização rápida; • Elasticidade permanente;
- Excepcional aderência sobre betão, vidro, alumínio, metal e madeira; • Fácil alisamento; • Boa extrudabilidade.

APLICAÇÕES:

- Colagem de juntas de dilatação na generalidade dos materiais de construção; • Colagem de juntas de edificação ou fachadas (menos as de vitrificação).

Embalagem:
Cartucho 300 ml

"SILIRUB N" TRANSPARENTE / BRANCO			
TRANSPARENTE	BRANCO		
	≈ RAL 9010		
	24	PREÇO / Un.:	4,10

"SILIRUB N" - CORES

VERDE GARRAFA	CINZA CLARO	CINZA	CASTANHO	BRONZE	PRETO	ALUMÍNIO
≈ RAL 6005	≈ RAL 7035	≈ RAL 7037	≈ RAL 8014	≈ RAL 8019	≈ RAL 9005	≈ RAL 9007
				24	PREÇO / Unidade:	7,40

SILICONE NEUTRO "SILIRUB NS" - COM FUNGICIDA

Silicone Neutro

Sanitário

SOUDAL



DESCRIÇÃO:

Silirub NS é um selante de alta qualidade, elástico, mono componente, à base de silicões.

CARACTERÍSTICAS:

- Muito fácil de aplicar; • Permanentemente elástico após a cura;
- Impenetrável ao bolor, contém biocida com ação fungicida; • Muito boa adesão sobre muitos materiais; • Resistente aos raios UV; • Boa resistência à humidade; • Muito boa resistência ao envelhecimento;
- MEKO livre.

APLICAÇÕES:

- Juntas em instalações sanitárias (banheiras e polibás sintéticos) e em cozinhas; • Todas as juntas de construção usuais com grande movimento;
- Juntas de expansão entre materiais de construção muito diferentes.

Embalagem:
Cartucho 300 ml

"SILIRUB NS" - COM FUNGICIDA TRANSPARENTE / BRANCO	
TRANSPARENTE	BRANCO
	≈ RAL 9010
	24
PREÇO / Un.:	5,00

SILICONE NEUTRO "SILIRUB COLOR"

Silicone Neutro

Cores RAL

SOUDAL



DESCRIÇÃO:

Selante de silicone de cura neutra em cores RAL

Silicone de cura neutra, especialmente desenvolvido para corresponder às cores RAL de todas as superfícies. Não adequado para pedra natural porosa ou aplicações sanitárias. Acabamento brilhante. De acordo com ISO 11600 F25LM e G25LM. Mais de 30 cores RAL sempre disponíveis - mais de 100 cores RAL por encomenda. Disponível em cartuchos de 300mL.

CARACTERÍSTICAS:

- Disponível em todas as cores do sistema RAL clássico; • Muito fácil de aplicar; • Cor permanente e resistente aos raios UV;
- Permanentemente elástico após cura; • Muito boa aderência em vários materiais; • Baixo módulo; • Não corrói.

APLICAÇÕES:

- Todas as juntas de edifícios com elevado movimento; • Selante premium em caixilharia de alumínio, PVC e madeira; • Juntas de expansão entre diferentes materiais de construção; • Selagem entre PVC, madeira tratada e perfis de metal com vidro.

"SILIRUB COLOR" - CORES

BEGE	BORDEAUX	VERM. TRAFFICO	AZUL GENTIL	VERDE ESCURO
RAL 1015	RAL 3005	RAL 3020	RAL 5010	RAL 6009
CINZA ESCURO	CINZA ANTRACITE	BRANCO SUJO	ALU. METALIZADO	
RAL 7011	RAL 7016	RAL 9001	RAL 9006	
				15
			PREÇO / Unidade:	8,00

Embalagem:
Cartucho 300 ml

COLA E VEDA "SOUDAFLEX 40 FC" - CARTUCHO



SOUDAL



DESCRIÇÃO:

Massa de poliuretano de primeira qualidade para a indústria.

CARACTERÍSTICAS:

- Forte colagem inicial e grande poder de adesão;
- Fixação elástica;
- À prova de choques e vibrações;
- Pintável.

APLICAÇÕES:

- Colagem de juntas em solos;
- Selador adesivo para a fixação elástica de tabiques, painéis e portas com calhas;
- Colagens e uniões em automóveis, contentores, caravanas, embarcações e peças metálicas;
- Colagem de juntas expostas a agentes químicos em solos permeáveis.

Indústria e construção

Embalagem:

Cartucho em Alumínio 300 ml

- Branco
- Preto
- Cinza
- Castanho
- Terracota



12

PREÇO / Un.:

4,70

COLA E VEDA "SOUDAFLEX 40 FC" - SALSICHÃO



SOUDAL

SOUDAFLEX 40 FC - SALSICHÃO



DESCRIÇÃO:

Massa de poliuretano de primeira qualidade para a indústria.

CARACTERÍSTICAS:

- Forte colagem inicial e grande poder de adesão;
- Fixação elástica;
- À prova de choques e vibrações;
- Pintável.

APLICAÇÕES:

- Colagem de juntas em solos;
- Selador adesivo para a fixação elástica de tabiques, painéis e portas com calhas;
- Colagens e uniões em automóveis, contentores, caravanas, embarcações e peças metálicas;
- Colagem de juntas expostas a agentes químicos em solos permeáveis.

Indústria e construção

Embalagem:

Salsichão 600 ml

- Branco
- Preto
- Cinza
- Castanho
- Terracota



PISTOLA APLICADORA PARA BOLSAS DE 600 ml

DESCRIÇÃO:

- Pistola fechada manual para bolsas de 600 ml.
- Cada pistola inclui:
 - 1 tubo em acrílico transparente
 - + 1 tubo em alumínio.



Designação	Volume		PREÇO / Unidade
COLA E VEDA SOUDAFLEX 40 FC - SALSICHÃO	600 ml	12	7,20
PISTOLA APLICADORA para bolsas de 600 ml		1	50,00

PREGO LÍQUIDO "MONTAGEPRO 140"

SOUDAL

DESCRIÇÃO:

Cola de montagem universal sem solventes.

Prego líquido

CARATERÍSTICAS:

- Aderência inicial de 140 Kg/m² com aderência imediata sem suportes;
- Compensa as desigualdades;
- Inodoro;
- Ecológico, isento de dissolventes;
- Não pinga.

140 Kg/m²

APLICAÇÕES:

• Colagens em muros de materiais muito pesados; • Encolado de poliestireno, colagens no sector da construção; • Colagens de poliestireno; • Aplicação bem firme de materiais fortes ou pesados como, por exemplo, madeira, plástico, metal, pedra, azulejos sobre superfícies de betão, pedra, tijoleira, madeiras ou aglomerado (flutuantes).

Designação	Cor	Volume		PREÇO / Unidade
MONTAGEPRO 140	Branco	310 ml	12	5,10

PREGO LÍQUIDO TRANSPARENTE "PUROCOL"

SOUDAL

DESCRIÇÃO:

Cola de montagem transparente à **base de poliuretano** com excelente resistência à água.

Hidrófuga D4

CARATERÍSTICAS:

- Hidrófugo: resistência à água D4 (DIN EN 204);
- Qualidade profissional;
- Transparente: permite uma colagem invisível;
- Não mancha;
- O seu poder de expansão assegura o preenchimento de cavidades permitindo uma melhor aderência.

Prego líquido transparente

APLICAÇÕES:

- Indicado para inúmeros materiais de construção, inclusive poliestireno expandido (esferovite);
- Aconselhado para madeiras com humidade (até 30%)

Designação	Cor	Volume		PREÇO / Unidade
PUROCOL	Transparente	310 ml	15	12,00

COLA DE MONTAGEM
FIXA MAIS
 "PROFISSIONAL" - BASE SOLVENTE

SOUDAL



DEMOS UMA MARTELADA NO PREÇO!

SOUDAL
FIXA MAIS
FIXA

ADHESIVO DE MONTAJE
 COLA DE MONTAGEN

CON/COM FIBRAS

PROFISSIONAL

base solvente

1+1 OFERTA

SEM PREGOS!
 COLA DE MONTAJE
 base solvente

1+1 OFERTA

CARATERÍSTICAS:

- Aplicação direta sobre um dos substratos com uma pistola de aplicação;
- Excelente agarre inicial;
- Colagem poderosa muito rápida;
- Colagem em superfícies irregulares, com capacidade de preenchimento de falhas;
- Torna redundante a utilização de pregos e de parafusos;
- Resistente à água.

Prego líquido

125
 Kg/m²
 AGARRE INICIAL

REFORÇADO COM FIBRAS

INTERIOR & EXTERIOR

SECAGEM RÁPIDA



2X Cartucho 405 g		COR: BEGE	
6x2	PREÇO / Unidade:	7,48	

COLA DE MONTAGEM
FIXA MAIS
 "MATERIAIS PESADOS" - BASE AQUOSA

SOUDAL



DEMOS UMA MARTELADA NO PREÇO!

SOUDAL
FIXA MAIS
FIXA

ADHESIVO DE MONTAJE
 COLA DE MONTAGEN

CON/COM FIBRAS

MATERIAIS MATERIAIS PESADOS

Agarre inicial: 250 kg/m²

80% RECICLADO

1+1 OFERTA

80% RECICLADO

1+1 OFERTA

FIJA SIN CLAVOS
 FIXAR SEM PREGOS

MATERIAIS MATERIAIS PESADOS

CARATERÍSTICAS:

- 82% Material Reciclado;
- Contém matérias-primas de origem biológica;
- Adesão inicial: 250 kg/m² (colagem da superfície total).
- Adequada para a colagem em superfícies irregulares;
- Aplicação direta sobre um dos substratos;
- Muito boa adesão sobre muitos materiais porosos;
- Adequado para o uso interior.

Prego líquido

250
 Kg/m²
 AGARRE INICIAL

REFORÇADO COM FIBRAS

80% RECICLADO

APLICAÇÕES QUARTO
 Peças decorativas
 Cabideis
 Quadros

APLICAÇÕES SALA DE ESTAR
 Pequenas prateleiras
 Quadros
 Sanças

APLICAÇÕES COZINHA
 Barra de utensílios
 Suporte especiais
 Garrafeira

2X Cartucho 350 g		COR: BRANCO	
6x2	PREÇO / Unidade:	7,48	

**COLA E VEDA
MULTIBOND - MS35**

SOUDAL

**COLA E VEDA
MULTIBOND - MS35**

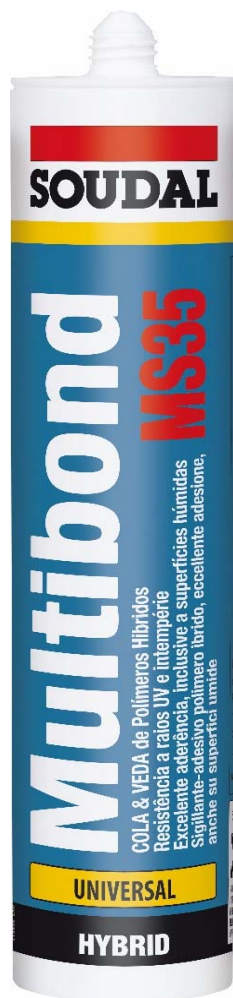

CRISTAL



CORES

Indústria e construção

DESCRIÇÃO:

Multibond MS 35 é um selante adesivo de alta qualidade, neutro, elástico, mono componente, à base de polímero SMX.

CARACTERÍSTICAS:

- Boa extrudabilidade
- Permanece elástico após a sua cura e é muito sustentável
- Impenetrável ao bolor, contém ZnP (biocida com ação fungicida)
- Excelente aderência em quase todas as superfícies, mesmo ligeiramente húmidas.
- Pode ser pintado com sistemas de base aquosa
- Inodoro.
- Não contém solventes, isocianatos, ácidos, halogéneos, nem componentes tóxicos, totalmente neutro.
- Boa estabilidade de cor, resistência UV e condições atmosféricas.

APLICAÇÕES:

- Colagem e selagem em edifícios e na construção industrial.
- Colagem fortemente elástica em construções sujeitas a vibração.
- Colagem e selagem em edifícios e na construção industrial.
- Juntas em casas de banho e cozinhas.
- Aplicações sanitárias.

Designação	Cor	Volume		PREÇO / Unidade
MULTIBOND - MS35	Branco	290 ml	12	6,00
	Cinza			
	Preto			
	Terracota			
MULTIBOND - 35 - CLEAR	Cristal	290 ml	12	8,00

**SILICONE PARA ALTAS TEMPERATURAS
"SILIRUB HT-N"**

SOUDAL



DESCRIÇÃO: SILIRUB HT-N é um selante monocomponente de cura neutra, com elasticidade permanente, à base de silicões, com elevada resistência à temperatura .

CARATERISTICAS:

- Excelente aplicação
- Estável a alta temperatura (até 285 °C)
- Elasticidade persistente depois de seco
- Excelente resistência ao raios UV
- Excelente aderência em vários materiais, como vidro, cerâmica, esmalte, metais, etc.

Estável até 285 °C

APLICAÇÕES:

Toda a aplicação que requer estabilidade a altas temperaturas, nomeadamente:
-Selagem de juntas de cárter; -Selagem em equipamentos de bombagem e motores; -Selagem em caldeiras; -Selagem em fornos e placas de fogão.

Designação	Cor	Volume		PREÇO / Unidade
SILIRUB HT-N	Preto	310 ml	15	12,70

**SILICONE PARA ALTAS TEMPERATURAS
"GASKET SEAL"**

SOUDAL



DESCRIÇÃO:

Formador de juntas de silicone específico para peças metálicas.

CARATERÍSTICAS:

- Resiste a temperaturas até +285 °C;
- Elasticidade permanente;
- Reticulação acética;
- De fácil aplicação.

Resiste até 285°C

APLICAÇÕES:

• Colagem de peças metálicas; • Colagem de bombas e motores; • Colagens em caldeiras de aquecimento.

Designação	Cor	Volume		PREÇO / Unidade
GASKET SEAL	Roxo	310 ml	12	12,20

**MASSA REFRACTÁRIA
"CALOFER"**

SOUDAL



DESCRIÇÃO:

Massa refractária resistente até 1500 °C.

CARATERÍSTICAS:

- Endurecimento e resistente a temperaturas até 1500 °C;
- Não é recomendada para juntas com movimentos.

Resiste até 1500 °C

APLICAÇÕES:

• Utiliza-se especialmente para uniões e gretas expostas a muito altas temperaturas em alvenaria, betão e metal;
• Pode-se usar para montagem e reparação de estufas, fornos, chaminés, sistemas de aquecimento e barbecues.

Designação	Cor	Volume		PREÇO / Unidade
MASSA REFRACTÁRIA "CALOFER"	Cinza Antracite	310 ml	24	5,30



DESCRIÇÃO:

Massa selante acrílica para preenchimento de juntas e fissuras, pintável, isento de estireno, para aplicação em interiores e exteriores, cor branca.

CARACTERÍSTICAS:

- Acryl flex é um selante plastoelástico monocomponente para juntas, à base de dispersões acrílicas.
- Graças à sua composição única, minimiza o risco de fissuras, mesmo em tintas muito cheias e opacas.
- Muito simples de aplicar, indelével e resistente à água após solidificação. Pintável após solidificação, possui excelente aderência em diversas superfícies porosas e alumínio.
- não fissura.

APLICAÇÕES:

- Juntas de ligação no setor da construção de baixo movimento até 12,5%;
- Juntas em peitoris de janelas, entre rodapés, paredes e tetos, entre alvenarias...;
- Vedações várias tais como, caixas estore, aros de portas e janelas...;
- Acabamento de juntas e espaços em superfícies porosas que necessitem de pintura.

DADOS TÉCNICOS:

- Material: base acrílica
- Cor: branca
- Embalagem: cartucho 300ml
- aplicação: à pistola

Designação	Cor	Volume		PREÇO / Unidade
ACRYL FLEX	Branco	300 ml	12	1,90

TAPA GRETAS "ACRYRUB N"

SOUDAL



DESCRIÇÃO:

Selante acrílico em dispersão de primeira qualidade para juntas e acabamentos pintáveis.

Pintável

CARATERÍSTICAS:

- Excelente aderência sobre todos os materiais de construção;
- Para interior e exterior;
- Pintável;

APLICAÇÕES:

- Reparação de gretas; • Colagem de juntas em carpintaria e mármore.

Designação	Cor	Volume		PREÇO / Unidade
ACRYRUB	Branco	310 ml	24	2,70
	Cinza			

"TAPA-GRETAS" AREADO REPA-CRYL D

SOUDAL



DESCRIÇÃO:

REPACRYL-D é um selante plasto-elástico mono-componente de elevada qualidade à base de dispersões acrílicas.

Acabamento areado

CARATERÍSTICAS:

- Acabamento areado. • Sem perda de volume depois de seco. • Impermeável depois de seco. • Pintável depois de seco. • Excelente aderência à maioria dos materiais porosos.

APLICAÇÕES:

- Reparação de fissuras (ex. trabalhos em gesso); • Juntas de peitoril de janelas, entre rodapés e o solo, entre alvenaria, etc; • Juntas entre carpintaria e alvenaria na indústria de construção.

Designação	Cor	Volume		PREÇO / Unidade
REPA-CRYL D	Branco	310 ml ALU	15	5,00

REPAIR EXPRESS

SOUDAL

TAPA E REPARA FENDAS, ORIFÍCIOS, IMPERFEIÇÕES

DESCRIÇÃO:

Repair Express Plaster é um composto de selagem e de enchimento, de alta qualidade, para uma reparação fácil e sem abatimento, ou para enchimento de fendas e de buracos em paredes e tetos.



CARATERÍSTICAS:

- Acabamento suave; - Cura muito rápida; - Não encolhe; - Pode ser lixado após a cura; - Pode ser pintado num curto espaço de tempo (após 15 minutos até um par de horas, dependendo da quantidade de produto utilizado); - Muito boa adesão sobre muitos materiais porosos.



Designação	Cor	Volume		PREÇO /Unidade
REPAIR EXPRESS	Branco	250 ml	12	8,00
		900 ml	6	17,00

T-REX

Indústria e construção

SOUDAL

FORÇA EXTREMA



Exterior, interior, flexível, elevada força inicial, resistente à água, sem pressão mecânica, sem solventes, pintável, dentro de água, antifungos, colagem extrema, resistência ao desgaste, resistência aos raios UV.



**POLIVALÊNCIA
A COLAR E VEDAR**

FORÇA INVISÍVEL



Transparente, exterior, interior, Sem solventes, flexível, pintável, resistente à água, sem pressão mecânica, dentro de água, resistência aos raios UV, colagem extrema, resistência ao desgaste.



**TRANSPARÊNCIA
NA SELAGEM**

RAPIDEZ EXTREMA



Exterior, interior, flexível, resistente à água, sem pressão mecânica, sem solventes, pintável, antifungos, dentro de água, colagem extrema, resistência ao desgaste, resistência aos raios



**RAPIDEZ
NA SECAGEM**

FORÇA INICIAL



Força inicial extrema, Exterior, interior, flexível, resistente à água, sem pressão mecânica, sem solventes, pintável, antifungos, dentro de água, colagem extrema, resistência ao desgaste, resistência aos raios UV.



**AGARRE INICIAL
E RAPIDEZ EXTREMA**

FORÇA FLEXÍVEL



T-Rex Flex é um selante e adesivo de alta qualidade para juntas na construção, neutro, elástico, mono componente à base de Polímero Híbrido SMX. Resistência aos raios UV.



**FLEXIBILIDADE
A COLAR E VEDAR**



FLEXÍVEL



PINTÁVEL



DEBAIXO DE ÁGUA



INODORO



INTERIOR E EXTERIOR



SANITÁRIO

Designação	Cor		Volume	PREÇO / Un.
T-REX POWER	Branco	12	290 ml	16,24
	Cinza			
	Preto			
	Bege			
	Terracota			
	Clear / Transparente			16,88
T-REX CRISTAL / VIDRO	Transparente	12	290 ml	16,88
T-REX TURBO	Branco	12	290 ml	17,02
T-REX X-TREME	Branco	12	280 ml	16,88
T-REX FLEX	Branco	12	290 ml	13,16

T-REX FLOOR & WALL

SOUDAL



DESCRIÇÃO:

Cola de **polímero híbrido** para pavimentos e paredes. Adesivo à base da **tecnologia de polímero SMX** pronto a usar, flexível e de elevada qualidade, Especialmente desenvolvido para colagem de elevado desempenho de superfícies **verticais** e **horizontais**. Adequado para todas as superfícies, porosas e não porosas e de pedra natural.

CARATERÍSTICAS:

- Pode ser usado em condições húmidas;
- Muito boa aderência à maioria das superfícies (porosas e não porosas);
- Sem isocianatos, solventes, halogéneos e ácidos;
- Pode ser pintado em húmido com tintas à base de água;
- Aplicações sanitárias;
- Aplicação universal;
- Não mancha superfícies porosas: pedra natural, mármore, ...;
- Fácil de manusear, mesmo em circunstâncias difíceis.

APLICAÇÕES:

- Colagem de todo o tipo de materiais de construção sobre superfícies porosas e não porosas.
- Aplicações horizontais: todo o tipo de pavimentos, ladrilhos, carpete, ...
- Aplicações verticais: todo o tipo de paredes, azulejos de parede, torneados decorativos, painéis inox, ...

Designação	Cor	Embalagem		PREÇO / Unidade
T-REX FLOOR & WALL	Branco	Balde 4 kg	1	95,44

T-REX CLEANER

SOUDAL



Use **T-REX CLEANER** na preparação, limpeza e acabamento para um **RESULTADO EXTREMO**

Indústria e construção

Produto de limpeza e de desengorduramento, não deixa resíduos, secagem rápida, para todos os tipos de trabalho de manutenção, selagem e montagem.

Designação	Cor	Volume		PREÇO / Unidade
T-REX CLEANER		400 ml	6	9,54

COLA DE CONTACTO LÍQUIDA - 44A

Soudal

DESCRIÇÃO:

Cola de Contato Líquida (44A) é uma cola de contacto à base de borracha e resinas sintéticas, universal, sem tolueno, com solventes e pronta a usar.

CARATERÍSTICAS:

- Secagem rápida
- Elevada força adesiva
- Resistente à humidade

APLICAÇÕES:

- Colagem de diferentes materiais como borracha, pele, cortiça, plástico, feltro, etc. sobre diversos tipos de superfícies.
- Colagem de painéis sintéticos decorativos e remates em madeira, metal ou cartonados.

- Carpintaria
- Montagem
- Indústria



Embalagem	Ref. ^a		PREÇO/Un
Bisnaga 50 ml	131975	12	3,00
Bisnaga 125 ml	131974	12	4,00

COLA DE CONTACTO GEL - 46A

Soudal

DESCRIÇÃO:

46A Cola de Contacto em GEL é uma cola tixotrópica universal com solventes, sem tolueno, pronta a usar, à base de resinas sintéticas e de borracha.

CARATERÍSTICAS:

- Secagem rápida
- Elevada força adesiva
- Resistente à humidade

APLICAÇÕES:

- Colagem de diversos materiais, como borracha, couro, cortiça, plástico, feltro, etc. sobre variados tipos de substratos ou entre si.
- Colagem de painéis decorativos sintéticos e bancadas de trabalho em madeira, metal ou cartão.

- Carpintaria
- Montagem
- Indústria



Embalagem	Ref. ^a		PREÇO/Un
Bisnaga 50 ml	131978	12	3,20
Bisnaga 125 ml	131977	12	4,30

COLA DE CONTACTO SPRAY

Soudal

DESCRIÇÃO:

Cola de Contacto em SPRAY é uma cola de contacto em aerossol à base de borracha sintética.

CARATERÍSTICAS:

- Para colagem permanente ou temporária
- Pronta a usar e muito fácil de usar
- Rápido processo de secagem
- Boa aderência sobre muitos materiais
- Colagem ao toque muito rápida

APLICAÇÕES:

- Colagem de produtos em papel
- Para a colagem de uma ampla gama de materiais (não é indicado para superfícies irregulares)
- Adequada para a rápida colagem de p.e. plásticos, metal, madeira, porcelana, cortiça, couro, cerâmicas, cartão, papel e borracha

- Carpintaria
- Montagem
- Indústria



Embalagem	Ref. ^a		PREÇO/Un
Spray 300 ml	136979	6	7,70

SILICONE LÍQUIDO HYDROBLOCK WET TECNOLOGIA SMX

SOUDAL



MEMBRANA LÍQUIDA TECNOLOGIA SMX®

APLICÁVEL EM SUPERFÍCIES HÚMIDAS E RESISTENTE À ÁGUA ESTAGNADA
Para a renovação, reparação, proteção e impermeabilização elástica e duradoura de todas as superfícies e materiais.



TELHADOS, CALEIRAS, COBERTURAS, CHAMINÉS, CLARABOIAS, TERRAÇOS, VARANDAS, FLOREIRAS, BASES DE DUCHE, ...

VANTAGENS RELATIVAMENTE AO



- Adere sobre superfícies húmidas;
- Pintável.



Reparação de telas
asfálticas. Reparação de
uniões em saídas de
ventilação.



Reparação,
impermeabilização de
fachadas.



Reparação em uniões de
chaminés.

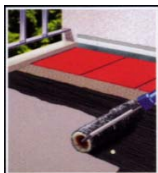

Impermeabilização de
superfícies planas.



Impermeabilização de
coberturas inclinadas.
Reparação de infiltrações
em telhados.



Reparação de caleiras.

APLICÁVEL COM:



Mãos e ferramentas podem
lavar-se com água

Hydro Block Wet Kit 1 kg



- Inclui:
- Balde para aplicação com rolo;
 - Trincha de 40 mm;
 - Soudatextile: malha não tecida (15x30cm);
 - Luvas descartáveis

COR	BALDE		PREÇO	
			€/Kg	€/balde
Telha	1 Kg	6	25,00	25,00
	5 Kg	1	18,00	90,00
	10 Kg	1	16,00	160,00
Cinza	1 Kg	6	25,00	25,00
	5 Kg	1	18,00	90,00
	10 Kg	1	16,00	160,00
Branco	1 Kg	6	25,00	25,00
	5 Kg	1	18,00	90,00
	10 Kg	1	16,00	160,00
Preto	1 Kg	6	25,00	25,00
	5 Kg	1	18,00	90,00
	10 Kg	1	16,00	160,00

PELE ELÁSTICA HYDROBLOCK DRY

SOUDAL



PELE ELÁSTICA

APLICÁVEL EM SUPERFÍCIES SECAS E NÃO RESISTENTE A ÁGUA ESTAGNADA.
Para a impermeabilização, reparação e renovação de todas as superfícies e materiais.



TELHADOS, CALEIRAS, COBERTURAS, CHAMINÉS, CLARABÓIAS, TERRAÇOS, VARANDAS, ...



RESISTENTE
AOS RAIOS UV



PINTÁVEL



NÃO ESCORRE



PREENCHE E
VEDA FISSURAS



SECAGEM
APÓS 24H



VISITÁVEL

BENEFÍCIOS

- Pronto a usar
- Fácil de aplicar
- Adesão sem primários
- Poder de preenchimento
- Não escorre
- Aplicação em superfícies verticais e horizontais
- Adequado para pequenas ou grandes áreas
- Secagem em 24h
- Elástico
- Pintável
- Visitável (P2)
- Resistente aos raios UV e à intempérie
- Durabilidade mínima de 5 anos

HYDROBLOCK DRY é uma membrana líquida de base acrílica, para a renovação, reparação, proteção e impermeabilização elástica e duradoura de todo o tipo de coberturas, caleiras, clarabóias, terraços e varandas visitáveis. É aplicável em superfícies secas e sem possibilidade de água estagnada e com uma durabilidade de 5 anos.

APLICÁVEL COM:



Mãos e ferramentas podem lavar-se com água

	COR	BALDE		PREÇO	
				€/Kg	€/balde
Telha		5 Kg	1	7,40	37,00
		18 Kg	1	6,11	110,00
Cinza		5 Kg	1	7,40	37,00
		18 Kg	1	6,11	110,00
Branco		5 Kg	1	7,40	37,00
		18 Kg	1	6,11	110,00

HIDRORREPELENTE HYDROBLOCK CLEAR

SOUDAL



TRATAMENTO HIDRÓFUGO INVISÍVEL

HIDRORREPELENTE DE BASE SOLVENTE

Atribui propriedades de repelência à água sem alterar o aspeto natural dos materiais de construção minerais porosos, alvenaria de tijolo, pedras naturais porosas, telhas e cimento



TELHADOS E PAREDES POROSOS, SEM PINTAR

COR	BALDE		PREÇO	
			€/L	€/balde
Translucido	5 L	4	12,00	60,00
	25 L	1	10,40	260,00

FITA ADESIVA DE BUTILO HYDROBLOCK BAND

SOUDAL



FITA ADESIVA DE BUTILO

FITA DE REPARAÇÃO UNIVERSAL

Selagem de chaminés, condutas de ar, clarabóias, aros de janelas e portas deslizantes.



COR	LARGURA x COMPRIMENTO		PREÇO	
			€/Rolo	
Alumínio	7,5 cm x 10m	8	18,00	
	10 cm x 10m	6	25,00	
	15 cm x 10m	4	36,00	
	22,5 cm x 10m	2	54,00	
	30 cm x 10m	2	71,00	

TRATAMENTO ANTI-FUNGOS HYDROBLOCK CLEAN

SOUDAL



TRATAMENTO ANTI-FUNGOS

SOLUÇÃO AQUOSA PARA O TRATAMENTO PREVENTIVO E CURATIVO DE MUSGOS, LÍQUENES E ALGAS. Elimina microorganismos sobre todo o tipo de materiais: tijolo, betão, cimento, fibrocimento, pedra. Ideal antes de aplicar impermeabilizantes.



TELHADOS, PAREDES, PAVIMENTOS, JARDINS, TERRAÇOS, BARCOS, RESERVATÓRIOS, ...



COR	BALDE		PREÇO	
			€/L	€/balde
Translucido	1 L	6	11,00	11,00
	5 L	1	6,00	30,00

SPRAY LUBRIFICANTE MULTIFUNCIONAL - "O1L"

SOUDAL



500 ml
com válvula "Genius"



200 ml
com caixa expositor

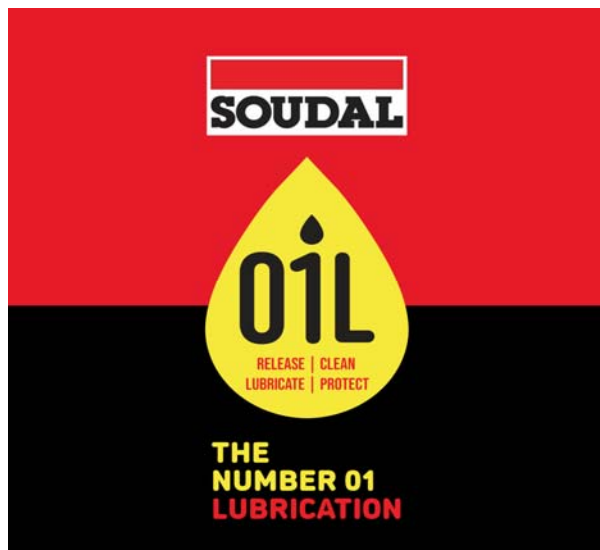

Desbloquear, Limpar, Lubrificar e Proteger 4 funções num só aerossol



Desbloquear

Devido à sua fórmula inovadora, o **O1L** permite desbloquear até as engrenagens mais difíceis, mantendo as peças a funcionar perfeitamente e removendo a ferrugem com grande eficiência. Com grande efeito de penetração, o **O1L** desbloqueia até as peças mais calcinadas e enferrujadas, sendo ideal para trabalhos mais exigentes.



Limpar

Com um forte mecanismo de saída do spray, o **O1L** atua como um potente limpador. A sua composição especialmente formulada para repelir humidade, mantém todas as partes elétricas em funcionamento, mesmo nas condições mais adversas. Elimina restos de colas, gorduras ou sujidade das superfícies. A combinação de todos os componentes do **O1L** representa uma verdadeira revolução contra a remoção de ferrugem e limpeza dos mais variados objetos. O **O1L** deixa os seus metais a brilhar e com aspeto novo. Renova os plásticos e borrachas, deixando-os com uma aparência reluzente.



Lubrificar

O **O1L** mantém as engrenagens, fechos, fechaduras, correntes, e todo o tipo de metais, borrachas ou plásticos tais como calhas ou rolamentos, a funcionar perfeitamente, sem ruídos e dificuldades. Ideal para aqueles barulhos incómodos e para todas as peças que necessitem movimento no seu funcionamento tais como dobradiças ou fechaduras. Com grande poder de viscosidade, o seu efeito de lubrificação é mais duradouro, resistindo às intempéries e condições mais exigentes, durante mais tempo. Não terá mais de se preocupar com corrosão ou oxidação dos materiais.



Proteger

Devido à sua fórmula especial, o **O1L** tem um efeito de proteção mais duradouro, deixando uma camada resistente às intempéries, protegendo múltiplas superfícies, engrenagens, cablagens, metais, prolongando a vida das suas ferramentas, máquinas e mecanismos. O **O1L** é ideal para as dobradiças das portas e janelas, para o automóvel, peças industriais, portões de garagem, ..., um infinito número de aplicações. Protege contra a oxidação e corrosão. Não contém silicone. Não ataca as borrachas, plásticos ou pintura.

Designação	Volume		PREÇO / Unidade
SPRAY LUBRIFICANTE MULTIFUNCIONAL - "O1L"	200 ml	12	5,08
	500 ml	15	9,28

PISTOLAS PARA SILICONE



Ref.^a C802A

Bricolage



CARACTERÍSTICAS:

- Qualidade bricolage;
- Para cartuchos de silicone de 310 ml;
- Taxa de impulso 6:1;
- Força de impulso > 1000 N
- Êmbolo liso - sem serrilha;
- Corpo, gatilho e punho em metal.

	PREÇO
1	4,00

Ref.^a C803C

Bricolage / Aplicador



CARACTERÍSTICAS:

- Qualidade bricolage / profissional;
- Para cartuchos de silicone de 310 ml;
- Taxa de impulso 10:1;
- Força de impulso > 1500 N
- Êmbolo serrilhado para uma forte extrusão;
- Com corta-bicos e desentupidor de bicos;
- Corpo, gatilho e punho em metal.

	PREÇO
1	6,50

Ref.^a C821

Semi-Profissional



CARACTERÍSTICAS:

- Qualidade semi-profissional;
- Para cartuchos de silicone de 310 ml;
- Taxa de impulso 12:1;
- Força de impulso > 2000 N
- Placa de impulso em aço sinterizado;
- Corpo rotativo;
- Corpo, gatilho e punho em metal.

	PREÇO
1	11,00

Ref.^a C1330 B

Profissional



CARACTERÍSTICAS:

- Qualidade profissional;
- Para cartuchos de silicone de 310 ml;
- Taxa de impulso 18:1;
- Força de impulso > 3000 N
- Placa de impulso em aço sinterizado;
- Corpo rotativo;
- Corpo, gatilho e punho em metal.

	PREÇO
1	15,00

Ref.^a C1342-15

15" - Para «Salsichão»



CARACTERÍSTICAS:

- Qualidade profissional;
- Para bolsas de silicone "Salsichão" - 15" - 600 ml;
- Taxa de impulso 16:1;
- Força de impulso > 3000 N
- Placa de impulso em aço sinterizado;
- Corpo em alumínio;
- Gatilho e punho em metal.

	PREÇO
1	24,00

PISTOLAS PARA ESPUMA DE POLIURETANO



Ref.^a 904B

0% Resíduos
de espuma na lata

Não necessita limpeza
entre aplicações



CARACTERÍSTICAS:

- Qualidade profissional;
- 0% de resíduos de espuma na lata;
- Comodidade e durabilidade:
- Não é necessária limpeza depois de usar. Basta bloquear a agulha de selagem (com a lata montada na pistola), até 30 dias após, abrir a agulha de selagem e a pistola funciona normalmente;
- Botão rotativo de ajuste de fluxo seguro;
- Aprovação CE.

Embalagem		PREÇO
Blister	1	13,00
Caixa	1	12,00

Ref.^a 1324T8

0% Resíduos
de espuma na lata

Não necessita limpeza
entre aplicações



CARACTERÍSTICAS:

- Qualidade profissional;
- 0% de resíduos de espuma na lata;
- Comodidade e durabilidade:
- Não é necessária limpeza depois de usar. Basta bloquear a agulha de selagem (com a lata montada na pistola), até 30 dias após, abrir a agulha de selagem e a pistola funciona normalmente;
- Botão rotativo de ajuste de fluxo seguro;
- Com bola de não-retorno em PTFE;
- Aprovação CE.

Embalagem		PREÇO
Caixa	1	26,00

PISTOLAS PARA RESINA



Ref.^a C1360



Peso: 1 135 g

CARACTERÍSTICAS:

- Qualidade profissional;
- Para cartuchos de 400 ml - coaxiais de 2 componentes;
- Taxa de impulso 25:1;
- Força de impulso > 3000 N
- Corpo, gatilho e punho em metal.

Embalagem		PREÇO
	1	20,00

Ref.^a C1560



Ultra leve
(construída em
liga de Magnésio)

Peso: 600 g

CARACTERÍSTICAS:

- Qualidade profissional;
- Para cartuchos de 400 ml - coaxiais de 2 componentes;
- Taxa de impulso 25:1;
- Força de impulso > 4000 N
- Corpo, gatilho e punho em metal.

Embalagem		PREÇO
	1	31,00

LOCTITE
"SUPER COLA 3"
Cola Universal Instantânea



ORIGINAL (N.º 1)



Aplicação:
 Loctite Super Cola-3 Nº 1 Líquido possui a máxima força de união, colando em poucos segundos qualquer tipo de material: PORCELANA, MADEIRA, PLÁSTICO, METAL, BORRACHA, COURO, MÁRMORE...

Vantagens:

- Máxima força de união
- Tampa antiobstrução

Formato:

- Tubo 3 g (blister)

DESIGNAÇÃO		PREÇO / Un.
LOCTITE SUPER COLA 3 - ORIGINAL	12	5,10

PRECISÃO



Aplicação:
 Loctite Super Cola-3 Precisão possui a máxima força de união, colando em poucos segundos qualquer tipo de material: PORCELANA, MADEIRA, PLÁSTICO, METAL, BORRACHA, COURO, MÁRMORE...

Vantagens:

- Fácil regulação do gotejamento que permite obter uma PRECISÃO absoluta.
- Ponta de aplicação extralonga que permite chegar a zonas de acesso mais difícil.

Formato:

- Embalagem 5 g (blister)

DESIGNAÇÃO		PREÇO / Un.
LOCTITE SUPER COLA 3 - PRECISÃO	12	7,60

PINCEL



Aplicação:
 Loctite Super Cola-3 Com Pincel possui a máxima força de união, colando em poucos segundos qualquer tipo de material: PORCELANA, MADEIRA, PLÁSTICO, METAL, BORRACHA, COURO, MÁRMORE...

Vantagens:

- Revolucionário pincel que permite aplicar o produto de modo limpo e seguro.
- Embalagem totalmente estável que permite tê-lo sempre à mão em qualquer lugar.
- Tampa de fácil abertura.

Formato:

- Tubo 5 g (blister)

DESIGNAÇÃO		PREÇO / Un.
LOCTITE SUPER COLA 3 - COM PINCEL	12	8,70

PROFISSIONAL



Aplicação:
 Loctite Super Cola-3 Profissional possui a máxima força de união, colando em poucos segundos qualquer tipo de material: PORCELANA, MADEIRA, PLÁSTICO, METAL, BORRACHA, COURO, MÁRMORE...

Vantagens:

- Alto rendimento, uso muito frequente.
- Especialmente indicado para grandes superfícies.

Formato:

- Embalagem 20 g (blister)

DESIGNAÇÃO		PREÇO / Un.
LOCTITE SUPER COLA 3 - PROFISSIONAL	12	18,00

VIDRO



Aplicação:
 Loctite Super Cola-3 Vidro é uma cola instantânea específica para colagem de vidro com vidro e vidro com metal em menos de um minuto e sem necessitar de luz solar. Cola vidro de qualquer espessura ou cor, sendo também a cola ideal para colar espelhos retrovisores.

Vantagens:

- Cola vidro em segundos.
- Totalmente transparente.
- Resistente à máquina de lavar louça.

Formato:

- Embalagem 3 g (blister)

DESIGNAÇÃO		PREÇO / Un.
LOCTITE SUPER COLA 3 - VIDRO	12	7,00

CONTROL



Aplicação:
 Loctite Super Cola-3 Control possui a máxima força de união, colando em poucos segundos qualquer tipo de material: PORCELANA, MADEIRA, PLÁSTICO, METAL, BORRACHA, COURO, MÁRMORE...

Vantagens:

- Exclusivo Press Control System que permite uma dosagem exacta gota a gota.
- Fecho de segurança com sistema de bloqueio com duplo click.
- Embalagem antichoque que assegura uma conservação óptima do produto.

Formato:

- Embalagem 3 g (blister)

DESIGNAÇÃO		PREÇO / Un.
LOCTITE SUPER COLA 3 - CONTROL	12	6,50

LOCTITE
"SUPER COLA 3"
Cola Universal Instantânea



PURE GEL



CARACTERÍSTICAS



Fórmula não goteja

A sua fórmula de maior viscosidade, permitindo obter um resultado perfeito inclusive em aplicações verticais.

Superfícies porosas

Especialmente indicado para aplicações sobre superfícies porosas, já que o produto fica na superfície.

Poder de enchimento

A sua fórmula de enchimento oferece uma melhor resposta em superfícies irregulares ou que não alinham perfeitamente.

Aplicação:

Loctite Super Cola-3 Gel possui a máxima força de união, colando em poucos segundos qualquer tipo de material: PORCELANA, MADEIRA, PLÁSTICO, METAL, BORRACHA, COURO, MÁRMORE...

Vantagens:

- Máxima força de união.
- Permite rectificar a união durante os primeiros 10 seg.
- Não goteja, pelo que é ideal para qualquer aplicação inclusive em superfícies verticais.
- Perfeita para materiais porosos, já que o produto fica na superfície e o poder de união é maior.
- Recomendada para superfícies rugosas, permite preencher todos os recantos que possam existir entre as superfícies a colar.

Formato:

- Tubo 3 g em embalagem de cartão - sem plástico.

DESIGNAÇÃO		PREÇO / Un.
LOCTITE SUPER COLA 3 - PURE GEL	12	6,00

POWER FLEX GEL

A REVOLUÇÃO
EM COLAS
INSTANTÂNEAS

Loctite Super Cola 3 Power Flex Gel é uma cola instantânea extra forte que se adapta aos materiais flexíveis graças à sua fórmula enriquecida com partículas de borracha.



- Flexível
- Preciso, Não goteja
- Resistente a golpes e vibrações
- Extra forte
- Multimateriais
- Transparente



DESIGNAÇÃO		PREÇO / Un.
LOCTITE SUPER COLA 3 - POWER FLEX GEL 3g (blister)	12	6,00

Cola especial para PVC rígido "COLA ESPECIAL PVC"



CARACTERÍSTICAS:

Cola para tubagens e acessórios de PVC em instalações de saneamento, rega e construção em geral.

É composto por uma solução de PVC em combinação com aditivos especiais e solventes orgânicos que lhe conferem propriedades como tixotropia, estabilidade e longevidade. Actua fisicamente sobre o PVC dissolvendo a zona superficial e formando um corpo entre a cola e o PVC. A sua estrutura tixotrópica permite preencher tolerâncias e, desta forma, obter uma colagem perfeita.

As uniões realizadas duram tanto tempo como a tubagem.



MATERIAIS:

- Tubagens e acessórios em PVC.

APLICAÇÕES:

- Cola especial para uniões resistentes e duradouras em uniões de tubagens, acessórios, placas e perfis em PVC rígido. Indicado para colar tubagens em conduções de pressão em instalações industriais, esgotos, águas pluviais, água potável, colagem de peças de PVC em carpintaria de PVC, canalização de cabos, etc.

Cola especial para PVC é ainda indicada para tubagens de escoamento em ABS/ASA.

Embalagem		PREÇO/Un
Bisnaga 125 g	72(12x6)	6,80
Lata 250g c/ pincel	12	14,00
Lata 500g	12	21,50

Produto de limpeza para uniões de PVC rígido "PRODUTO DE LIMPEZA PVC"



CARACTERÍSTICAS:

Produto especial para limpar tubagens de PVC destinadas a serem coladas com Tangit Cola Especial para PVC em trabalhos de grande responsabilidade.

- Grande poder de limpeza
- Contém solvente de limpeza
- Seca sem deixar resíduos
- Não contém solventes clorados.



MATERIAIS:

- Tubagens e acessórios em PVC.

APLICAÇÕES:

- Agente de limpeza para tubagens e acessórios de PVC-U, PVC-C e ABS.
- Deve ser utilizado antes de se realizarem uniões de PVC-U com Tangit Cola Especial.
- Não é adequado para limpar tubagens de PE, PP, ou PVDF.

Embalagem		PREÇO/Un
Lata 0,5 L	24	12,00
Lata 1 L	12	22,00

Vedante de roscas universal "UNI-LOCK" - EM FIO -



CARACTERÍSTICAS:

Tangit Uni-Lock é um vedante universal, apropriado para uniões de tubagens roscadas plásticas e/ou metálicas.

MATERIAIS:

- Tubagens roscadas plásticas e/ou metálicas.

APLICAÇÕES:

- É particularmente recomendado em situações em que seja necessário colocar as tubagens imediatamente em funcionamento após a união, seja qual for a pressão de serviço. Permite ainda o reajuste das roscas em qualquer altura sem que haja risco de fugas. As uniões podem ser desmontadas e as roscas reutilizadas.

É adequado para todo o tipo de tubagem roscada, rígida ou flexível, plástica (PE, PP, PVC, ABS) ou metálica (aço, aço inox, cobre, bronze, latão, metais cromados, niquelados e galvanizados).
Recomendado para conduções de água quente ou fria, água potável, gás, fluidos de refrigeração, aços e bases diluídos. Não é recomendado para conduções de oxigénio ou cloro puros, gasóleo, gasolina e fuelóleo. Resiste ao choque e às vibrações. O produto não migra nem retrai.

HOMOLOGADO PARA
GÁS E AQUECIMENTO



Embalagem		PREÇO/Un
Dispensador 80 m	20	13,60
Dispensador 160 m	20	19,50

Vedante de roscas metálicas "METALOCK"



CARACTERÍSTICAS:

Vedante de roscas anaeróbico para tubagens metálicas (**roscas metal-metal**).

- Veda imediatamente todos os líquidos e gases até 30 bar (excepto oxigénio ou cloro puros).
- Para roscas metálicas até 3" de diâmetro. • Endurece rapidamente (± 15 min).
- Lubrifica ao enroscar eliminando os atritos e facilitando o aperto.
- Trabalho mais limpo e seguro. • Facilmente desmontável em roscas até 1,5" de diâmetro.
- Resiste a temperaturas entre -55 e $+150$ °C. • A rosca permanece reutilizável.
- Rendimento de um frasco de 50 ml: 150 uniões de 1/2".

MATERIAIS:

- Tubagens e acessórios metálicos roscados.

APLICAÇÕES:

- Indicado para vedar uniões roscadas de tubagens metálicas até 3" de diâmetro. Apto para aplicações sobre aço, cobre, latão, bronze, níquel, ferro, alumínio e aço inoxidável.
- Mais prático e seguro que qualquer fita de PTFE (teflon) ou linho, Tangit Metalock assegura uma perfeita estanquicidade entre as roscas metálicas. É adequado para conduções de gás, água potável, ar comprimido, fluidos de refrigeração, fuel, ácidos e bases diluídas.

HOMOLOGADO PARA
GÁS E AQUECIMENTO



Embalagem		PREÇO/Un
Frasco 50 ml	12	27,00

Vedante de roscas plásticas "PLASTICLOCK"



CARACTERÍSTICAS:

Vedante de roscas flexível, adequado para conseguir uma estanquicidade perfeita entre uniões roscadas de **plástico/plástico** e **plástico/metal**.

- Para roscas de todos os diâmetros. • Desmontável. Pode-se reutilizar a rosca.
- Veda imediatamente até 3 bar após 30 min. Resiste até 7 bar. Para pressões superiores, esperar 24 horas
- Rendimento: um tubo de 100 ml serve para 210 uniões de 1/2". • Reajustável até 30 min.

MATERIAIS:

- Tubagens roscadas plásticas ou plástico/metal (sistemas de rega).

APLICAÇÕES:

- Pode aplicar-se em roscas de tubos rígidos ou flexíveis. A sua utilização estende-se aos campos das tubagens roscadas de conduções agrícolas, industriais, domésticas, piscinas, drenagens, etc.
- Pode ser aplicado em conduções de água quente ou fria, água potável, ácidos e bases diluídos, etc.

É indicado para aplicar em tubagens de diversos tipos de plásticos (PE, PP, PVC, ABS), assim como sobre vários tipos de metais (aço, aço inox, cobre, bronze, latão, etc.). Resiste ao choque e às vibrações. O produto não migra nem retrai. Permite desmontar e reutilizar as roscas.

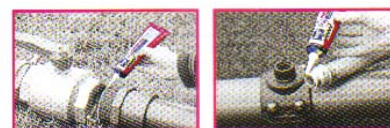

Embalagem		PREÇO/Un
Bisnaga 100 ml	12	16,00

FITA DE REPARAÇÃO MULTIUSOS "FIX IT"



DESCRIÇÃO:

Fita de borracha de silicone de autofusão, para reparações temporárias em mangueiras e tubos flexíveis.

CARACTERÍSTICAS:

- Resistente aos raios UV, água salgada, combustíveis e ácidos
- Fita não pegajosa
- Extensível até 3x
- Vedação instantânea
- Resistência à tração até 50 kg/cm²
- Resistência até 4bar de pressão
- Resistência dielétrica: 15kV/mm
- Intervalo de temperaturas: -54 °C a +260 °C



Vedante rápido e efetivo

Interior e exterior

Fácil de eliminar



Embalagem		PREÇO/Un
Rolo 3 metros	8	10,00

MASSA REPARADORA



Descrição:

TANGIT Massa Reparadora é uma massa adesiva rápida, especialmente desenvolvida para reparar e restaurar todo tipo de material de obra, canos metálicas e de PVC.

É ideal para reconstruir com a própria massa pequenos pedaços ou partes que podem faltar de numa peça ou superfície.

O produto adere sobre superfícies húmidas e endurece inclusivamente debaixo de água.

TANGIT Massa Reparadora amassa-se facilmente e adquire a consistência do metal uma vez endurecida.

Caraterísticas:

- Massa Rápida: endurece em 5 minutos
- Endurece debaixo de água
- Resistência à temperatura
- Não encolhe nem ganha fissuras
- Com partículas metálicas
- Para todo o tipo de materiais



Massa Adesiva Rápida

Resistente à temperatura

Repara - Preenche - Reconstrói



Embalagem		PREÇO/Un
Tubo 110g	12	17,00

FIXADOR DE ROSCAS METÁLICAS "NURAL 50"



É um produto formulado especialmente para fixar parafusos e porcas metálicas evitando que se afrouxem

CARACTERÍSTICAS:

- Cor: Vermelho.
 - Peso específico: 1,1 g/ml.
 - Viscosidade: 600-800 m Pa·s.
 - Largura óptima: 0,05 mm ou menor.
 - Tempo de endurecimento: 20 minutos.
 - Tempo até alcançar a resistência máxima: 12 horas.
- Temperaturas abaixo de 15°C aumentam estes tempos consideravelmente.

- Torque de desenroscagem: 17 Nm.
- Torque residual: 17 Nm.
- Resiste a temperaturas entre: -60°C e +150°C.
- Resistência a líquidos: Óleo de motor até 130°C, líquido de refrigeração até 90°C, gasolina, água e solventes habituais.

Suporta tracções extremas



APLICAÇÕES:

- Fixação de parafusos, escápolas, pernos, porcas, casquilhos, retentores, anilhas, rolamentos, tampas, eixos, poleias e demais elementos de fixação em bloco, culatra, carburador, transmissão, embraiagem, direcção, engrenagem, diferencial, travões, bombas de água, óleo e gasolina, dínamo e alternador.
- Não só serve como fixador como também actua como um excelente vedante em uniões de roscas e encaixes.

Embalagem		PREÇO/Un
Tubo 10 ml (blister)	12	9,00

FIXADOR DE ROSCAS METÁLICAS "NURAL 51"



Fixador de parafusos e porcas metálicas evitando que se afrouxem

CARACTERÍSTICAS:

- Cor: Azul.
 - Peso específico: 1,1 g/ml.
 - Viscosidade: 2000-2500 m Pa·s.
 - Largura óptima: 0,05 mm ou menor.
 - Tempo de endurecimento: 20 minutos.
 - Tempo até alcançar a resistência máxima: 3 horas.
- Temperaturas abaixo de 15°C aumentam estes tempos consideravelmente.

- Torque de desenroscagem: 24 Nm.
- Torque residual: 24 Nm.
- Resiste a temperaturas entre: -60°C e +150°C.
- Resistência a líquidos: Óleo de motor até 130°C, líquido de refrigeração até 90°C, gasolina, água e solventes habituais.

Fixação média:
Binário de aperto 24 Nm



APLICAÇÕES:

- É especialmente indicado para pernos de bombas e motores, porcas das válvulas, parafusos de tampas, e sempre que se preveja uma possível desenroscagem com ferramentas manuais. Pattex Nural 51 não só serve como fixador como também actua como um excelente vedante de uniões roscadas e junções.

Embalagem		PREÇO/Un
Frasco 24 ml	12	45,00

FIXADOR DE ROSCAS METÁLICAS "NURAL 53"



Fixador de parafusos e porcas metálicas evitando que se afrouxem devido às vibrações

CARACTERÍSTICAS:

- Cor: Verde.
 - Peso específico: 1,1 g/ml.
 - Viscosidade: 400-600 m Pa·s.
 - Tempo de endurecimento: 20 minutos.
 - Tempo até alcançar a resistência máxima: 6 horas.
- Temperaturas abaixo de 15°C aumentam estes tempos consideravelmente.

- Torque de desenroscagem: 40 Nm.
- Torque residual: 57 Nm.
- Resiste a temperaturas entre: -60°C e +150°C.
- Resistência a líquidos: Óleo de motor até 130°C, líquido de refrigeração até 90°C, gasolina, água e solventes habituais.

Fixação extrema:
Binário de afrouxamento 40 Nm



APLICAÇÕES:

- É especialmente indicado em condições de extrema exigência tais como parafusos em tampas e corpos do motor, parafusos em tampas e corpos de bombas e outros elementos de fixação onde se requeira a máxima resistência.

Embalagem		PREÇO/Un
Frasco 24 ml	12	45,00

Produto Multi-Use Original WD-40



200 ml

LUBRIFICANTE MULTIUSOS WD-40

A fórmula versátil e eficaz de WD-40 Produto Multi-Use Original torna-o uma ferramenta essencial na manutenção a nível industrial, profissional e doméstico!

Lubrifica

Lubrifica peças em movimento tais como dobradiças, rolamentos, correntes e engrenagens.

Renova

Limpa cromados e qualquer superfície metálica, eliminando também autocolantes e restos de pintura.

Repele a humidade

Repele a humidade dos quadros elétricos, velas e material elétrico em geral.

Desbloqueia

Penetra e liberta peças bloqueadas e oxidadas, tais como porcas, cadeados e pistões.

Protege

Protege contra a oxidação e corrosão.

Formatos

200 ml, 400 ml e 5 litros



400 ml

PRODUTO NOVO



5 litros

Utilizações intensivas industriais



Designação	Volume	Ref. ^a		PREÇO / Unidade
Produto Multi-Use Original WD-40 - SPRAY	200 ml	34102	12	6,31
		34120	6x20 (120)	6,31
	400 ml	34104	12	10,56
Produto Multi-Use Original WD-40 - BIDÃO (inclui borrifador com capacidade de 500 ml)	NOVO 5 litros	44506/E	1	64,49

Produto Multi-Useo
Dupla Ação e Flexível
WD-40



LUBRIFICANTE MULTIUSOS
DUPLA AÇÃO + FLEX
WD-40



**DUPLA
AÇÃO**
250 ml

**DUPLA
AÇÃO**
500 ml



FLEX
400 ml

O sistema inovador do formato WD-40 Produto Multi-Useo **Dupla Ação** permite alternar facilmente de uma aplicação ampla para uma precisa em apenas um click sem perder a cânula.

A cânula inovadora do formato WD-40 Produto Multi-Useo **Flexível** irá permitir aplicar o produto em lugares de difícil acesso poupando tempo e dinheiro! A cânula metálica é altamente resistente e pode ajustar-se para chegar aos sítios mais difíceis.

Lubrifica

Lubrifica peças em movimento tais como dobradiças, rolamentos, correntes e engrenagens.

Renova

Limpa cromados e qualquer superfície metálica, eliminando também autocolantes e restos de pintura.

Repele a humidade

Repele a humidade dos quadros elétricos, velas e material elétrico em geral.

Desbloqueia

Penetra e liberta peças bloqueadas e oxidadas, tais como porcas, cadeados e pistões.

Protege

Protege contra a oxidação e corrosão.

Formatos

DUPLA AÇÃO: 250 ml e 500 ml

FLEX: 400 ml

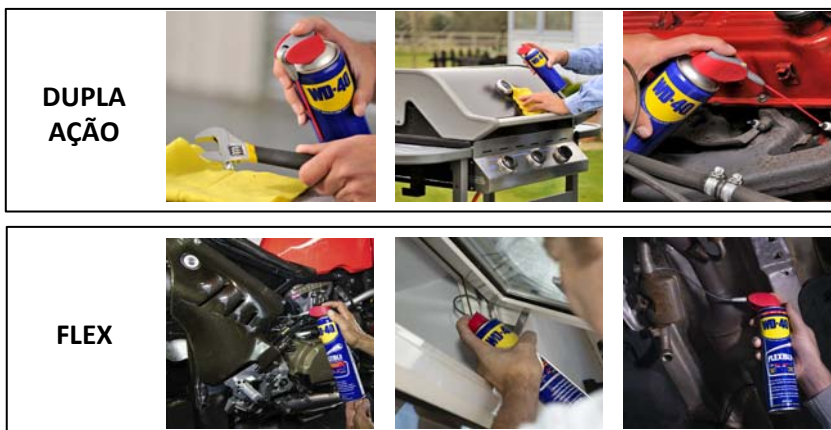

**DUPLA
AÇÃO**

FLEX

Designação	Ref. ^a	Volume			PREÇO / Unidade
Produto Multi-Useo DUPLA AÇÃO WD-40	34965	250 ml	6	6x12 (72)	8,00
	34134	500 ml	6		11,29
	34634			3x28 (84)	11,29
Produto Multi-Useo FLEX WD-40	34692	400 ml	6		12,42

Óleo de Corte Multiusos WD-40 Specialist®



ÓLEO DE CORTE MULTIUSOS PARA FERRAMENTAS DE CORTE E PERFURAÇÃO

A fórmula avançada do **WD-40 Specialist® Óleo de Corte Multiusos** foi especificamente desenvolvida para **maximizar o rendimento** das operações de corte e perfuração, ao mesmo tempo que **prolonga a vida útil** das ferramentas de corte. Este produto é ideal para profissionais e entusiastas do corte de metais, proporcionando uma lubrificação superior em condições de **pressão extrema**.

Pulverizador Dupla Ação

Recomendações de utilização

O óleo de corte **WD-40 Specialist®** é indicado para uma ampla gama de materiais, incluindo **aço inoxidável, titânio**, e outros metais, garantindo um **desempenho ideal** em operações de corte e perfuração exigentes.

Modo de utilização

O **WD-40 Specialist® Óleo de Corte** deve ser aplicado diretamente nas ferramentas e superfícies de corte para garantir uma **lubrificação adequada**. A fórmula foi desenhada para **maximizar a durabilidade da maquinaria** e **minimizar o desgaste** causado pelo uso contínuo em processos de **corte e perfuração**.

Produto	Volume		PREÇO / Unidade
Óleo de Corte Multiusos WD-40 Specialist®	400 ml	6	12,33

Penetrante Ação Rápida WD-40 Specialist®



PENETRANTE DE AÇÃO RÁPIDA PARA DESBLOQUEAR PEÇAS E MECANISMOS

O **WD-40 Specialist® Penetrante** foi desenvolvido para **penetrar e desbloquear** peças e mecanismos bloqueados pela **ferrugem** em questão de segundos. A sua fórmula avançada garante uma **ação eficaz** em áreas de difícil acesso, sendo a solução ideal para **soltar parafusos** e componentes corroídos.

Certificação e Compatibilidade

Com **certificação NSF H2**, o produto é seguro para uso em **equipamentos industriais** que não estejam em contacto direto com alimentos, sendo amplamente utilizado na **indústria alimentar** e outros setores.

Pulverizador Dupla Ação

Recomendações de Utilização

- **Resistência à água:** O **WD-40 Specialist® Penetrante** forma uma barreira protetora que **previne a formação de ferrugem e corrosão**, prolongando a vida útil dos componentes.
- **Baixa tensão superficial:** Graças à sua fórmula única, o penetrante alcança facilmente **áreas de difícil acesso**, garantindo uma lubrificação eficiente.
- Eficaz em temperaturas entre **-20 °C e +90 °C**.

Produto	Volume		PREÇO / Unidade
Penetrante Ação Rápida WD-40 Specialist®	400 ml	6	12,33

Desengordurante WD-40 Specialist®



WD-40 Specialist Desengordurante em Spray elimina rapidamente a sujidade mais persistente, como óleo, fuligem e gordura em segundos.

A fórmula com certificação **NSF K1** é apta para utilização como solvente de limpeza na indústria alimentar.

Usos recomendados

Limpa com eficácia óleo, sujidade e fuligem encrustados de superfícies metálicas.

Limpar antes de lubrificar qualquer superfície ou engrenagem é essencial para assegurar o bom funcionamento, reduzir o desgaste e prolongar a vida útil de todos os componentes.

Compatível com metais e vidro.

Pulverizador Dupla Ação

Instruções de utilização

Aplicar o produto na superfície a seco e deixar atuar durante uns segundos. De seguida limpar e passar um pano limpo para remover quaisquer resíduos e deixar a superfície limpa e seca.

Produto	Volume		PREÇO / Unidade
Desengordurante WD-40 Specialist®	500 ml	6	12,33

TECH AEROSOL

SPRAYS DE TINTA - SPRAYS TÉCNICOS

PRODUTOS DE LIMPEZA - ACESSÓRIOS



Gama completa de tintas e sprays técnicos de elevada qualidade para uso profissional no sector automóvel, oficinas, indústrias, náutica, climatização e escritórios.

GAMA DE PRODUTOS



PINTURAS

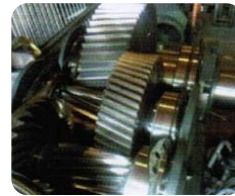

LUBRIFICANTES



ZINCANTES



MANUTENÇÃO



ISOLANTES



LIMPEZA



COLAS



ACESSÓRIOS

APLICAÇÕES



Indústria



Pichelaria



Casa/Jardim



Náutica



Escritório



Florestal



Tintas e ferramentas



Automóvel



SPRAYS DE TINTA

ESMALTE ACRÍLICO MULTIUSOS

**ESMALTE ACRÍLICO
MULTIUSOS**



CARACTERÍSTICAS

- Spray de esmalte acrílico;
- Secagem rápida;
- Adequado para aplicações interiores e exteriores;
- Garante um excelente recobrimento liso, uniforme e suave ao tacto;
- Resistente aos riscos;
- Longa duração;
- Ideal tanto para retoques como tratamento final de superfícies de natureza diversa: metal, madeira, plástico, vidro, etc...



Volume		PREÇO
400 ml	6	3,30

RAL	DESIGNAÇÃO
1003	Amarelo sinal
1007	Amarelo crómio
1013	Branco pérola
1014	Marfim
1015	Marfim claro
1021	Amarelo cádmio
1023	Amarelo trânsito
1028	Amarelo melão
2002	Laranja sangue
2003	Laranja pastel
2004	Laranja puro
2009	Laranja trânsito
3000	Vermelho fogo
3002	Vermelho carmim
3003	Bordeaux
3005	Vermelho vinho
3015	Cor-de-rosa
3020	Vermelho trânsito
4005	Lilás
5003	Azul safira
5005	Azul placa
5010	Azul genciana
5012	Azul claro
5015	Azul celeste
5017	Azul forte
6002	Verde folha
6005	Verde musgo / garrafa
6009	Verde erva

RAL	DESIGNAÇÃO
6011	Verde reseda
6018	Verde amarelado
6029	Verde menta
7001	Cinza prata
7011	Cinza ferro
7016	Cinza antracite
7025	Cinza pérola
7032	Cinza silício
7035	Cinza claro
7042	Cinza trânsito
8002	Castanho avelã
8004	Castanho cobre
8011	Castanho noz
8017	Castanho chocolate
9002	Branco cinza
9005	Negro brilhante
9005	Negro mate
9005	Negro acetinado
9006	Alumínio metalizado
9007	Cinza metalizado escuro
9010	Branco brilhante
9010	Branco mate
9010	Branco satinado
9016	Branco trânsito
9200	Branco electrodoméstico
9201	Transparente brilhante
9202	Transparente mate

TECH AEROSOL SPRAYS DE TINTA



ACESSÓRIOS SPRAYS DE TINTA

PISTOLA
PARA SPRAY



Spray
não
incluído

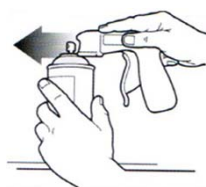

Ref. ^a	PREÇO
3170	12,00

SPRAY MARCADOR - COR NORMAL

SPRAY
MARCADOR

COR NORMAL



CARACTERÍSTICAS

- Tinta em spray para marcação específica de paredes, pavimentos, asfalto, cimento e madeira.
- O produto possui elevada resistência ao desgaste e aos agentes atmosféricos.
- A lata spray pode ser utilizada em todas as posições por dispor de uma válvula especial - "válvula a 360°".



64



Volume		PREÇO
500 ml	12	6,00

Ref. ^a	RAL	DESIGNAÇÃO
2330	1023	Amarelo
2370	3020	Vermelho
2365	5017	Azul

Ref. ^a	RAL	DESIGNAÇÃO
2375	6018	Verde
2380	9005	Preto
2360	9010	Branco

SPRAY MARCADOR - COR FLUORESCENTE

SPRAY
MARCADOR

COR
FLUORESCENTE



CARACTERÍSTICAS

- Tinta à base de pigmentos de elevada luminosidade;
- Proporciona um efeito de alto brilho com elevada capacidade reflectora sobre qualquer superfície;
- Para conseguir os melhores resultados aplicar o produto sobre um fundo branco.
- O produto possui elevada resistência ao desgaste e aos agentes atmosféricos.
- A lata spray pode ser utilizada em todas as posições por dispor de uma válvula especial - "válvula a 360°".



64 FLUO



Volume		PREÇO
500 ml	12	6,00

Ref. ^a	COR	DESIGNAÇÃO
2440		Vermelho fluorescente
2445		Laranja fluorescente
2385		Amarelo fluorescente

Ref. ^a	COR	DESIGNAÇÃO
2395		Verde fluorescente
2390		Fúchsia fluorescente
2435		Azul fluorescente

TECH AEROSOL SPRAYS DE TINTA



SPRAY DE TINTA ESPECIAL PARA SPOILERS E PEÇAS PLÁSTICAS

SPRAY DE TINTA

ESPECIAL PARA SPOILERS E PEÇAS PLÁSTICAS



CARACTERÍSTICAS

- Especialmente indicada para repintar ou renovar pára-choques, spoilers dianteiros, traseiros e laterais. Aplica-se rapidamente e com muita facilidade.
- É um produto idóneo para qualquer tipo de plástico, sem necessidade de tinta base, e seca em poucos minutos.

100 PL

Ref. ^a	COR	DESIGNAÇÃO
3175		Preto Mate
3180		Cinza antracite
3190		Preto Rugoso



Volume		PREÇO		
400 ml	6	5,00		

SPRAY DE TINTA PRIMÁRIO ANTIFERRUGEM

SPRAY DE TINTA

PRIMÁRIO ANTIFERRUGEM



CARACTERÍSTICAS

- Protector de elevado poder de adesão à base de resinas especiais sintéticas e semelhantes, ideal para tratar superfícies mesmo fortemente enferrujadas.
- É muito resistente aos agentes atmosféricos e aos agentes químicos particularmente agressivos.
- Resiste optimamente até uma temperatura de 150 °C em ambiente seco.

100 AR

Ref. ^a	COR	DESIGNAÇÃO
0480		Cinza



Volume		PREÇO		
400 ml	6	5,00		

SPRAY DE TINTA PRIMÁRIO PARA MATERIAIS PLÁSTICOS

SPRAY DE TINTA

FIXADOR PARA MATERIAIS PLÁSTICOS



CARACTERÍSTICAS

- Promove a aderência das peças de automóveis plásticas pintadas, nomeadamente as peças externas dos espelhos, os spoilers, pára-choques e as peças básicas do automóvel, também móveis de plástico para jardim, etc.

100 PR

Ref. ^a	COR	DESIGNAÇÃO
1650		Transparente



Volume		PREÇO		
400 ml	6	6,50		

TECH AEROSOL SPRAYS DE TINTA



SPRAY DE TINTA EFEITO CROMADO

SPRAY DE TINTA
EFEITO CROMADO



CARACTERÍSTICAS

- Spray acrílico de esmalte com aplicações nos mais variados sectores.
- Ideal para os trabalhos de retoque, decoração, e enriquecimento, com acabamentos especiais e exclusivos.

100 CR



Ref. ^a	COR	DESIGNAÇÃO
0465		Cromado
0455		Dourado

Volume		PREÇO
400 ml	6	6,50

SPRAY DE TINTA PARA JANTES DE ALUMÍNIO

SPRAY DE TINTA
EFEITO ALUMÍNIO



CARACTERÍSTICAS

- Tinta acrílica profissional resistente a riscos, álcool e gasolina;
- Ideal para a pintura de rodas e jantes de motos, automóveis de qualquer material: Liga, metal, plástico, etc.
- Para uma melhor aderência usar um primário;
- Pintura adequada para completa renovação ou retoque de jantes em alumínio e discos de aço.



Ref. ^a	COR	DESIGNAÇÃO	Volume		PREÇO
0980		Alumínio	400 ml	6	5,00
0985		Alumínio Brilhante			5,50

SPRAY DE TINTA PARA ALTAS TEMPERATURAS

SPRAY DE TINTA
PARA ALTAS
TEMPERATURAS



CARACTERÍSTICAS

- Tinta especial resistente ao calor, capaz de suportar temperaturas até 600 °C;
- Adequada para uso em automóveis (silenciadores, blocos de motor, escapes) e doméstico (caldeiras, estufas, corta-fogos);
- Equipada com boquilha autolimpante.

100 HT



Ref. ^a	COR	DESIGNAÇÃO
1000		Preto mate
1005		Alumínio

Volume		PREÇO
400 ml	6	6,30

TECH AEROSOL SPRAYS DE TINTA



SPRAY DE TINTA EFEITO FORJA

SPRAY DE TINTA EFEITO FORJA



CARACTERÍSTICAS

- ESMALTE DE FERRO MICACEO • PARA USO INTERNO E EXTERNO
- ÓPTIMO ANTI-FERRUGEM • IDEAL PARA TODAS AS SUPERFÍCIES
- Esmalte anti-ferrugem à base de óxido de ferro micáceo, de elevada cobertura, que dá às superfícies um efeito "areado antigo".
- Forte resistência à corrosão e à acção agressiva dos agentes atmosféricos.
- Adequado para a protecção e o acabamento de grades, balaustres, obras de serralharia, tubos, etc.

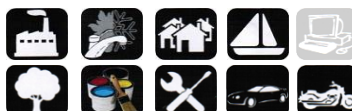

100 FE

Volume	PREÇO
400 ml	6, 5,50

Ref. ^a	COR	DESIGNAÇÃO
1991		Prata
1992		Cinza claro
1993		Cinza forja



Ref. ^a	COR	DESIGNAÇÃO
1994		Cinza antracite
1995		Preto grafite
1996		Ferro antigo

SPRAY DE TINTA COBRE MANCHAS

SPRAY DE TINTA COBRE MANCHAS



CARACTERÍSTICAS

- Tinta especial criada para cobrir diferentes tipos de manchas no interior e exterior;
- Indicada contra manchas de molho de tomate, azeite, vinho, vinagre, chá, café, batom, lápis de cor e de cera e marcadores à base de água;
- Pode ser usada como tinta de acabamento para renovar painéis e tetos falsos em gesso;
- Pode ser pintado com outra tinta depois de 24 horas de espera.



Ref. ^a	COR	DESIGNAÇÃO
3280		Branco

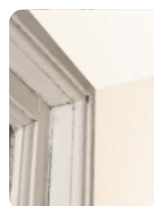

Volume	PREÇO
500 ml	12, 6,00

SPRAY DE ENCHIMENTO (AUTONIVELANTE)

SPRAY DE ENCHIMENTO AUTONIVELANTE



CARACTERÍSTICAS

- Excelente poder de adesão em muitos suportes metálicos, como aço e alumínio;
- Ideal para manutenção de superfícies sujeitas a desgaste ou arranhões;
- Usado para retificar e preencher pequenos defeitos, como furos, sulcos, bolhas, rachaduras e imperfeições em geral;
- Aplicação simples, secagem rápida e fácil de lixar.



Ref. ^a	COR	DESIGNAÇÃO
2790		Branco
2785		Cinza



Volume	PREÇO
400 ml	6, 5,00

TECH AEROSOL MARCADORES MARKER-TECH



Ponta média

MARCADORES MARKER-TECH

ROTULADORES

Marcadores de ponta rígida com tinta à base de acrílico, destina-se à marcação de uma vasta gama de materiais, tais como: vidro, metal, madeira, cerâmica, aço, papelão, borracha, plástico (contentores de plástico, tubos de todos os materiais, peças vazadas, peças de borracha e de metal, produtos de vidro e muitos outros produtos). Fácil de aplicar, de secagem rápida, resistente à água e à abrasão, de longa duração, para uso interior e ao ar livre, removível com acetona. Utilizáveis na indústria, acessórios auto, utensílios domésticos, etc.



Ponta feltro

MARCADORES MARKER-TECH

MADEIRA

Este produto é ideal para reparar arranhões e riscos em qualquer superfície de madeira. Seca rapidamente, resiste à água e à luz solar. A cor é permanente, sobrepintável e imutável ao longo do tempo.



Ponta média

MARCADORES MARKER-TECH

JUNTAS CERÂMICAS

O produto é capaz de renovar facilmente os espaços entre os ladrilhos em cozinhas e casas de banho, removendo todas as heterogeneidades inestéticas. Com as suas substâncias protetoras insolúveis evita fugas e perdas de cor e resiste aos agentes externos.



Ponta média

MARCADORES MARKER-TECH

ELETRODOMÉSTICOS

O produto é capaz de retocar arranhões e golpes em qualquer tipo de superfície vidrada tais como refrigeradores, máquinas de lavar, etc. É resistente à água e protege também contra a possível formação de ferrugem nas superfícies.



Ponta média















MARCADORES MARKER-TECH

RADIADORES













Produto para retoques de radiadores com tinta resistente até 180 °C. Adequado para restaurar a tinta de modo a proteger contra possíveis formações de ferrugem. Realizar os retoques com os radiadores desligados.

MARCADOR	Ref. ^a	COR	DESIGNAÇÃO	Volume		PREÇO
ROTULADORES	010/4610		Branco	10 ml	12	3,00
	010/4635		Preto			
	010/4620		Amarelo			
	010/4640		Vermelho			
	010/4645		Verde			
	010/4615		Azul			
MADEIRA	010/4700		Nogueira claro	10 ml	12	3,30
	010/4705		Nogueira escuro			
	010/4710		Teca			
	010/4715		Cerejeira			
	010/4720		Freixo			
JUNTAS CERÂMICAS	010/4730		Branco	10 ml	6	3,50
ELETRODOMÉSTICOS	010/4740		Branco	10 ml	12	3,50
RADIADORES	010/4745		Branco	10 ml	12	3,50

SPRAYS LUBRIFICANTES

DESIGNAÇÃO	CARATERÍSTICAS	Volume		PREÇO
 <p>0001 SPRAY MULTIFUNCIONAL "SVITA T1" FACTOTUM</p>	<p>Lubrificante multifunções T1, inodoro, com elevada capacidade de penetração, desbloqueante e lubrificante. Elevada capacidade de proteção, podendo ser considerado como anticorrosivo. Elimina a humidade e água dos contactos elétricos. Funciona como anticongelante.</p> 	400 ml	12	6,00
 <p>0340 SPRAY DESBLOQUEADOR ANTIFERRUGEM "SVITA" 48</p>	<p>Limpa, desbloqueia, dissolve ferrugens, lubrifica, protege e repele a água. A sua acção desbloqueadora é causada por uma brusca descida da temperatura quando se aplica o produto. Tem um forte poder penetrante e inibe a coesão entre as superfícies e os depósitos de ferrugem, as gorduras secas ou as partículas metálicas, evitando futuras oxidações.</p> 	400 ml	12	3,70
 <p>1685 SPRAY MULTIFUNCIONAL "SVITA MARINE" 73</p>	<p>Fluido sintético penetrante com alto poder solvente e libertador. Liberta porcas, parafusos, juntas, roscas, molas e outras peças mecânicas da ferrugem e oxidação. Ideal para a manutenção de qualquer peça metálica. Deixa uma película resistente e repelente à água.</p> 	400 ml	12	4,50
 <p>1605 SPRAY DESBLOQUEADOR "ACTIVO MoS₂"</p>	<p>Produto altamente penetrante, chega à profundidade das crostas de óxido, massa seca e às acumulações de poeira metálica. As partículas de bissulfureto de molibdénio penetram nas intersecções resistindo às altas temperaturas e cargas extremas, promovendo a possibilidade de desbloquear e lubrificar. Desbloqueia parafusos e roscas com óxido de ferro, juntas e válvulas.</p> 	400 ml	12	5,50
 <p>0345 SPRAY DE MASSA CONSISTENTE MULTIUSOS 18</p>	<p>É adequado para muitas aplicações como produto multiusos: apresenta um poder adesivo e uma capacidade de formar cordão que garante uma lubrificação duradoura. Penetra a fundo e protege as peças contra o desgaste e a oxidação. Resiste a ambientes salinos e às mudanças de temperatura.</p> 	400 ml	12	5,20
 <p>0295 SPRAY DE MASSA CONSISTENTE NÁUTICA DE LÍTIO</p>	<p>Massa com óxidos de lítio e titânio que a torna interessante para o sector náutico. Ótima ação lubrificante, mesmo na presença de ambientes salinos agressivos. Estável por um longo período de tempo e resistente à oxidação.</p> 	400 ml	12	6,00
 <p>0310 SPRAY DE MASSA COM BISULFURETO DE MOLIBDÉNIO 15</p>	<p>Lubrificante aditivado com bissulfureto de molibdénio para ser utilizado como anti-gripante, anti-bloqueante e lubrificante para pressões extremas e temperaturas elevadas (mantém as suas propriedades inalteradas entre -180 °C e +380 °C).</p> 	400 ml	12	6,00

SPRAYS LUBRIFICANTES

DESIGNAÇÃO	CARACTERÍSTICAS	Volume		PREÇO
 <p style="text-align: center;">0285</p> <p style="text-align: center;">SPRAY DE MASSA DE PTFE</p>	<p>Constituída por fluídos especiais com alto ponto de ebulição. Não deixa resíduos e actua perfeitamente com temperaturas acima de 250°C. Proporciona um baixo coeficiente de atrito, alta inércia química e óptima resistência a cargas elevadas. É utilizada em rolamentos, casquilhos, rolos transportadores, na indústria siderúrgica, do vidro, cerâmica e alvenaria.</p> <p style="text-align: center;">  </p>	400 ml	12	7,00
 <p style="text-align: center;">0300</p> <p style="text-align: center;">SPRAY DE MASSA PARA CORRENTES</p>	<p>Produto ideal para proteger correntes de motociclos, engrenagens abertas e cabos. Penetra e adere às superfícies formando uma barreira protetora e impermeável. Graças à sua capacidade de penetração e de aderência promove uma amortização no contacto entre roscas metálicas.</p> <p style="text-align: center;">Contém solventes: mais fluida / maior penetração</p> <p style="text-align: center;">  </p>	400 ml	12	6,50
 <p style="text-align: center;">0245</p> <p style="text-align: center;">SPRAY DE MASSA PARA CORRENTES "PROFISSIONAL"</p>	<p>Produto desenvolvido para proteger e lubrificar eficazmente as correntes, permitindo elevadas prestações em condições de trabalho extremas. Penetra nos elos das rodas dentadas garantindo um alto rendimento na transmissão do movimento. É particularmente utilizado no setor industrial e no setor desportivo motorizado.</p> <p style="text-align: center;">Sem solventes: muito densa / resistente a altas temperaturas (motos)</p> <p style="text-align: center;">  </p>	400 ml	12	8,00
 <p style="text-align: center;">0190</p> <p style="text-align: center;">SPRAY DE ÓLEO DE SILICONE</p> <p style="text-align: right;">21</p>	<p>Produto multiusos com propriedades anti-aderentes, separadoras e lubrificantes. É usado como desmoldante e separador nas indústrias dos plásticos, das borrachas e da madeira. Apresenta um elevado poder hidrorrepelente e anti-estático. Limpa e protege os plásticos e as borrachas e evita o aparecimento de gretas.</p> <p style="text-align: center;">  </p>	400 ml	12	4,70
 <p style="text-align: center;">0320</p> <p style="text-align: center;">SPRAY DE ÓLEO DE CORTE</p> <p style="text-align: right;">20</p>	<p>É um produto de dupla acção: refrigerante e lubrificante. Útil para furar, cortar, rosca, trabalhar tubos e estampar. Composto por óleos minerais de alta lubricidade. Reduz os desperdícios e prolonga a vida das ferramentas. O produto é totalmente lavável e removível com água.</p> <p style="text-align: center;">  </p>	400 ml	12	4,90
 <p style="text-align: center;">1465</p> <p style="text-align: center;">SPRAY DE ÓLEO PARA ARMAS</p>	<p>Protetor anticorrosivo e lubrificante para armas. Trata-se de um óleo finíssimo com elevadas propriedades de penetração e limpeza. É indispensável para a manutenção de todos os tipos de armas. Forma uma barreira protetora contra a humidade, água e substâncias corrosivas da pólvora.</p> <p style="text-align: center;">  </p>	400 ml	12	7,00

SPRAYS ZINCANTES

DESIGNAÇÃO	CARACTERÍSTICAS	Volume		PREÇO
 <p>0470 SPRAY DE ZINCO 98% FOSCO</p> <p>50</p>	<p>Galvanizante a frio de alto peso molecular do tipo resina sintética. Protege a superfície metálica da oxidação com um revestimento de elevada duração. Forma uma camada uniforme e resistente que pode ser pintada ou usada como acabamento final. Oferece uma excelente resistência às condições atmosféricas. É ideal para o retoque e recuperação de componentes galvanizados.</p> 	400 ml	12	5,00
 <p>0485 SPRAY DE ZINCO CLARO</p>	<p>Galvanizante a frio, ideal para retocar peças zincadas e proteger peças soldadas ou maquinadas. Solidifica quimicamente criando um revestimento duradouro. Resistente às gorduras e aos óleos. Seca rapidamente e pode servir como base para qualquer trabalho de pintura.</p> 	400 ml	12	4,40
 <p>0460 SPRAY DE ZINCO BRILHANTE</p> <p>49</p>	<p>Agente de galvanização a frio à base de resinas sintéticas. Torna a superfície metálica tratada, resistente aos agentes atmosféricos, como a água do mar. Pode ser aplicado como acabamento final, ou pode ser pintado posteriormente. Seca rapidamente e passados 3 a 5 minutos a superfície pode ser trabalhada. É utilizada em grades, portões e em peças que necessitem de um acabamento brilhante.</p> 	400 ml	12	4,70
 <p>2900 SPRAY DE INOX CLARO</p> <p>33</p>	<p>Revestimento protetor à base de aço inox, adequado para todos os metais. Tem uma elevada resistência à água e aos ambientes salinos. Pode ser pintado. Resiste aos agentes atmosféricos e à corrosão.</p> 	400 ml	12	5,40
 <p>2905 SPRAY DE INOX ESCURO COM PARTÍCULAS DE AÇO INOXIDÁVEL</p>	<p>Revestimento protetor à base de resinas alquídicas e silicônicas. Foi concebido para permanecer inalterado ao longo do tempo e ter uma elevada resistência química à corrosão, à ação agressiva dos agentes atmosféricos e uma boa resistência mecânica. Contém partículas puras de aço inoxidável.</p> 	400 ml	12	7,00

SPRAYS DE MANUTENÇÃO

DESIGNAÇÃO	CARACTERÍSTICAS	Volume		PREÇO
 <p>3090</p> <p>SPRAY DESOXIDANTE SECO PARA CONTACTOS ELETRÓNICOS</p> <p>37</p>	<p>Produto formulado para a limpeza de contactos elétricos. Remove rapidamente massas, óleos e resíduos em geral para facilitar o bom funcionamento dos contactos. Possui propriedades hidro-repelentes e facilita a condutibilidade. É inflamável, por isso não deve ser utilizado com o equipamento em funcionamento. Seca em poucos segundos.</p> 	400 ml	12	8,00
 <p>0095</p> <p>SPRAY DECAPANTE</p>	<p>Remove rapidamente todo o tipo de verniz das superfícies metálicas, madeira e outros materiais tais como vidro, polietileno e polipropileno. Prepara a superfície tratada para um novo acabamento, deixando-a limpa, livre de resíduos.</p> 	400 ml	12	7,00
 <p>0385</p> <p>SPRAY DETETOR DE FUGAS DE GÁS</p> <p>47</p>	<p>Produto à base de surfactantes que podem detetar fugas de gás ou ar comprimido em tubagens, válvulas, ligações, cilindros, reservatórios sob pressão, bombas, etc. Não sendo um produto inflamável, permite controlar também condutas de gás inflamável.</p> 	400 ml	12	5,20
 <p>1900</p> <p>PROTETOR ANTI-FERRUGEM</p> <p>CONVERTIDOR DE ÓXIDO</p>	<p>Produto que atua sobre a ferrugem penetrando-a e convertendo-a num composto que adere firmemente ao ferro. Pode ser aplicado em qualquer tipo de ferrugem. É habitualmente utilizado no setor da construção, da agricultura e manutenção de equipamentos em geral. É fácil de aplicar esfregando na área a ser tratada.</p> 	250 ml	12	10,00
		1 l	12	26,00
 <p>0160</p> <p>SPRAY ENCHE E REPARA PNEUS</p> <p>44</p>	<p>Enche e repara instantaneamente qualquer tipo de pneu furado. Não prejudica o pneu nem a câmara de ar, pelo que permite a sua reparação posterior.</p> 	300 ml	12	6,20

SPRAYS ISOLANTES

DESIGNAÇÃO	CARACTERÍSTICAS	Volume		PREÇO
 <p>0975 SPRAY ANTI-ADERENTE PARA SOLDADURA</p> <p>41</p>	<p>Produto à base de polímeros sintéticos que graças às suas propriedades impedem a aderência de escórias e salpicos da soldadura às superfícies tratadas. Adequado para soldadura autogénea, elétrica e com gás inerte. Protege da oxidação e corrosão. Não contém silicone e é não inflamável.</p> 	400 ml	12	4,50
 <p>2810 SPRAY ANTI-ADERENTE COM SILICONE</p>	<p>Desmoldante anti-aderente de elevado rendimento para estampagens e moldagens de materiais termoplásticos, termo-endurecidos e borracha. Hidro-repelente, anti-estático e lubrificante sobre vasta gama de materiais. Eficaz na proteção de componentes plásticos, como casquilhos, aumentando o seu tempo de vida. Ótimo deslizante para o papel, tela e polietileno.</p> 	400 ml	12	5,50
 <p>0195 SPRAY ANTI-ADERENTE SEM SILICONE</p>	<p>Ideal para a estampagem de materiais plásticos e borracha em geral. Os produtos de plástico podem ser submetidos, sem inconvenientes, a operações de pintura, serigrafia, colagem e solda. Contempla boas propriedades para lubrificar e descolar, indicado para o setor da impressão de artigos de papel e cartão. Ajuda o papel a deslizar, não afeta a adesão da borracha nem cria corpos estranhos.</p> 	400 ml	12	5,50
 <p>0175 SPRAY PROTETOR CEROSO PARA MOLDES</p>	<p>Produto ceroso desenvolvido para proteger temporariamente a superfície dos moldes metálicos e de componentes sujeitos a períodos longos de armazenamento ou transporte. Adere facilmente à superfície, inibindo o início de processos corrosivos mesmo em ambientes extremos (ex. transporte por via marítima). Para remover, usar um dissolvente de cera específico.</p> 	400 ml	12	7,00
 <p>0180 SPRAY PROTETOR ANTI-FERRUGEM À BASE DE ÓLEO</p> <p>26</p>	<p>Produto hidro-repelente especialmente indicado para a proteção dos metais durante a armazenagem. Previne a corrosão de superfícies em grosso, acabadas ou cromadas. Isola metais da humidade, dos agentes atmosféricos e das impressões digitais.</p> 	400 ml	12	6,50

SPRAYS DE LIMPEZA

DESIGNAÇÃO	CARACTERÍSTICAS	Volume		PREÇO
 <p>3125 SPRAY DETERGENTE "SUPER CLEANER"</p>	<p>É um detergente eficaz empregado em muitas aplicações industriais. Remove massa, óleo, poeira, cola, tinta, etc. Pode ser utilizado com ótimos resultados em moldes de aço ou materiais similares, para remover a sujidade e para qualquer limpeza durante a manutenção. É inodoro e não é agressivo.</p> 	400 ml	12	4,50
 <p>0105 SPRAY DETERGENTE INDUSTRIAL</p>	<p>Produto de forte poder desengordurante e detergente. A sua formulação especial à base de substâncias naturais, elimina todos os tipos de sujidade. Após a aplicação permanece na superfície até que seja removido. Material adequado para aço inox, mas também para o alumínio.</p> 	400 ml	12	5,00
 <p>2795 SPRAY PARA LIMPEZA E POLIMENTO DE AÇO INOX</p>	<p>Produto à base de solventes, óleos e extratos naturais que permitem obter uma ação detergente, desengordurante e "sanificadora" da superfície do aço. Particularmente apropriado para limpar e lustrear aço, de qualquer tipo de superfície não absorvente, sobre a qual se pretenda deixar um acabamento polido e brilhante.</p> 	400 ml	12	6,00
 <p>0065 SPRAY SOLVENTE PARA ESPUMA DE POLIURETANO</p>	<p>Produto específico para remover e dissolver instantaneamente os resíduos de espuma de poliuretano não endurecida dos equipamentos utilizados para a aplicar, assim como do vestuário e demais materiais.</p> 	500 ml	12	4,50
 <p>0140 SPRAY REMOVE COLA E ETIQUETAS</p>	<p>Solução à base de solventes e polímeros que possui elevada rapidez de ação na dissolução de colas sintéticas de vários tipos. Pulverizando na vertical não escorre. Descola a etiqueta ou a parte colada em poucos minutos.</p> 	200 ml	12	5,00

SPRAYS DE LIMPEZA

DESIGNAÇÃO	CARATERÍSTICAS	Volume		PREÇO
 <p>0090</p> <p>SPRAY REMOVEDOR DE SILICONE</p> <p>74</p>	<p>Mistura de solventes própria para remover o excesso e restos de silicone. O produto atua mais rapidamente na presença de silicone fresco, sendo mais lenta a ação em silicone seco. Se houver muito silicone é melhor remover o máximo possível e depois aplicar o produto. Não é agressivo a qualquer superfície nem se torna opaco.</p> 	400 ml	12	6,00
 <p>1725</p> <p>DESENTUPIDOR DE CANOS</p>	<p>Produto extra concentrado adequado para resolver qualquer forma de entupimento. É particularmente ativo para resíduos orgânicos, nomeadamente: papel, algodão, substâncias alimentares, crostas de detergente, etc. Liberta tubos entupidos por depósitos inertes e orgânicos em geral.</p> 	1 l	12	6,20
 <p>3130</p> <p>SPRAY HIGIENIZANTE PARA SISTEMAS DE AR CONDICIONADO</p> <p>16</p>	<p>Produto desenvolvido para uma ação rápida e eficaz de limpeza de instalações de ar condicionado. Elimina fungos, bolores, bactérias e microrganismos dos sistemas de ar condicionado. Atraza a formação de acumulações bacterianas, humidade e libertação de maus odores.</p> 	400 ml	12	4,50
 <p>0110</p> <p>SPRAY AR COMPRIMIDO "AIR DUSTER"</p>	<p>Elimina imediatamente a poeira depositada em superfícies menos acessíveis. O Air Clean é indicado para limpar lentes, objectivas, computadores, relojoaria e mecânica em geral.</p> 	400 ml	12	4,50
 <p>0075</p> <p>SPRAY DE LIMPEZA PARA TRAVÕES E EMBRAIAGENS</p> <p>39</p>	<p>Produto desenvolvido para a limpeza de travões de disco, de tambor e embraiagens. Adequado para pastilhas, pinças, patins, cilindros, molas, etc. Seca rapidamente sem deixar resíduos.</p> 	500 ml	12	4,50

MASSA LAVA-MÃOS AMARELA

Com abrasivo vegetal



MASSA LAVA-MÃOS AMARELA é uma pasta lava-mãos concebida especialmente para remover todo tipo de sujidade intensa nos setores industrial, automóvel e de bricolage. Contém sabão e tensoativos de origem natural vegetal provenientes de fontes renováveis, abrasivos naturais e microgranulados inertes para uma limpeza eficaz das mãos. O produto deixa as mãos macias e agradavelmente perfumadas. Compatibilidade cutânea dermatologicamente testada.

Modo de utilização: aplicar o produto nas mãos secas, friccionar, adicionando gradualmente água até remover a sujidade. Enxaguar bem e secar.

Advertências: não utilizar o produto em partes delicadas (rosto, axilas, partes íntimas). Manter fora do alcance das crianças. Evitar o contacto com os olhos.



Peso		PREÇO
1 kg	12	3,30
4 kg	4	10,00

MASSA LAVA-MÃOS BRANCA - PLUS

Com abrasivo mineral



Sujidade entranhada



Aplicar sobre as mãos secas

MASSA LAVA-MÃOS BRANCA - PLUS é uma massa lava mãos fabricada com derivados vegetais. Elimina rápida e profundamente silicones, vernizes, massa, esmaltes e mesmo poliuretanos. É igualmente excelente para a eliminação de gorduras graças a uma “equipa” de agentes abrasivos inertes e detergentes de base vegetal. O produto deixa as mãos macias e agradavelmente perfumadas.

Modo de utilização: aplicar o produto nas mãos secas, friccionar, adicionando gradualmente água até remover a sujidade. Enxaguar bem e secar.

Advertências: não utilizar o produto em partes delicadas (rosto, axilas, partes íntimas). Manter fora do alcance das crianças. Evitar o contacto com os olhos.



Peso		PREÇO
1 kg	12	5,30
4 kg	4	18,00

TECH AEROSOL COLAS



Refª 0695 - Cola permanente multiusos

COLA PERMANENTE MULTIUSOS



- Particularmente indicado para a ligação de borracha, metal, vinil, tecido, madeira e materiais plásticos;
- Resistência ao calor, mesmo com a exposição prolongada;
- Também resistente aos plastificantes em geral.



Volume		PREÇO
400 ml	12	5,50

Refª 0675 - Flash 100 - Cola de cianoacrilato

COLA DE CIANOACRILATO "FLASH 100"



- Cola universal de cianoacrilato para uso geral adequado a vários materiais;
- Cor transparente no ponto de aplicação;
- Apresenta alta fluidez e ajuste rápido.

Secagem rápida
±10 segundos

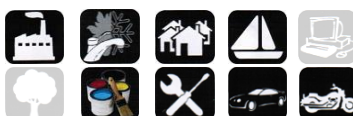

Peso		PREÇO
10 g	24	3,60
20 g	12	4,60

Refª 0680 - Flash 200 - Cola de cianoacrilato

COLA DE CIANOACRILATO "FLASH 200"



- Cola universal de cianoacrilato para uso geral adequado a vários materiais;
- Cor transparente no ponto de aplicação;
- Apresenta uma viscosidade média-alta, para aplicações em posição inclinada;
- Secagem mais lenta para proporcionar a possibilidade de posicionamento dos componentes a colar.

Permite reposicionamento
±20 segundos

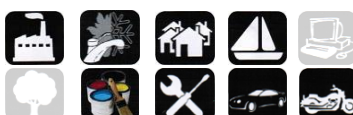

Peso		PREÇO
10 g	24	3,60
20 g	12	4,60

STICKS DE COLA TERMOFUSÍVEL



10 x 1 kg

Para trabalhos de montagem, colagem e reparação em madeira, plástico, cartão, papel, tecido, estofos, materiais pré-aquecidos, borracha, couro, cerâmica...

Produto Europeu conforme o regulamento REACH (CE) n.º 1907/2006



COR	Ø x L	Temperatura de trabalho	Tempo de pressão	Temperatura de fusão	Viscosidade média	Aplicações
Transparente	12x200 mm	180~200 °C	20~25 s	75 °C	11500 cps 180 °C	Madeira e derivados, cartão, plástico, cerâmica, couro, tecido, joalharia e artesanato.

Código	Artigo	Descrição			€/Kg
1195234	H 12/200 Transparente	Sticks de cola termofusível em saquetas de 1 Kg	10 Kg	1 Kg	15,00

PISTOLAS PARA COLA TERMOFUSÍVEL



Ro-ma **GRIP 15HL**

40 Watts
BRICOLAGE

220-240 V
~ 50 Hz **40 Watts**

Extrusão máx.: 530 g/h • Ponteira isolada, anti-gotas, removível e permutável



Ro-ma **GRIP 18HP**

60 Watts
BRICOLAGE

220-240 V
~ 50 Hz **60 Watts**

Extrusão máx.: 600 g/h • Ponteira isolada, anti-gotas, removível e permutável



Ro-ma **GRIP 20XP**

80 Watts
BRICOLAGE

220-240 V
~ 50 Hz
80 Watts
CLASSE I

Extrusão máx.: 1 Kg/h • Ponteira isolada, anti-gotas, removível e permutável • Termostato de segurança



Ro-ma **M 195**
ELECTRIC

120 Watts
PROFISSIONAL INDUSTRIAL

220-240 V
~ 50 Hz **120 Watts**

Extrusão máx.: 800 g/h • Temperatura 190°C • Ponteira isolada, anti-gotas, removível e permutável • Isol. classe 2 • Apoio removível

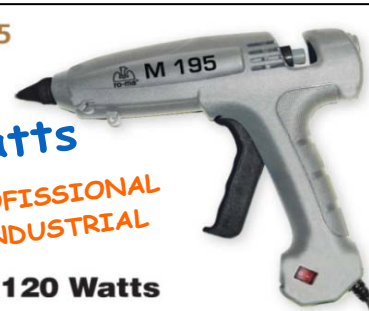

Código	Artigo	Descrição		€/Unidade
0195136	RO-MA GRIP 15HL	Pistola para cola termofusível - 40 Watts	0,300 Kg	16,00
0195137	RO-MA GRIP 18HP	Pistola para cola termofusível - 60 Watts	0,310 Kg	18,00
0195138	RO-MA GRIP 20XP	Pistola para cola termofusível - 80 Watts	0,500 Kg	70,00
0195217	RO-MA M195	Pistola para cola termofusível - 120 Watts	0,470 Kg	125,00

Edição: 1/2006
Data: Setembro 2006

Revisão: 5
Data: 26 de fevereiro 2024

Preço: €/Unidade

TABELA 08.20

CORRENTE SOLDADA ZINCADA COMERCIAL



• AÇO ZINCADO

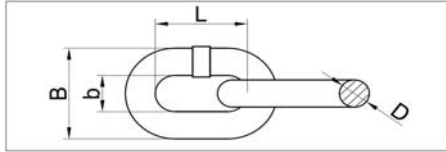

EMBALAGEM:
BIDÃO SELADO DE 50 Kg

CARACTERÍSTICAS:

A corrente soldada comercial é produzida a partir de aço com baixo teor em carbono e está disponível em vários tamanhos de elos.

É adequada para uma vasta gama de aplicações nas indústrias da manufatura, náutica e agricultura.

A corrente soldada comercial é fornecida não testada e não marcada para soluções mais económicas numa grande variedade de aplicações genéricas.

Material: Aço com baixo teor em carbono

Acabamento: Zincado

ATENÇÃO: NÃO EXCEDER A CARGA MÁXIMA DE TRABALHO.

NÃO ADEQUADA PARA LEVANTAMENTO DE CARGAS.

DIÂMETRO D		D [mm]	L [mm]	B [mm]	b [mm]	PESO [Kg/m]	COMPRIMENTO [m/50 Kg]	CARGA ROTURA [Kg]	PREÇO € / Kg
Nominal	["]								
3	1/8	3,17	20,0	11,6	5,2	0,16	312,5	270	4,00
4	5/32	3,97	24,2	15,4	7,1	0,23	217,4	360	3,80
5	3/16	4,76	25,8	17,7	8,1	0,42	119,0	600	3,50
6	1/4	6,35	27,6	23,3	10,6	0,78	64,1	870	3,40
8	5/16	7,94	32,1	28,6	12,6	1,24	40,3	1 300	3,20
10	3/8	9,53	35,4	33,6	14,5	1,80	27,8	2 200	3,20
12	1/2	12,70	50,4	44,2	19,0	3,20	15,6	3 600	3,20
16	5/8	15,87	60,8	54,9	23,8	5,10	9,8	6 800	3,40
19	3/4	19,05	76,4	66,5	27,0	7,00	7,1	9 000	3,70

CORRENTE SOLDADA DIN 766 AÇO INOX AISI 316 (A4)



• AÇO INOX AISI 316 (A4)

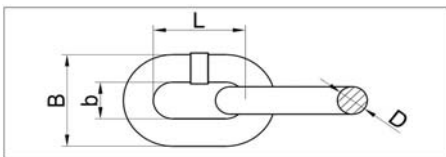

ELOS MARCADOS "316"
CADA 50 cm

CARACTERÍSTICAS:

Vulgarmente usada em aplicações náuticas e industriais, muito usada em indústrias químicas, processamento de alimentos e em ambientes extremos.

Adequada para guinchos.

Material: Aço inoxidável AISI 316 (INOX A4).

Calibrada e testada com carga de prova..

Fator de design 4:1

Acabamento polido.

ATENÇÃO: NÃO EXCEDER A CARGA MÁXIMA DE TRABALHO.

NÃO ADEQUADA PARA LEVANTAMENTO DE CARGAS.

DIÂMETRO D [mm]	L [mm]	B [mm]	PESO [Kg/m]	CARGA DE TRABALHO [Kg/m]	CARGA DE PROVA [Kg]	CARGA DE ROTURA [Kg]	EMBALAGEM QUANT. MÍNIMA DE ENCOMENDA [m]	PREÇO € / metro
3	16,0	12,0	0,165	70	200	280	200	3,45
4	16,0	13,6	0,32	200	500	800	100	5,99
5	18,5	17,0	0,50	320	800	1 250	50	9,05
6	18,5	20,0	0,80	400	1 000	1 600	50	13,66
8	24,0	27,0	1,40	800	2 000	3 200	25	23,36
10	28,0	34,0	2,20	1 250	3 200	5 000	20	40,85

**CORRENTE SOLDADA
AÇO DE ALTA RESISTÊNCIA
-GRADE 80-**



• AÇO DE ALTA RESISTÊNCIA - GRADE 80

• DE ACORDO COM A NORMA EUROPEIA EN 818-2 GRADE 8

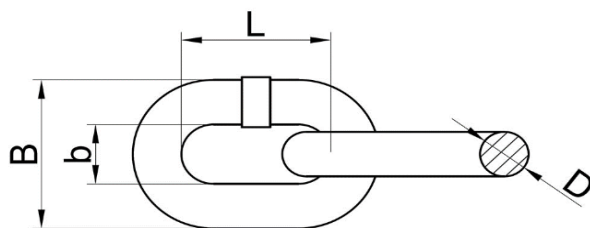

CARATERÍSTICAS:

- Corrente de elos curtos para levantamento de cargas;
- Em conformidade com a Norma Europeia **EN818-2**;
- Produzida em aço ligado da melhor qualidade;
- Marcada "RG80A" e código de rastreabilidade;
- Temperada e revenida;
- Testada com carga de prova;
- De acordo com o fator de design 4:1 requerido pela Norma **EN818-2**;
- Revestimento eletroforético negro;

CE
EN 818-2 GRADE 8



MARCAÇÃO:
RG80A
+
CÓDIGO DE
RASTREABILIDADE

DIÂMETRO D [mm]	L [mm]	B [mm]	b [mm]	PESO [Kg/m]	CARGA MÁX. DE TRABALHO [Kg]	CARGA PROVA MÍN. [Kg]	CARGA ROTURA MÍN. [Kg]	DEFLEXÃO MÍNIMA [mm]	EMBALAGEM QUANT. MÍNIMA DE ENCOMENDA [m]	PREÇO € / metro
6	18,0	21,0	9,0	0,802	1 100	2 830	4 520	4,8	50	5,04
7	21,0	24,0	10,0	1,083	1 500	3 850	6 160	5,6	50	6,30
8	24,0	27,5	11,5	1,416	2 000	5 030	8 040	6,4	25	8,19
10	30,0	34,5	14,5	2,216	3 200	7 850	12 600	8,0	20	12,60
13	39,0	45,0	19,0	3,749	5 300	13 300	21 200	10,0	10	19,22
				NOVA EMBALAGEM: tambor metálico com ≈ 500 kg				150	18,38	
16	49,0	55,5	23,5	5,571	8 000	20 100	32 200	13,0	10	30,14
				NOVA EMBALAGEM: tambor metálico com ≈ 500 kg				100	28,35	
18	54,0	61,0	25,0	7,154	10 000	25 400	40 700	14,0	10	42,53
				NOVA EMBALAGEM: tambor metálico com ≈ 500 kg				70	39,90	
19	57,0	64,0	26,0	7,773	11 200	28 400	45 400	15,0	10	42,53
				NOVA EMBALAGEM: tambor metálico com ≈ 500 kg				70	39,90	
20	60,0	68,0	28,0	8,641	12 500	31 400	50 300	16,0	60	47,25
				NOVA EMBALAGEM: tambor metálico com ≈ 500 kg						

CABO DE AÇO INOX AISI 316 (A4)

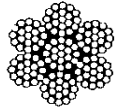

• **AÇO INOX AISI 316 (A4)**

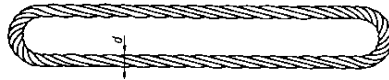

EMBALAGEM: BOBINES DE 50 E 100 METROS

MEDIDA (d) [mm]	CONSTRUÇÃO	CARGA DE ROTURA [Kg]	MATERIAL	PREÇO			
				BOBINE 100 mt		BOBINE 50 mt	
				/BOBINE	/METRO	/BOBINE	/METRO
2	7x19	215	INOX AISI 316 (A4)	84,67	0,85	44,35	0,89
3	7x19	478	INOX AISI 316 (A4)	132,30	1,32	66,53	1,33
4	7x19	850	INOX AISI 316 (A4)	211,68	2,12	106,44	2,13
5	7x19	1325	INOX AISI 316 (A4)	289,80	2,90	146,36	2,93
6	7x19	1910	INOX AISI 316 (A4)	395,64	3,96	199,58	3,99
8	7x19	3395	INOX AISI 316 (A4)	711,90	7,12	359,25	7,19
10	7x19	4180	INOX AISI 316 (A4)	975,24	9,75	492,31	9,85
12	7x19	7500	INOX AISI 316 (A4)	1 388,52	13,89	701,57	14,03

CABO EM AÇO GALVANIZADO - COM ALMA - DIN 3055

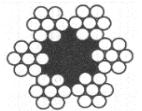

• **AÇO GALVANIZADO (1770 N/mm²)**

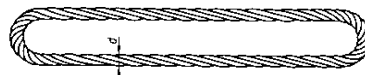



MATERIAL DA ALMA:
FIBRAS SINTÉTICAS

MEDIDA (d) [mm]	CONSTRUÇÃO	CARGA DE ROTURA [Kg]	MATERIAL	EMBALAGEM: BOBINE	PREÇO	
					/BOBINE	/METRO
2	6x7+FC	266	AÇO GALVANIZADO	250 m	63,54	0,25
2,5	6x7+FC	398	AÇO GALVANIZADO	250 m	85,04	0,34
3	6x7+FC	598	AÇO GALVANIZADO	250 m	96,77	0,39
4	6x7+FC	1060	AÇO GALVANIZADO	150 m	77,22	0,51
5	6x7+FC	1661	AÇO GALVANIZADO	100 m	70,38	0,70
6	6x7+FC	2391	AÇO GALVANIZADO	100 m	107,53	1,08

CERRA CABOS DIN 741



- AÇO ZINCADO COMERCIAL
- AÇO INOX AISI 316 (A4)

MEDIDA INGLESA ["]	Ø CABO [mm]	MATERIAL	INOX-A4		ZINCADO COMERCIAL	
				PREÇO		PREÇO
"1/8	D-3	INOX-A4 ; ZINCADO	100	98,46	200	12,72
"5/32	D-4	INOX-A4	100	101,54		
"3/16	D-5	INOX-A4 ; ZINCADO	100	113,85	100	15,27
"1/4	D-6	INOX-A4 ; ZINCADO	50	135,48	100	18,38
"5/16	D-8	INOX-A4 ; ZINCADO	25	160,77	50	30,53
"3/8	D-10	INOX-A4 ; ZINCADO	25	257,69	25	46,08
"7/16	D-11	ZINCADO			25	77,63
"1/2	D-13	INOX-A4 ; ZINCADO	10	579,23	25	85,38
"5/8	D-16	INOX-A4 ; ZINCADO	10	973,92	10	133,44
"3/4	D-19	ZINCADO				179,55
"7/8	D-22	ZINCADO				286,55
1"	D-26	ZINCADO				316,97
	D-30	ZINCADO				472,00

CERRA CABOS PLANO FORMA OVAL - ZINCADO



- AÇO C15 ZINCADO

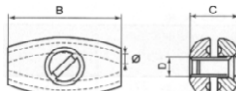

TAMANHO (Ø)	A [mm]	B [mm]	C [mm]	D [mm]		PREÇO
2		28	11	M5	100	43,20
3		28	12	M5	100	48,60

CERRA CABOS PLANO SIMPLES - ZINCADO

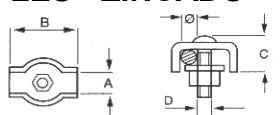

- AÇO C15 ZINCADO

TAMANHO (Ø)	A [mm]	B [mm]	C [mm]	D [mm]		PREÇO
2	4	18,5	5	M4	100	11,88
3	6	20	6	M4	100	15,44
4	8	22,5	7	M5	100	19,01
5	10	26	8	M6	100	29,70
6	12	30	10	M6	100	41,58

CERRA CABOS PLANO DUPLO - ZINCADO

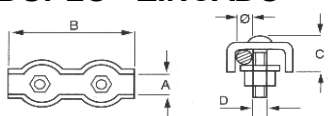

- AÇO C15 ZINCADO

TAMANHO (Ø)	A [mm]	B [mm]	C [mm]	D [mm]		PREÇO
3	6	40	6	M4	100	27,32
4	8	45	7	M5	50	35,64
5	10	52	8	M6	50	59,40
6	12	60	10	M6	50	83,16

ESTICADORES GANCHO-OLHAL DIN 1480



• AÇO ZINCADO COMERCIAL • AÇO INOX AISI 316 (A4)

MEDIDA INGLESA ["]	MEDIDA [mm]	COMPRIM. [mm]	MATERIAL	INOX-A4		ZINCADO COMERCIAL	
					PREÇO		PREÇO
"3/16	M-5	70	INOX-A4 ; ZINCADO	50	307,17	25	83,94
"1/4	M-6	100	INOX-A4 ; ZINCADO	50	447,44	50	87,13
"5/16	M-8	110	INOX-A4 ; ZINCADO	25	698,91	25	129,63
"3/8	M-10	125	INOX-A4 ; ZINCADO	10	1 261,02	25	197,63
"1/2	M-12	125	INOX-A4 ; ZINCADO	5	2 245,23	10	284,75
"5/8	M-16	190	INOX-A4 ; ZINCADO	5	4 232,25	5	680,00
"3/4	M-20	220	ZINCADO				1 264,38
"7/8	M-22	240	ZINCADO				2 018,75
1"	M-24	260	ZINCADO				2 931,44
	M-30		ZINCADO				5 950,00

MANILHAS DIREITAS DIN 82101-A

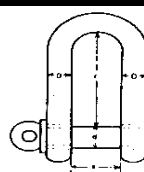

• AÇO ZINCADO • AÇO INOX AISI 316 (A4)

MEDIDA (d) [mm]	a [mm]	c [mm]	INOX-A4		ZINCADO	
				PREÇO		PREÇO
4	9	18	100	123,03	100	28,35
5	11	22	100	130,36	100	29,37
6	13	26	50	175,28	50	31,39
8	16	32	50	310,56	50	50,52
10	19	38	25	538,31	25	81,45
12	26	52	10	1 119,83	5	131,18
14	29	58			5	183,38
16	32	64	5	2 432,83	5	263,25
20	38	70	5	4 001,41	5	495,00
22	44	74			5	708,75
25	48	80			5	1 035,00
28	56	96			5	1 462,50
32	64	114			5	2 587,50

MOSQUETÃO

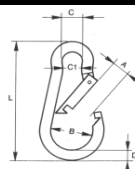

• AÇO ZINCADO COMERCIAL • AÇO INOX AISI 316 (A4)

D [mm]	L [mm]	C [mm]	C1 [mm]	PESO [g]	INOX-A4		ZINCADO	
						PREÇO		PREÇO
4	40	7	4	12	100	150,18	100	29,02
5	50	7	5	19	100	170,28	100	30,54
6	60	8	6	27	50	226,68	100	37,32
8	80	12	9	65	25	369,08	50	58,97
10	100	15	11	127	10	645,59	25	97,93
12	140	20	13	260	10	1 436,73	10	198,90

MOSQUETÃO DE SEGURANÇA ROSCADO

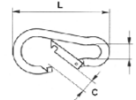

• AÇO ZINCADO COMERCIAL • AÇO INOX AISI 316 (A4)

D [mm]	L [mm]	C [mm]	D [mm]	PESO [g]	INOX-A4		ZINCADO	
						PREÇO		PREÇO
6	60	8	9	27			100	65,52
8	80	9	12	65			50	90,09
10	100	11	15	127			25	160,29
12	140	19	20	260			10	301,86

ELOS DE LIGAÇÃO

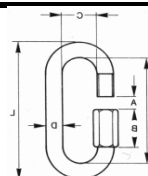

• AÇO ZINCADO COMERCIAL • AÇO INOX AISI 316 (A4)

D [mm]	C [mm]	A [mm]	E [mm]	PESO [g]	INOX-A4	ZINCADO
M-3,5	10	5	25	9	276,00	35,29
M-4	11,5	5,5	31,5	11	303,60	41,59
M-5	13	6,5	38,5	20	345,00	49,33
M-6	14,5	7,5	45	34	372,60	54,04
M-8	17,5	10	58	78	524,40	97,29
M-10	20,5	12	60	135	897,00	187,18
M-12	25	15	80,5	230	1 656,00	295,15

ELOS DE REPARAÇÃO "DE PANCADA"

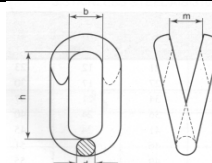

• AÇO ZINCADO

D [mm]	b [mm]	h [mm]	m [mm]	PESO [g]	INOX-A4	ZINCADO
4	8	20	5,5	11		12,38
5	9,5	23	6	20		16,88
6	10,5	29	7	34		28,13
8	15	37	9	78		47,25
10	17	37,5	9	135		78,75

SAPATILHO PASSA-CABOS

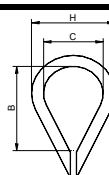

• AÇO ZINCADO • AÇO INOX-A4

Ø CABO [mm]	B [mm]	C [mm]	H [mm]	PESO [g]	INOX-A4	ZINCADO
3	16	9	16	2,3	28,68	13,50
4	19	11	18	3	34,42	13,50
5	24	14	22	5	40,16	16,20
6	28	17	26	8	80,30	16,20
8	33	19	30	15	86,04	21,60
10	38	21	34	23		36,00
12	44	30	46	44		47,70
16	57	40	59	83		108,00
20	78	51	77	215		162,00

OLHAL DE CARGA MACHO - DIN 580 FÊMEA - DIN 582



DIN 580

DIN 582

• AÇO ZINCADO • AÇO INOX-A4

Ø ROSCA	DIÂMETRO INTERIOR [mm]	ALTURA [mm]	CARGA DE TRABALHO [Kg] (APLICÁVEL AO AÇO ZINCADO)		INOX-A4		ZINCADO	
			1	2				
M-6	14	27	75	50	292,00	292,00	59,08	59,08
M-8	20	36	140	95	292,00	292,00	59,08	59,08
M-10	25	45	230	170	478,30	478,30	94,15	94,15
M-12	30	53	340	240	799,40	799,40	133,12	133,12
M-16	35	62	700	500	1 383,58	1 383,58	219,45	219,45
M-20	40	71	1200	830	1 897,03	1 897,03	309,61	309,61
M-24	50	90	1800	1270			637,43	637,43
M-30	60	109	3600	2600			1 492,95	1 492,95
M-36	70	128	5100	3700			2 483,04	2 483,04

Edição: 1/2006
Data: Setembro 2006

Revisão: 9
Data: 6 de novembro 2023

Preço: €100

TABELA 9.5

GANCHOS DE CARGA COM PATILHA DE SEGURANÇA



• AÇO GALVANIZADO

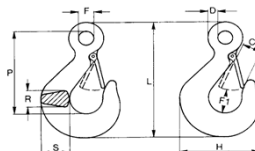

CARGA DE TRABALHO WLL [Kg]	TAMANHO C [mm]	F [mm]	F1 [mm]	H [mm]	L [mm]	PREÇO
250	15	12	16	53	88	324,00
500	17	13	21	73	117	492,00
1000	25	19	27	95	157	864,00
1600	31	24	40	118	193	1 380,00
2500	42	28	40	148	243	2 640,00

GANCHOS DE CARGA - TIPO AMERICANO COM PATILHA DE SEGURANÇA



• AÇO DE ALTA RESISTÊNCIA

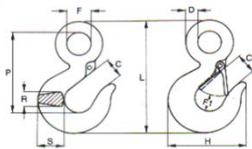

CARGA DE TRABALHO WLL [Kg]	TAMANHO C [mm]	F [mm]	F1 [mm]	H [mm]	P [mm]	PREÇO
3000	31	31,8	30	100	119,1	2 760,00
4500	38	39,7	40	120	146,1	4 920,00
7000	47,8	50,8	47	150	187,5	10 200,00

GANCHOS DE CARGA GIRATÓRIOS COM PATILHA DE SEGURANÇA



• AÇO DE ALTA RESISTÊNCIA

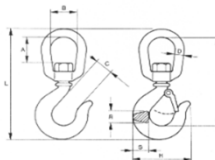

CARGA DE TRABALHO WLL [Kg]	TAMANHO C [mm]	A [mm]	B [mm]	H [mm]	P [mm]	PREÇO
1000	23	25	25	75	130	1 200,00
2000	28	30	45	100	170	3 000,00
3200	32	35	45	120	185	4 200,00
4000	33	40	45	120	215	5 040,00
6300	44	47	60	160	260	7 680,00
10000	57	55	80	200	310	12 720,00

MOITÃO 1 RODA



- ZAMAK
- RODA EM NYLON

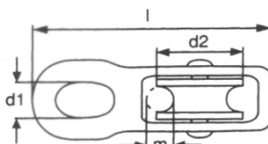

Ø (d2)	m [mm]	d1 [mm]	L [mm]	Peso [g]	PREÇO
15	5	10	50	25	100,00
20	6	11	60	40	110,00
25	7	12	70	60	160,00
30	8	13	80	75	205,00
40	9	14	93	125	340,00
50	12	16	115	190	550,00

MOITÃO 2 RODAS



- ZAMAK
- RODAS EM NYLON

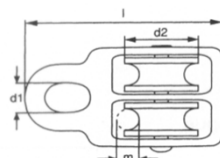

Ø (d2)	m [mm]	d1 [mm]	L [mm]	Peso [g]	PREÇO
15	5	10	50	40	150,00
20	6	11	60	60	170,00
25	7	12	70	90	250,00
30	8	13	80	140	390,00
40	9	14	93	260	540,00
50	12	16	117	420	800,00

MOITÃO 1 RODA DESTORCEDOR



- ZAMAK

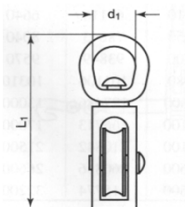

Tamanho ["]	d1 [mm]	L1 [mm]			PREÇO
3/4	19	60			140,00
1"	20	73			200,00
1" 1/2	21	88			370,00
2"	21	105			590,00

ESTICADOR NÁUTICO



• AÇO INOX AISI 316 (A4)

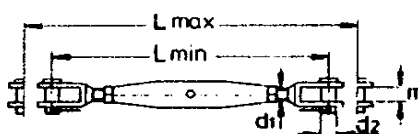

Ø (d1)	m [mm]	L máx. [mm]	L mín. [mm]		PREÇO
M-5	10	189	127		897,84
M-6	10	190	145		1.246,99
M-8	10	265	179		1.745,79
M-10	12	310	235		2.244,59

ESTICADOR BRANDAL NÁUTICO



• AÇO INOX-A4

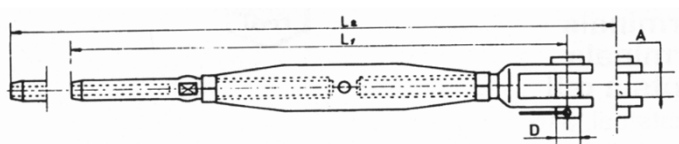

ROSCA	Ø CABO [mm]	L1 [mm]	L2 [mm]	A [mm]	D [mm]	PESO [g]	PREÇO
M-5	2 / 2,5	130	205	6	5,2	60	800,00
M-6	3	170	240	7,5	6	90	997,60
M-8	4	200	280	11	8	140	1.496,39
M-10	5	225	310	12	9	240	1.995,19

TERMINAL BRANDAL



• AÇO INOX-A4

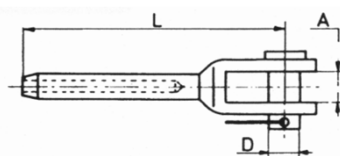

Ø CABO [mm]	D [mm]	A [mm]	L [mm]	PESO [g]	PREÇO
3	5	7,5	65	28	349,16
4	6	10	77	51	498,80
5	8	12	88	77	748,20
6	9	14	106	179	997,60
8	14,5	16	145	250	1.640,00
10	16,5	17	150	350	2.120,00

TERMINAL ROSCADO



• AÇO INOX-A4

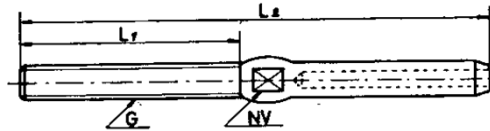

Ø CABO [mm]	ROSCA	L2 [mm]			INOX-A4
2,5	M-5	75			199,52
3	M-6	80			249,40
4	M-8	106			349,16
5	M-10	114			498,80
6	M-12	130			1 172,18
8	M-16	158			1 845,55

TERMINAL COM OLHAL



• AÇO INOX-A4

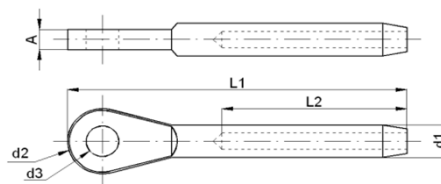

Ø CABO [mm]	d1 [mm]	d2 [mm]	d3 [mm]	L1 [mm]	L2 [mm]	A [mm]	INOX-A4
3	6	13	6,5	64	36	4	299,28
4	7	18	8,5	74	39	6	349,16
5	10	22	10	91	50	7	548,68
6	13	28	12,5	108	62	8	997,60
8	16	32	15	140	85	10	1 300,00
10	18	36	16,4	160	90	12	1 600,00

DESTORCEDOR OLHAL-OLHAL



• AÇO ZINCADO
• AÇO INOX-A4

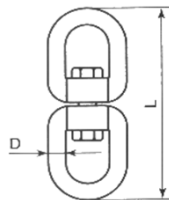

Ø ROSCA	D [mm]	L [mm]	FORÇA MÁXIMA DE TRABALHO [kg]	INOX-A4	ZINCADO
M-5	5	59	115	648,44	
M-6	6	65	140	748,20	210,00
M-8	8	90	250	997,60	308,00
M-10	10	115	300	1 496,39	420,00
M-13	13	154	650		770,00
M-16	16	188	1000		1 050,00
M-19	19	229	1600		1 820,00

ELÉTRODOS



HYUNDAI
WELDING

AÇO AO CARBONO - AWS E6013

REVESTIMENTO:
RUTILO

HYUNDAI WELDING	Ø x COMPRIM. [mm]	QUANTIDADE POR CAIXA		PREÇO	
		PEQUENA	GRANDE	€/ Kg	€/ 10 Unid
S-6013-LF	2,60 x 350	5 kg / 245 Unid.	20 kg / 980 Unid.	5,34	1,09
	3,20 x 350	5 kg / 165 Unid.	20 kg / 660 Unid.	4,98	1,51
	4,00 x 400	5 kg / 105 Unid.	20 kg / 420 Unid.	4,77	2,27

AÇO INOXIDÁVEL AISI 304; 308 - AWS E308L-16

HYUNDAI WELDING	Ø x COMPRIM. [mm]	QUANTIDADE POR CAIXA		PREÇO €/ Kg
		PEQUENA	GRANDE	
S-308-L	2,60 x 300	2,5 kg / 137 Unid.	10 kg / 548 Unid.	26,40
	3,20 x 350	2,5 kg / 77 Unid.	10 kg / 308 Unid.	26,40

AÇO INOXIDÁVEL AISI 316 - AWS E316L-16

HYUNDAI WELDING	Ø x COMPRIM. [mm]	QUANTIDADE POR CAIXA		PREÇO €/ Kg
		PEQUENA	GRANDE	
S-316-L	2,60 x 300	2,5 kg / 137 Unid.	10 kg / 548 Unid.	34,80
	3,20 x 350	2,5 kg / 77 Unid.	10 kg / 308 Unid.	34,80

ELÉCTRODOS BÁSICOS - AWS E7018-1



HYUNDAI WELDING	Ø x COMPRIM. [mm]	QUANTIDADE POR CAIXA		PREÇO	
		PEQUENA	GRANDE	€/ Kg	€/ 10 Unid
S-7018.G	2,60 x 350	5 kg / 220 Unid.	20 kg / 880 Unid.	6,42	1,46
	3,20 x 350	5 kg / 145 Unid.	20 kg / 580 Unid.	6,00	2,07

ELÉCTRODOS



HYUNDAI
WELDING

FERRO FUNDIDO - AWS E Ni-CI

HYUNDAI WELDING	Ø x COMPRIM. [mm]	QUANTIDADE POR CAIXA [Kg]		PREÇO €/Kg
		 PEQUENA	 GRANDE	
S-NCI	2,60 x 300	2,5 kg	10 kg	70,00
	3,20 x 350	2,5 kg	10 kg	68,00

VARETA PARA SOLDADURA TIG

HYUNDAI
WELDING

• AÇO INOX-A2 • AÇO INOX-A4



AWS ER 308LSi

AÇO INOXIDÁVEL AISI 304 ; 308

HYUNDAI WELDING	Ø x COMPRIM. [mm]	QUANTIDADE POR CAIXA	PESO POR CAIXA [Kg]	N.º DE CAIXAS POR PACOTE	QUANTIDADE POR PACOTE	PREÇO
						€/Kg
ST-308 LSI	1,2 x 1000		5			15,80
	1,6 x 1000		5			13,50
	2,0 x 1000		5			13,00
	2,4 x 1000		5			12,80

AWS ER 316LSi

AÇO INOXIDÁVEL AISI 316

HYUNDAI WELDING	Ø x COMPRIM. [mm]	QUANTIDADE POR CAIXA	PESO POR CAIXA [Kg]	N.º DE CAIXAS POR PACOTE	QUANTIDADE POR PACOTE	PREÇO
						€/Kg
ST-316 LSI	1,2 x 1000		5			26,00
	1,6 x 1000		5			22,00
	2,0 x 1000		5			21,00
	2,4 x 1000		5			20,00

FIO DE SOLDAR
SÓLIDO

HYUNDAI
WELDING



• AÇO COBREDO • AÇO INOX-A2 • AÇO INOX-A4

AÇO COBREDO

HYUNDAI WELDING	DIÂMETRO [mm]	NORMA DIN	GÁS	PREÇO €/Kg
				Bobine 15 Kg
SM-70 ECO	0,80	DIN 8559:SG2	CO2 ; M21	4,58
	1,00	DIN 8559:SG2	CO2 ; M21	4,19
	1,20	DIN 8559:SG2	CO2 ; M21	3,99

AÇO INOX AISI 308

HYUNDAI WELDING	DIÂMETRO [mm]	NORMA DIN	GÁS	PREÇO €/Kg
				Bobine 15 Kg
SM-308 LSI	0,80	DIN 8559:SG2	CO2 ; M21	19,20
	1,00	DIN 8559:SG2	CO2 ; M21	18,60
	1,20	DIN 8559:SG2	CO2 ; M21	18,00

AÇO INOX AISI 316

HYUNDAI WELDING	DIÂMETRO [mm]	NORMA DIN	GÁS	PREÇO €/Kg
				Bobine 15 Kg
SM-316 LSI	0,80	DIN 8559:SG2	CO2 ; M21	26,40
	1,00	DIN 8559:SG2	CO2 ; M21	25,20
	1,20	DIN 8559:SG2	CO2 ; M21	25,20

**CAPACETE DE SOLDADURA
COM FILTRO DE AUTO ESCURECIMENTO
LINC SCREEN**



**CAPACETE DE SOLDADURA
COM FILTRO DE AUTO ESCURECIMENTO
LINC SCREEN**



**SEGURANÇA COM
PROTEÇÃO
CONFORTÁVEL E VISÃO
PERFEITA**

Os capacetes de soldadura com filtro de auto escurecimento *Linc Screen* foram concebidos para combinar a segurança com uma variedade de funções adequadas para cada tipo e método de soldadura.

O capacete *Linc Screen* é ideal para soldadura com eléctrodos, TIG e Mig. Um comando de grandes dimensões, localizado no exterior do capacete, permite um fácil ajuste do grau de escurecimento de 9 a 13 DIN. Dois comandos adicionais no suporte do filtro regulam o atraso na transição escuro para claro e a sensibilidade ao arco. Equipado com dois sensores de arco independentes e painéis de energia solar, é ideal para pequenas e médias oficinas de soldadura, reparações de carrocerias e equipamentos agrícolas.

Tabela de seleção

Método de soldadura	Uso
Eléctrodo (DC & AC)	✓
TIG DC	✓ >15A
TIG DC Pulsante	✗
TIG AC/DC	✓
MIG/MAG	✓
MIG/MAG Pulsante	✓
Corte por plasma	✗
Soldadura por plasma	✗
Soldadura oxiacetilénica	✗
Corte por gás	✗
Desbaste	✗

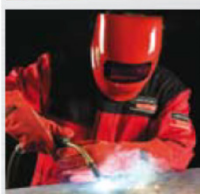

CARACTERÍSTICAS

- ✓ **Filtro de auto escurecimento**
melhora a eficiência e a precisão com o mais elevado nível de segurança
- ✓ **Design amigável**
combinado com ótica de precisão e eletrónica de alta tecnologia, permitem realizar soldaduras de máxima qualidade
- ✓ **Parâmetros ajustáveis**
para um máximo conforto pessoal em todas as condições de trabalho
- ✓ **Design leve**
- ✓ **Banda de transpiração substituível**
ajuda a manter o operador fresco e evita que o suor escorra para os olhos
- ✓ **Caixilho das lentes amovível**
para substituição das lentes anti salpicos
- ✓ **Apoios da cabeça totalmente ajustáveis**
para um melhor conforto
- ✓ **A mais elevada velocidade de transição claro/escuro**
- ✓ **Sensores de arco ativos e independentes**
- ✓ **Os capacetes de soldadura *Linc Screen* são produzidos com os mais elevados padrões de qualidade**

Especificações técnicas

Peso	Área de visão	Tempo transição	Ajuste de escuro	Função atraso	Proteção UVIR	Energia	Sensores de arco
516 g	96x42 mm	0,5 ms	4/9-13	0,1-0,9 s	até DIN 13	solar	2



DESIGNAÇÃO		PREÇO
Capacete de soldadura LINC SCREEN	1	160,00

BROCAS DE AÇO RÁPIDO
HSS ; HSS-CO 8%
DIN 338

KRINO

EMBALAGEM:
 Ø 0,25 a 8 mm - Cx 10 unid.
 Ø 8,1 a 16 mm - Cx 5 unid.
 Ø 17 a 20 mm - Cx 3 unid.



O encabadouro dos diâmetros 13 a 20 é reduzido para 13 mm.

Ø mm	HSS	HSS-CO 8%	Ø mm	HSS	HSS-CO 8%	Ø mm	HSS	HSS-CO 8%
1	23,54	162,97	6,25	71,23	724,26	11,5	223,32	1.689,92
1,25	24,15	217,28	6,5	64,58	543,19	11,75	301,77	3.017,73
1,5	21,74	162,97	6,75	84,49	814,79	12	259,52	1.810,63
1,75	25,96	241,42	7	75,45	633,72	12,25	313,84	3.017,73
2	24,15	156,93	7,25	102,61	965,68	12,5	277,64	2.112,41
2,25	26,57	253,50	7,5	90,53	663,91	12,75	344,01	3.319,50
2,5	24,15	175,03	7,75	114,68	1.026,04	13	295,74	2.233,12
2,75	26,57	283,67	8	102,61	784,61	13,5	482,83	2.897,02
3	24,15	175,03	8,25	126,75	1.207,10	14	470,77	2.957,37
3,25	33,79	319,88	8,5	114,68	844,97	14,5	573,38	3.621,28
3,5	30,78	223,32	8,75	144,85	1.327,81	15	573,38	3.923,05
3,75	35,61	337,99	9	129,76	1.026,04	15,5	724,26	4.828,36
4	32,59	241,42	9,25	168,99	1.629,57	16	724,26	4.828,36
4,25	42,25	380,23	9,5	150,89	1.086,38	16,5	844,97	5.431,91
4,5	38,02	277,64	9,75	181,06	1.810,63	17	844,97	5.431,91
4,75	45,27	434,54	10	159,94	1.146,74	17,5	905,32	6.035,46
5	41,04	301,77	10,25	211,24	2.112,41	18	905,32	6.035,46
5,25	56,74	525,09	10,5	190,11	1.327,81	18,5	1.026,04	6.639,01
5,5	51,30	404,37	10,75	241,42	2.414,18	19	1.026,04	6.639,01
5,75	62,77	573,38	11	211,24	1.508,86	19,5	1.207,10	7.846,09
6	57,34	416,45	11,25	259,52	2.715,96	20	1.207,10	7.846,09

FITA DE SERRA
AÇO AISI M 42 - 8% Co

KRINO

-Fita de serra de longa duração e resistente ao desgaste;
 -Ideal para linhas de fabricação industriais e mecânica geral;
 -Recomendada para máquinas automáticas e semi-automáticas de produção em aços de construção, aços ligados, INOX, alumínio, materiais não ferrosos; perfis grossos.

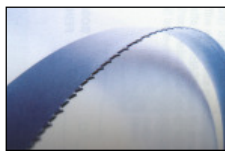

DENTIÇÃO: variável
 MATERIAL: AISI M42-8% Co
 HRC: 67/69



TRAVAÇÃO:



DIMENSÕES [mm]			DENTIÇÃO	PREÇO
Perímetro	Largura (h)	Espessura (s)	[Dentes / "']	
2090	20	0,9	5-8	3.575,00
			6-10	3.575,00
			8-12	3.575,00
			10-14	3.575,00
2375	20	0,9	5-8	4.026,00
			6-10	4.026,00
			8-12	4.026,00
			10-14	4.026,00
2450	27	0,9	5-8	4.235,00
			6-10	4.235,00
			8-12	4.235,00
			10-14	4.235,00
2750	27	0,9	5-8	4.730,00
			6-10	4.730,00
			8-12	4.730,00
2830	27	0,9	5-8	4.796,00
			6-10	4.796,00
			8-12	4.796,00

BROCAS HELICOIDAIS PARA METAIS DIN 338

ECEP

		LAMINADAS		RETIFICADAS		FRESADAS		GOLD-BLACK		COBALTO 5%		COBALTO 8%							
		SCUDO		SETTER		TeKno Xp		TeKno Xp Plus GOLD-BLACK <i>Especial para INOX</i>		TeKno Xp Co 5% <i>Especial para INOX</i>		TeKno Xp Co 8% <i>Especial para INOX</i>							
		CÓDIGO	PREÇO	CÓDIGO	PREÇO	CÓDIGO	PREÇO	CÓDIGO	PREÇO	CÓDIGO	PREÇO	CÓDIGO	PREÇO						
 <table border="1" style="margin: 10px auto;"> <tr><th>Ø</th><th>Unid.</th></tr> <tr><td>0,5 - 10</td><td>10 Unid.</td></tr> <tr><td>10,5 - 20</td><td>5 Unid.</td></tr> </table>	Ø	Unid.	0,5 - 10	10 Unid.	10,5 - 20	5 Unid.	Ø mm												
	Ø	Unid.																	
	0,5 - 10	10 Unid.																	
	10,5 - 20	5 Unid.																	
	0,5																		
	1	HSR0100	0,13	460100	0,29	50001	0,38	540100	0,47	570100	0,55	560100	0,52						
	1,5	HSR0150	0,13	460150	0,31	50150	0,38	540150	0,52	570150	0,64	560150	0,61						
	2	HSR0200	0,16	460200	0,32	50002	0,43	540200	0,60	570200	0,72	560200	0,81						
	2,25			460225	0,36	50225	0,48	540225	0,66	570225	0,82	560225	0,98						
	2,5	HSR0250	0,17	460250	0,36	50250	0,48	540250	0,66	570250	0,82	560250	0,98						
	2,75			460275	0,43	50275	0,64	540275	0,81	570275	0,92	560275	1,16						
	3	HSR0300	0,18	460300	0,43	50003	0,64	540300	0,81	570300	0,92	560300	1,16						
	3,25			460325	0,54	50325	0,81	540325	0,99	570325	1,15	560325	1,30						
	3,5	HSR0350	0,21	460350	0,54	50350	0,81	540350	0,99	570350	1,15	560350	1,30						
	3,75			460375	0,56	50375	0,94	540375	1,15	570375	1,33	560375	1,84						
	4	HSR0400	0,25	460400	0,56	50004	0,94	540400	1,15	570400	1,33	560400	1,84						
	4,25			460425	0,63	50425	1,20	540425	1,34	570425	1,66	560425	2,09						
	4,5	HSR0450	0,30	460450	0,63	50450	1,20	540450	1,34	570450	1,66	560450	2,09						
	4,75			460475	0,75	50475	1,37	540475	1,80	570475	1,94	560475	2,37						
	5	HSR0500	0,36	460500	0,75	50005	1,37	540500	1,80	570500	1,94	560500	2,37						
	5,25			460525	0,79	50525	1,58	540525	2,06	570525	2,28	560525	2,96						
	5,5	HSR0550	0,43	460550	0,79	50550	1,58	540550	2,06	570550	2,28	560550	2,96						
	5,75			460575	0,98	50575	1,70	540575	2,20	570575	2,53	560575	3,44						
	6	HSR0600	0,47	460600	0,98	50006	1,70	540600	2,20	570600	2,53	560600	3,44						
	6,25			460625	1,12	50625	1,76	540625	2,60	570625	2,98	560625	4,13						
6,5	HSR0650	0,56	460650	1,12	50650	1,76	540650	2,60	570650	2,98	560650	4,13							
6,75			460675	1,33	50675	2,09	540675	3,16	570675	3,49	560675	4,98							
7	HSR0700	0,71	460700	1,33	50007	2,09	540700	3,16	570700	3,49	560700	4,98							
7,25			460725	1,47	50725	2,36	540725	3,58	570725	4,12	560725	5,72							
7,5	HSR0750	0,77	460750	1,47	50750	2,36	540750	3,58	570750	4,12	560750	5,72							
7,75			460775	1,81	50775	2,67	540775	4,14	570775	5,02	560775	7,51							
8	HSR0800	0,90	460800	1,81	50008	2,67	540800	4,14	570800	5,02	560800	7,51							
8,25			460825	1,93	50825	3,02	540825	4,70	570825	5,56	560825	9,17							
8,5			460850	1,93	50850	3,02	540850	4,70	570850	5,56	560850	9,17							
8,75			460875	2,25	50875	3,42	540875	5,32	570875	6,27	560875	9,89							
9	HSR0900	1,12	460900	2,25	50009	3,42	540900	5,32	570900	6,27	560900	9,89							
9,25			460925	2,50	50925	3,88	540925	5,85	570925	6,91	560925	10,64							
9,5			460950	2,50	50950	3,88	540950	5,85	570950	6,91	560950	10,64							
9,75			460975	2,85	50975	4,43	540975	6,81	570975	8,02	560975	12,46							
10	HSR1000	1,48	461000	2,85	50010	4,43	541000	6,81	571000	8,02	561000	12,46							
10,5			461050	3,14	51050	4,97	541050	7,62	571050	8,88	561050	14,21							
11			461100	3,67	50011	5,72	541100	8,68	571100	10,19	561100	16,26							
11,5			461150	3,99	51150	5,96	541150	9,45	571150	11,14	561150	17,61							
12			461200	4,43	50012	6,67	541200	10,66	571200	12,64	561200	19,83							
12,5			461250	5,22	51250	7,15	541250	11,57	571250	13,64	561250	21,39							
13			461300	5,22	50013	7,67	541300	12,28	571300	14,66	561300	23,29							
13,5			461350	7,85	53135	10,58						37,46							
14			461400	7,85	53140	10,81						36,96							
14,5			461450	9,04	53145	11,71						45,26							
15			461500	9,04	53150	12,49						49,04							
15,5			461550	10,21	53155	12,56						60,35							
16			461600	10,21	53160	14,52						60,35							
16,5			461650	11,94	53165	15,40						67,90							
17			461700	11,94	53170	16,33						67,90							
17,5			461750	14,72	53175	17,39						75,45							
18			461800	14,72	53180	18,85						75,45							
18,5			461850	15,78	53185	20,19						82,99							
19			461900	15,78	53190	20,95						82,99							
19,5			461950	18,03	53195	22,08						98,08							
20			462000	18,03	53200	22,43						98,08							
21					53211	25,24													
22					53220	26,89													
23					53230	29,58													
24					53240	31,92													
25					53260	34,50													

BROCAS HELICOIDAIS PARA METAIS
SÉRIE LONGA - DIN 340
SÉRIE EXTRALONGA - DIN 1869

ECEF

TeKno Xp

SÉRIE LONGA - DIN 340



TeKno Xp

SÉRIE EXTRALONGA - DIN 1869

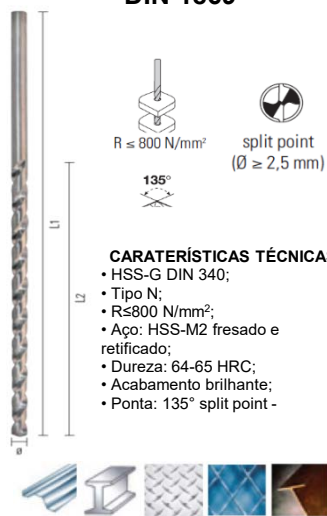

TeKno Xp

SÉRIE LONGA - DIN 340



Ø mm	FRESADAS - LONGAS				FRESADAS - EXTRALONGAS				FRESADAS - LONGAS			
	DIN 340				DIN 1869				DIN 340			
	L1	L2	CÓDIGO	PREÇO	L1	L2	CÓDIGO	PREÇO	L1	L2	CÓDIGO	PREÇO
0,5												
1	56	33	58010	0,67	90	56	78010090	4,52	56	33	590100	1,04
1,5	70	45	58015	0,68	110	75	78015110	5,25	70	45	590150	1,07
2	85	56	58020	0,90	125	85	78020125	5,25	85	56	590200	1,43
2,25	90	59	58022	1,12					90	59	590225	1,79
2,5	95	62	58025	1,12	140	95	78025140	5,76	95	62	590250	1,79
2,75	100	66	58027	1,28					100	66	590275	2,08
3	100	66	58030	1,28	150	100	78030150	5,94	100	66	590300	2,08
3,25	106	69	58032	1,43					106	69	590325	2,54
3,5	112	73	58035	1,43	165	115	78035165	8,83	112	73	590350	2,54
3,75	112	73	58037	1,62					112	73	590375	2,99
4	119	78	58040	1,62	175	120	78040175	10,01	119	78	590400	2,99
4,25	119	78	58042	2,02					119	78	590425	3,84
4,5	126	82	58045	2,02	185	125	78045185	10,74	126	82	590450	3,84
4,75	126	82	58047	2,08					126	82	590475	4,27
5	132	87	58050	2,08	195	135	78050195	12,39	132	87	590500	4,27
5,25	132	87	58052	2,65					132	87	590525	5,22
5,5	139	91	58055	2,65	205	140	78055205	15,50	139	91	590550	5,22
5,75	139	91	58057	2,98					139	91	590575	6,26
6	139	91	58060	2,98	205	140	78060205	15,50	139	91	590600	6,26
6,25	148	97	58062	3,30					148	97	590625	7,50
6,5	148	97	58065	3,30	215	150	78065215	17,06	148	97	590650	7,50
6,75	148	97	58067	3,89					148	97	590675	9,02
7	156	102	58070	3,89	225	155	78070225	19,49	156	102	590700	9,02
7,25	156	102	58072	4,43								
7,5	156	102	58075	4,43	225	155	78075225	21,06	156	102	590750	10,01
7,75	165	109	58077	5,04								
8	165	109	58080	5,04	240	165	78080240	23,30	165	109	590800	11,63
8,25	165	109	58082	5,58								
8,5	165	109	58085	5,58	240	165	78085240	29,52	165	109	590850	12,67
8,75	175	115	58087	6,34								
9	175	115	58090	6,34	250	175	78090250	35,65	175	115	590900	14,80
9,25	175	115	58092	6,88								
9,5	175	115	58095	6,88	250	175	78095250	36,28	175	115	590950	16,52
9,75	184	121	58097	8,16								
10	184	121	58100	8,16	265	185	78100265	40,16	184	121	591000	18,97
10,5	184	121	58105	9,14	265	185	78105265	43,45	184	121	591050	22,07
11	196	128	58110	10,37	280	195	78110280	44,77	196	128	591100	25,63
11,5	195	128	58115	11,15	280	195	78115280	49,65	195	128	591150	27,54
12	205	134	58120	12,35	295	205	78120295	54,30	205	134	591200	30,71
12,5	205	134	58125	15,74	295	205	78125295	54,30	205	134	591250	38,52
13	205	134	58130	17,11	295	205	78130295	57,40	205	134	591300	41,14
13,5												
14												
14,5												
15												
15,5												
16												
16,5												
17												
17,5												
18												
18,5												
19												
19,5												
20												
21												
22												
23												
24												
25												

BROCAS CRANEANAS BIMETÁLICAS - HSS E ACESSÓRIOS

ECEEF



- Aço HSS bimetalico;
- Altura útil: 30 mm;
- Máxima espessura furável:
 - 3 mm em ferro;
 - 30 mm em plástico e aglomerado;
- Dentição variável com ataque positivo.



VELOCIDADE ACONSELHADA (r.p.m.)

Ø [mm]	GESSO CARTONADO	PLÁSTICO	MADEIRA	ALUMÍNIO	LATÃO	FERRO
14-17	900	650	900	825	730	550
19-24	670	500	670	635	560	400
25-32	510	350	510	450	400	300
33-38	390	300	390	375	330	250
40-44	320	250	320	305	270	210
46-51	280	220	280	270	240	180
52-57	250	200	250	240	210	160
59-64	230	170	230	220	190	140
65-70	200	150	200	195	170	130
73-79	180	130	180	170	150	115
83-89	160	120	160	150	130	100
92-98	140	100	140	135	120	90
102-108	130	90	130	120	110	80
111-121	120	80	120	105	100	75
127-140	100	70	100	85	85	60
146-152	95	65	95	75	75	55
160-200	80	55	80	60	60	35

BIMETÁLICA		
Ø mm	CÓDIGO	PREÇO
14	57014	5,29
16	57016	5,41
17	57017	5,52
19	57019	5,75
20	57020	5,75
21	57021	5,87
22	57022	6,21
24	57024	6,56
25	57025	6,79
27	57027	7,02
29	57029	7,36
30	57030	7,59
32	57032	7,94
33	57033	8,28
35	57035	8,63
37	57037	8,86
38	57038	9,32
40	57040	9,66
41	57041	9,78
43	57043	10,01
44	57044	10,47
46	57046	11,04
48	57048	11,40
51	57051	11,52
52	57052	12,12
54	57054	11,88
57	57057	12,60
59	57059	12,84
60	57060	13,20
64	57064	13,68
65	57065	14,76
67	57067	14,88
68	57068	14,88
70	57070	15,36
73	57073	15,84
76	57076	16,32
79	57079	16,80
83	57083	17,28
86	57086	18,12
89	57089	18,72
92	57092	19,44
95	57095	20,52
98	57098	23,35
102	57102	24,22
105	57105	25,97
108	57108	26,53
111	57111	27,20
114	57114	28,18
121	57121	29,61
127	57127	31,19
140	57140	33,92
146	57146	35,21
152	57152	36,65

SUPORTES COMPLETOS DE BROCAS E BROCAS DE CENTRO PARA BROCAS CRANEANAS BIMETÁLICAS

SUPORTES COMPLETOS

Cód.	Imagem	Descrição	Imagem	TAMANHO	CÓDIGO	PREÇO
57514		Encabadouro circular Ø6,35 mm	1 Unid.	Ø14-Ø30	57514	6,69
57545		Encabadouro hexagonal Ø 11 mm	1 Unid.	Ø32-Ø200	57545	13,88

BROCAS PILOTO (DE CENTRO)

Cód.	Imagem	Descrição	Imagem	TAMANHO	CÓDIGO	PREÇO
57534		Ø6,35x80 mm	1 Unid.	Ø6,35x80	57534	2,90
57535		Ø6,35x108 mm	1 Unid.	Ø6,35x108	57535	3,47

BROCAS DE FRESA PARA MÁQUINAS COM BASE ELETROMAGNÉTICA

ECEF



Tabela de aplicações

Metal	Utilização
ferro	★ ★ ★
aço	★ ★ ★
perfis laminados	★ ★ ★
alumínio	★ ★ ★
latão	★ ★ ★
bronze	★ ★
cobre	★ ★
ferro fundido	★ ★ ★
aço inox	★

HSS M2+AL FRESA DE COROA com dupla geometria para uma centragem perfeita. Tratamento térmico para uma elevada duração de utilização. Capacidade de perfuração superior: resultados duas vezes superiores às fresas de coroa normais HSS, ou às brocas com encabadouro cônico morse HSS-G.

- **HSS-G M2+Alumínio - CBN-fresado**
- Adequado para todas as máquinas com base magnética com encabadouro **WELDON** (3/4" - 19 mm) do tipo: ALFRA, BDS, BUX, EUROBOR, JANCY, MAGNETOR, MAGTRON, ROTABROACH, RUKO, HITACHI, etc.
- **HRC 66-68**
- **Aplicações:** para perfurações em aço, ferro fundido, aços ligados, metais não ferrosos.

Velocidade aconselhada (r.p.m.)

Ø [mm]	Ligas leves	Aço macio	Ferro fundido
12-14	800	700	240
15-17	530	610	200
18-20	380	530	180
21-23	290	460	160
24-26	250	400	140
27-30	200	340	120
31-34	185	300	110
35-40	170	270	100
41-45	130	240	80
46-50	100	180	60

Ø mm	TEKNO TOP <small>profissionais</small> FUTURE				
	PROFUNDIDADE DO FURO [mm]	EMCABADOURO Ø [mm]	Nº DE DENTES	CÓDIGO	PREÇO
12	30	19 (3/4")	4	3001230	28,73
13	30	19 (3/4")	4	3001330	28,73
14	30	19 (3/4")	4	3001430	32,88
15	30	19 (3/4")	4	3001530	37,31
16	30	19 (3/4")	5	3001630	37,31
17	30	19 (3/4")	5	3001730	37,31
18	30	19 (3/4")	5	3001830	39,67
19	30	19 (3/4")	6	3001930	40,97
20	30	19 (3/4")	6	3002030	42,65
21	30	19 (3/4")	6	3002130	44,33
22	30	19 (3/4")	6	3002230	45,16
23	30	19 (3/4")	6	3002330	47,41
24	30	19 (3/4")	6	3002430	49,61
25	30	19 (3/4")	7	3002530	51,97
26	30	19 (3/4")	7	3002630	56,09
27	30	19 (3/4")	7	3002730	59,39
28	30	19 (3/4")	8	3002830	60,17
29	30	19 (3/4")	8	3002930	63,25
30	30	19 (3/4")	8	3003030	64,45
31	30	19 (3/4")	8	3003130	68,68
32	30	19 (3/4")	8	3003230	70,15
33	30	19 (3/4")	8	3003330	73,27
34	30	19 (3/4")	8	3003430	75,08
35	30	19 (3/4")	9	3003530	77,08
36	30	19 (3/4")	9	3003630	81,32
37	30	19 (3/4")	9	3003730	83,41
38	30	19 (3/4")	9	3003830	85,27
39	30	19 (3/4")	9	3003930	87,64
40	30	19 (3/4")	10	3004030	89,32
42	30	19 (3/4")	12	3004230	105,60
45	30	19 (3/4")	12	3004530	123,40
50	30	19 (3/4")	12	3005030	140,05

JOGOS DE MACHOS MANUAIS E VIRA-MACHOS

ECEF

ACO HSS-G

- HSS-G Retificado - DIN 352
- $R \leq 800 \text{ N/mm}^2$
- HRC: 63-64
- Rosca métrica - ISO DIN 13 passo normal



ACO C.V. (CROMO-VANÁDIO)

- C.V. - DIN 352
- $R \leq 600 \text{ N/mm}^2$
- HRC: 62-63
- Rosca métrica - ISO passo normal



JOGOS DE 3 MACHOS MANUAIS ROSCA MÉTRICA - PASSO NORMAL



- Corte inicial;
- Corte médio;
- Corte final.



Ø [mm]	Passo [mm]	L1 [mm]	L2 [mm]	AÇO HSS-G		AÇO CV	
				Código	Preço	Código	Preço
M 2	0,40	36	10	102	9,20	702	4,20
M 3	0,50	40	12	103	9,20	703	3,49
M 4	0,70	45	14	104	9,20	704	3,49
M 5	0,80	48	16	105	9,20	705	3,49
M 6	1,00	50	18	106	10,73	706	3,95
M 7	1,00	50	18	107	13,37	707	4,25
M 8	1,25	56	22	108	13,37	708	4,87
M 10	1,50	70	25	110	17,99	710	6,48
M 12	1,75	75	30	112	23,84	712	7,79
M 14	2,00	80	32	114	31,16	714	10,76
M 16	2,00	80	32	116	38,88	716	12,79
M 18	2,50	95	40	118	50,64	718	16,92
M 20	2,50	95	40	120	59,41	720	18,24
M 24	3,00	110	50	124	91,79	724	31,97

MACHO MANUAL DE CORTE FINAL ROSCA MÉTRICA - PASSO NORMAL

- Corte final.



Ø [mm]	Passo [mm]	L1 [mm]	L2 [mm]	AÇO HSS-G		AÇO CV	
				Código	Preço	Código	Preço
M 3	0,50	40	12	203	3,22	903	1,33
M 4	0,70	45	14	204	3,22	904	1,33
M 5	0,80	48	16	205	3,22	905	1,36
M 6	1,00	50	18	206	3,41	906.1	1,43
M 8	1,25	56	22	208	4,18	908.1	1,79
M 10	1,50	70	25	210	6,10	910.1	2,24
M 12	1,75	75	30	212	8,08	912.1	2,75
M 14	2,00	80	32	214	10,56	914.1	3,80
M 16	2,00	80	32	216	13,39	916.1	4,78

JOGOS DE 2 MACHOS MANUAIS ROSCA MÉTRICA - PASSO FINO

- Corte inicial;
- Corte final.

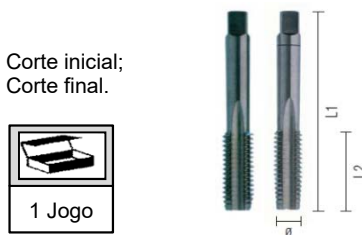

Ø [mm]	Passo [mm]	L1 [mm]	L2 [mm]	AÇO HSS-G		AÇO CV	
				Código	Preço	Código	Preço
M 6	0,75	50	18	406.1	7,22	806	2,71
M 8	1,00	56	22	408.2	9,05	808.1	3,01
M 10	1,00	70	25	410.1	12,41	810.1	4,44
	1,25	70	25	410.2	12,41	810.2	4,44
M 12	1,25	75	30	412.2	16,25	812.2	5,09
	1,50	75	30	412.3	16,25	812.3	5,09
M 14	1,50	80	32	414.3	22,01	814.3	7,45
M 16	1,50	80	32	416.2	26,77	816.3	8,52

VIRA-MACHOS



AJUSTÁVEIS

DIN 1814



N.º	Machos	L1 [mm]	Código	Preço
0	M1 - M8	130	935	5,26
1	M1 - M10	188	945	6,12
1.1/2	M1 - M12	215	955	6,23
2	M4 - M12	280	960	12,89
3	M5 - M20	380	965	24,59
4	M11 - M27	500	975	33,20
1	M3 - M10	85	181	12,07
2	M5 - M12	100	182	15,25
10	M3 - M10	250	183	18,92
20	M5 - M12	310	184	22,97
1	M3 - M8	62	171	4,67
2	M5 - M10	78	172	5,68
3	M5 - M12	102	173	7,16

DE BUCHA COM ROQUETE (REVERSÍVEL)



DE BUCHA SEM ROQUETE



CAÇONETES REDONDAS AJUSTÁVEIS PARA ABERTURA DE ROSCA MÉTRICA PASSO NORMAL + PASSO FINO

ECEF

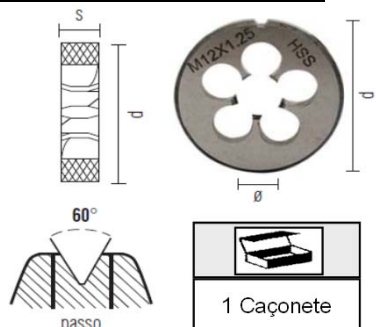

AÇO HSS-G

- HSS-G Retificado - DIN 223
- $R \leq 800 \text{ N/mm}^2$
- HRC: 63-64
- Rosca métrica - ISO DIN 13 passo normal
- Tolerância 6G

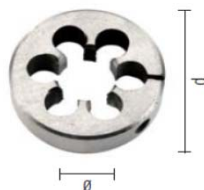

AÇO C.V. (CROMO-VANÁDIO)

- C.V. - DIN 223
- $R \leq 600 \text{ N/mm}^2$
- HRC: 62-63
- Rosca métrica - ISO passo normal



Ø [mm]	Passo [mm]	AÇO HSS-G				AÇO CV (CROMO-VANÁDIO)			
		d [mm]	s [mm]	Código	Preço	d [mm]	s [mm]	Código	Preço
M 3	0,50 (N)	20	5	303	4,91	25,4	9	1003	2,96
M 4	0,70 (N)	20	5	304	5,18	25,4	9	1004	2,96
M 5	0,80 (N)	20	7	305	5,18	25,4	9	1005	2,96
M 6	0,75 (F)	20	7	306.1	5,18	25,4	9	1006	2,96
	1,00 (N)	20	7	306	5,18	25,4	9	1006.1	2,96
M7	1,00 (N)	25	9	307	7,98	25,4	9	1007.1	2,96
M 8	1,00 (F)	25	9	308.2	7,98	25,4	9	1008.1	2,96
	1,25 (N)	25	9	308	7,98	25,4	9	1008.2	2,96
M 10	1,00 (F)	30	11	310.1	12,26	38,1	14	1010.1	5,90
	1,25 (F)	30	11	310.2	12,26	38,1	14	1010.2	5,90
	1,50 (N)					25,4	9	1010.4R	2,96
	1,50 (N)	30	11	310	12,26	38,1	14	1010.3	5,39
M 12	1,25 (F)	38	10	312.2	20,19	38,1	14	1012.2	5,90
	1,50 (F)	38	10	312.3	20,19	38,1	14	1012.3	5,90
	1,75 (N)	38	14	312	20,19	38,1	14	1012.4	5,39
M 14	1,50 (F)	38	10	314.3	20,19	38,1	14	1014.3	5,90
	2,00 (N)	38	14	314	20,19	38,1	14	1014.5	5,39
M 16	1,50 (F)	45	14	316.3	34,24	38,1	14	1016.3	5,90
	2,00 (N)	45	18	316	34,24	38,1	14	1016.5	5,39
M 18	2,50 (N)	45	18	318	34,24	50,8	16	1018.6	11,50
M 20	2,50 (N)	45	18	320	34,24	50,8	16	1020.6	11,50
M 22	2,50 (N)	55	22	322	50,34	50,8	16	1022.6	11,50
M 24	3,00 (N)	55	22	324	50,34	50,8	16	1024.7	11,50

PORTA-CAÇONETES DIN 225

ECEF

PORTA-CAÇONETES DIN 225



DIN 225



N.º	Medidas [mm]	Caçonetes	L1 [mm]	Código	Preço
1	20 x 5	M3 - M4	200	1075	4,93
2	20 x 7	M4,5 - M6	220	1080	4,93
3	25 x 9	M7 - M9	225	1085	6,05
4	30 x 11	M10 - M11	280	1090	7,79
5	38 x 14	M12 - M14	320	1095	10,93
6	45 x 18	M16 - M20	450	1100	15,08
7	55 x 22	M22 - M24	580	1105	22,64

**SET DE MACHOS MANUAIS
PARA ABERTURA DE ROSCA MÉTRICA
PASSO NORMAL**

ECEF



- Corte inicial;
- Corte médio;
- Corte final.

AÇO HSS-G

- HSS-G Retificado - DIN 352
- $R \leq 800 \text{ N/mm}^2$
- HRC: 63-64
- Rosca métrica - ISO DIN 13 passo normal

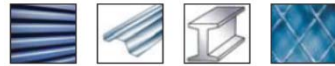

**Machos
(21)**

AÇO HSS-G

Código

Preço

- M 3 (x3)
- M 4 (x3)
- M 5 (x3)
- M 6 (x3)
- M 8 (x3)
- M 10 (x3)
- M 12 (x3)

190

93,25



1 Set

Estojo em metal
21 peças

**SET DE MACHOS E CAÇONETES
PARA ABERTURA DE ROSCA MÉTRICA
PASSO NORMAL - COM ACESSÓRIOS**

ECEF



Machos:

- Corte inicial;
- Corte médio;
- Corte final.

AÇO HSS-G

- HSS-G Retificado - DIN 352
- $R \leq 800 \text{ N/mm}^2$
- HRC: 63-64
- Rosca métrica - ISO DIN 13 passo normal



Estojo em metal
32 peças



1 Set

Acessórios	Caçonetes (7)	Machos (21)	AÇO HSS-G	
			Código	Preço
1 Vira-Machos N.º 1.1/2	M 3	M 3 (x3)	290	148,87
1 Porta-Caçonetes 25x9	M 4	M 4 (x3)		
	M 5	M 5 (x3)		
1 Conta-fios	M 6	M 6 (x3)		
	M 8	M 8 (x3)		
	M 10	M 10 (x3)		
1 Chave de fendas	M 12	M 12 (x3)		

**EXTRATORES DE PARAFUSOS
AÇO Cr-V**

ECEF



5 Peças

6 Peças



1 Set

SETs		AÇO Cr-V	
		Código	Preço
5 PEÇAS	3-6; 6-8; 8-11; 11-14; 14-18	E5000	5,98
6 PEÇAS	3-6; 6-8; 8-11; 11-14; 14-18; 18-24	E6000	9,86

MACHOS PARA MÁQUINA

ECEF

ACO HSS-Co

- DIN 371/B
- HSS-Co Retificado - AISI M35
- $R \leq 850 \text{ N/mm}^2$
- **PARA INOX**
- Rosca métrica - ISO passo normal



ACO HSS-G

- DIN 371/B
- HSS-G Retificado - AISI M2
- $R \leq 750 \text{ N/mm}^2$
- Rosca métrica - ISO passo normal



MACHOS PARA MÁQUINA	Ø [mm]	Passo [mm]	L1 [mm]	L2 [mm]	ACO HSS-Co		ACO HSS-G	
					Código	Preço	Código	Preço
FORMA B - ROSCA MÉTRICA DIN 371/B - PASSO NORMAL - RETIFICADO • Haste reforçada 	M 3	0,50	56	11	5003C	10,97	5003	7,59
	M 4	0,70	63	13	5004C	10,97	5004	7,59
	M 5	0,80	70	16	5005C	11,54	5005	7,94
	M 6	1,00	80	19	5006C	13,85	5006	8,36
	M 8	1,25	90	22	5008C	20,70	5008	10,55
	M 10	1,50	100	24	5010C	27,56	5010	13,16
FORMA B - ROSCA MÉTRICA DIN 376/B - PASSO NORMAL - RETIFICADO • Haste rebaixada; • Para furos passantes de grande profundidade em aços, ferro fundido e metais não-ferrosos. 	M 3	0,50	56	11			5103	7,59
	M 4	0,70	63	13			5104	7,59
	M 5	0,80	70	16			5105	7,94
	M 6	1,00	80	19			5106	8,36
	M 8	1,25	90	22			5108	10,55
	M 10	1,50	100	24			5110	13,16
FORMA C - ROSCA MÉTRICA DIN 371/C - PASSO NORMAL - RETIFICADO • Haste reforçada 	M 3	0,50	56	11	5203C	9,86	5203	6,95
	M 4	0,70	63	13	5204C	9,86	5204	8,24
	M 5	0,80	70	16	5205C	10,46	5205	7,25
	M 6	1,00	80	19	5206C	12,77	5206	7,71
	M 8	1,25	90	22	5208C	18,65	5208	9,81
	M 10	1,50	100	24	5210C	24,51	5210	12,21
FORMA C - ROSCA MÉTRICA DIN 376/C - PASSO NORMAL - RETIFICADO • Haste rebaixada; • Para furos passantes de grande profundidade em aços, ferro fundido e metais não-ferrosos. 	M 3	0,50	56	11			5303	6,95
	M 4	0,70	63	13			5304	6,95
	M 5	0,80	70	16			5305	7,25
	M 6	1,00	80	19			5306	7,71
	M 8	1,25	90	22			5308	9,81
	M 10	1,50	100	24			5310	12,21
FORMA C 15° - ROSCA MÉTRICA DIN 371/C 15° - PASSO NORMAL - RETIFICADO • Haste reforçada 	M 3	0,50	56	11	5403C	12,09	5403	8,40
	M 4	0,70	63	13	5404C	12,09	5404	8,40
	M 5	0,80	70	16	5405C	12,81	5405	8,79
	M 6	1,00	80	19	5406C	15,21	5406	9,35
	M 8	1,25	90	22	5408C	22,41	5408	11,91
	M 10	1,50	100	24	5410C	31,86	5410	14,70
FORMA C 15° - ROSCA MÉTRICA DIN 376/C 15° - PASSO NORMAL - RETIFICADO • Haste rebaixada; • Para furos passantes de grande profundidade em aços, ferro fundido e metais não-ferrosos. 	M 3	0,50	56	11			5503	8,40
	M 4	0,70	63	13			5504	8,40
	M 5	0,80	70	16			5505	8,79
	M 6	1,00	80	19			5506	9,35
	M 8	1,25	90	22			5508	11,91
	M 10	1,50	100	24			5510	14,70
FORMA C 35° - ROSCA MÉTRICA DIN 371/C 35° - PASSO NORMAL - RETIFICADO • Haste reforçada 	M 3	0,50	56	11	5603C	12,09	5603	8,40
	M 4	0,70	63	13	5604C	12,09	5604	8,40
	M 5	0,80	70	16	5605C	12,81	5605	8,79
	M 6	1,00	80	19	5606C	15,21	5606	9,35
	M 8	1,25	90	22	5608C	22,41	5608	11,91
	M 10	1,50	100	24	5610C	31,86	5610	14,70
FORMA C 35° - ROSCA MÉTRICA DIN 376/C 35° - PASSO NORMAL - RETIFICADO • Haste rebaixada; • Para furos passantes de grande profundidade em aços, ferro fundido e metais não-ferrosos. 	M 3	0,50	56	11			5703	8,40
	M 4	0,70	63	13			5704	8,40
	M 5	0,80	70	16			5705	8,79
	M 6	1,00	80	19			5706	9,35
	M 8	1,25	90	22			5708	11,91
	M 10	1,50	100	24			5710	14,70

UTENSÍLIO COMBINADO PARA FURAR, ROSCAR E ESCARIAR SIMULTANEAMENTE

ECEEF

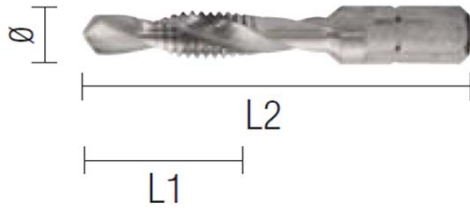

- Haste hexagonal ¼"
- Broca autocentrante
- Para aço, aços ligados e metais não-ferrosos

AÇO HSS-G

- HSS-G Retificado - AISI M2
- R ≤ 750 N/mm²
- Rosca métrica - ISO passo normal

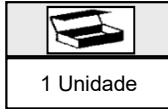

Caixa metálica

Produto	Ø [mm]	Passo [mm]	L1 [mm]	L2 [mm]	AÇO HSS-G	
					Código	Preço
UTENSÍLIO COMBINADO	M 3	0,50	2,5	36	6103	9,88
	M 4	0,70	3,3	39	6104	9,88
	M 5	0,80	4,2	41	6105	9,88
	M 6	1,00	5	44	6106	9,88
	M 8	1,25	6,8	50	6108	11,03
M 10	1,50	8,5	59	6110	12,63	
JOGO DE UTENSÍLIOS COMBINADOS	Ø 3-4-5-6-8-10 mm + Extensão hexagonal				6100 SET	60,00

FRESAS ROTATIVAS EM METAL DURO - CORTE A DIAMANTE -

ECEEF

- **Corte a diamante;**
- **Velocidade aconselhada:**
350-450 rpm.

METAL DURO K20

- Carboneto de Tungstênio
- Haste Ø6 x 40 mm
- Corte a diamante
- Dureza acima de 90 HRC
- Para trabalhos de acabamento em aços temperados, aços inoxidáveis, aços ligados, metais em geral, etc.



FORMA	Dimensões [mm]	METAL DURO K20	
		Código	Preço
A - CILÍNDRICA ponta plana 	6 x 16	195106	13,07
	8 x 20	195108	17,19
	10 x 20	195110	20,92
	12 x 25	195112	29,35
B - CILÍNDRICA ponta cortante 	6 x 16	195206	13,07
	8 x 20	195208	17,19
	10 x 20	195210	20,92
	12 x 25	195212	29,35
K - FORMA DE CHAMA 	6 x 18	195306	13,07
	8 x 18	195308	17,19
	10 x 20	195310	20,92
	12 x 25	195312	29,35
C - CILÍNDRICA BOLEADA 	6 x 16	195406	13,07
	8 x 20	195408	17,19
	10 x 20	195410	20,92
	12 x 25	195412	29,35
EXTENSÃO PARA FRESAS ROTATIVAS 	L = 65	195999	9,79

DISCOS DIAMANTADOS



DISCOS DIAMANTADOS - SINTERIZADOS - SEGMENTADOS - CCS 101

Aplicação: Uso geral em betão, tijolo, materiais de construção, pedra, etc.

 <p>9" DRY 230 x 22.23 x 7mm Cool pressed Diamond saw blade for Concrete 6.600 MAX RPM CCS 101***</p>	TAMANHO (Ø)		FURO		SEGMENTOS		QUALIDADE	PREÇO/ Unidade
	[mm]	["]	[mm]	["]	DIMENSÕES	Nº		
	115	4,5	20/22,23	20/ 7/8	2,0x10x35	9	STANDARD	3,50
							PROFISSIONAL	5,30
	230	9	22,23/25,4/30	7/8/1/1 1/5/2	2,5x10x35	18	STANDARD	10,50
							PROFISSIONAL	13,30

DISCOS DIAMANTADOS - SINTERIZADOS - BANDA CONTÍNUA - CCC 101

Aplicação: Azulejos, telhas cerâmicas, mármore.

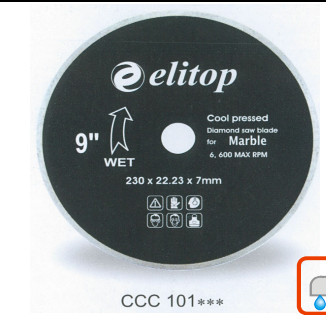
 <p>9" WET 230 x 22.23 x 7mm Cool pressed Diamond saw blade for Marble 6.600 MAX RPM CCC 101***</p>	TAMANHO (Ø)		FURO		SEGMENTOS		QUALIDADE	PREÇO/ Unidade
	[mm]	["]	[mm]	["]	DIMENSÕES	Nº		
	115	4,5	20/22,23	20/ 7/8	1,9x7,0		STANDARD	3,60
							PROFISSIONAL	5,40
	230	9	22,23/25,4/30	7/8/1/1 1/5/2	2,4x7,0		STANDARD	10,90
							PROFISSIONAL	13,70

DISCOS DIAMANTADOS - SINTERIZADOS - TURBO - CCT 201

Aplicação: Uso geral em granito, mármore, telhas, materiais de construção, etc.

 <p>9" TURBO 230 x 22.23 x 7.5mm Cool pressed Diamond saw blade for Granite 6.600 MAX RPM CCT 201***</p>	TAMANHO (Ø)		FURO		SEGMENTOS		QUALIDADE	PREÇO/ Unidade
	[mm]	["]	[mm]	["]	DIMENSÕES	Nº		
	115	4,5	20/22,23	20/ 7/8	2,2x7,5		STANDARD	3,90
							PROFISSIONAL	5,60
	230	9	22,23/25,4/30	7/8/1/1 1/5/2	2,6x8,0		STANDARD	11,40
							PROFISSIONAL	15,00

DISCOS DIAMANTADOS - SINTERIZADOS - SEGMENTADOS - CCS 111

Aplicação: Uso geral em granito, mármore, telhas, betão, materiais de construção, etc.

 <p>9" DRY 230 x 22.23 x 7.5mm Cool pressed Diamond saw blade for Concrete 6.600 MAX RPM CCS 111***</p>	TAMANHO (Ø)		FURO		SEGMENTOS		QUALIDADE	PREÇO/ Unidade
	[mm]	["]	[mm]	["]	DIMENSÕES	Nº		
	115	4,5	20/22,23	20/ 7/8	2,0x7,5x35	9	STANDARD	4,20
							PROFISSIONAL	6,20
	230	9	22,23/25,4	7/8/1/1 1/5/2	2,5x7,5x35	18	STANDARD	12,80
							PROFISSIONAL	15,90

DISCOS DIAMANTADOS



DISCOS DIAMANTADOS - SINTERIZADOS - SEGMENTADOS - CCS 107

Aplicação: Corte rápido em betão, tijolo, materiais de construção, pedra, etc.

 <p>CCS 107***</p>	TAMANHO (Ø)		FURO		SEGMENTOS		QUALIDADE	PREÇO/ Unidade
	[mm]	["]	[mm]	["]	DIMENSÕES	Nº		
	115	4,5	22,23/25,4	7/8 /1	2,2x7,5	9	STANDARD	4,10
							PROFISSIONAL	6,20
	230	9	22,23/25,4	7/8/1/1 1/5/2	2,6x8	18	STANDARD	13,50
							PROFISSIONAL	16,70

DISCOS DIAMANTADOS - LASER - SEGMENTADOS - CLS 111 , CLS 117

Aplicação: Materiais de construção..

 <p>CLS 117</p>	TAMANHO (Ø)		FURO		SEGMENTOS		QUALIDADE	PREÇO/ Unidade	
	[mm]	["]	[mm]	["]	DIMENSÕES	Nº			
	CLS111	115	4,5	20/22,23	20/ 7/8	2,0x7x32	9	PROFISSIONAL	20,00
		230	9	20/22,23	20/ 7/8	2,5x7x40	16	PROFISSIONAL	50,00
	CLS117	115	4,5	20/22,23	20/ 7/8	2,0x7x32	9	PROFISSIONAL	20,00
		230	9	20/22,23	20/ 7/8	2,5x7x40	16	PROFISSIONAL	50,00

DISCOS DIAMANTADOS - LASER - SEGMENTADOS - CLS 121

Aplicação: Granito.

 <p>CLS 121***</p>	TAMANHO (Ø)		FURO		SEGMENTOS		QUALIDADE	PREÇO/ Unidade
	[mm]	["]	[mm]	["]	DIMENSÕES	Nº		
	115	4,5	20/22,23	20/ 7/8	2,0x7x32	9	PROFISSIONAL	23,00
	230	9	20/22,23	20/ 7/8	2,5x7x40	16	PROFISSIONAL	56,00

DISCOS DIAMANTADOS - LASER - SEGMENTADOS - CLS 231

Aplicação: Betão.

 <p>CLS 231***</p>	TAMANHO (Ø)		FURO		SEGMENTOS		QUALIDADE	PREÇO/ Unidade
	[mm]	["]	[mm]	["]	DIMENSÕES	Nº		
	230	9	22,23/25,4	7/8/1/1 1/5/2	2,6x8	18	PROFISSIONAL	51,00

DISCOS ABRASIVOS PARA CORTAR E REBARBAR





APLICAÇÃO	DIMENSÕES [mm]	VELOCIDADE MÁXIMA [rpm]		PREÇO
CORTAR FERRO	115 x 3 x 22	13000	50	110,00
	125 x 3 x 22	12000	50	120,00
	180 x 3,2 x 22	8500	25	170,00
	230 x 3,2 x 22	6600	25	240,00
CORTAR PEDRA	115 x 3 x 22	13000	50	120,00
	125 x 3 x 22	12000	50	130,00
	180 x 3,2 x 22	8500	25	190,00
	230 x 3,2 x 22	6600	25	260,00
CORTAR INOX	115 x 1,0 x 22	13000	50	122,00
	115 x 1,6 x 22	13000	50	122,00
	125 x 1 x 22	12000	50	128,00
	125 x 1,6 x 22	12000	50	128,00
	180 x 1,6 x 22	8500	25	205,00
	230 x 2 x 22	6600	25	255,00
REBARBAR FERRO	115 x 6 x 22	13000	50	147,00
	125 x 6 x 22	12000	50	170,00
	180 x 7 x 22	8500	25	240,00
	230 x 6,4 x 22	6600	25	390,00

DISCOS LAMELARES

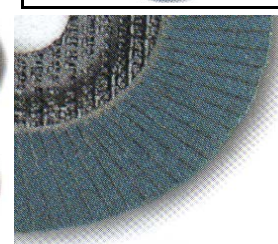

- Lamelas em tela de Zircônio - adequada para **aço inox**;
- Trabalha eficazmente sobre ferro, plástico, alumínio e metais em geral;
- Suporte em fibra de vidro - permite o desgaste e um excelente acabamento sem danificar a peça a trabalhar - o suporte degrada-se em simultâneo com as lamelas abrasivas.



DIMENSÕES [mm]	TAMANHO DO GRÃO	VELOCIDADE MÁXIMA [rpm]		PREÇO
115 x 22	40	13 300	10	290,00
178 x 22		8 600	10	1 100,00
115 x 22	60	13 300	10	290,00
178 x 22		8 600	10	1 100,00
115 x 22	80	13 300	10	290,00
178 x 22		8 600	10	1 100,00
115 x 22	120	13 300	10	290,00
178 x 22		8 600	10	1 100,00

RODAS LAMELARES COM ESPIGA

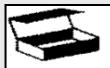

- Lamelas em tela de Corindo;
- Utilizado no polimento de aços normais e metais não ferrosos;
- Para trabalhar com máquinas portáteis (berbequim);
- Aplica-se no acabamento de peças de pequenas dimensões e de difícil acesso.

DIMENSÕES [mm]	TAMANHO DO GRÃO	VELOCIDADE MÁXIMA [rpm]		PREÇO
30 x 15	60	-	25	251,00
40 x 20		-	25	274,00
50 x 20		-	25	336,00
60 x 30		-	25	424,00
80 x 30		-	25	567,00
80 x 50		-	25	734,00
30 x 15	80	-	25	258,00
40 x 20		-	25	284,00
50 x 20		-	25	346,00
60 x 30		-	25	453,00
80 x 30		-	25	603,00
80 x 50		-	25	770,00

**DISCOS ABRASIVOS
PARA CORTAR E REBARBAR
- STAYER -**



APLICAÇÃO	DIMENSÕES [mm]	VELOCIDADE MÁXIMA [rpm]		PREÇO
CORTAR FERRO 	115 x 3 x 22	13300	25	91,00
	125 x 3 x 22	12230	25	99,00
	180 x 3 x 22	8490	25	136,00
	230 x 3 x 22	6650	25	195,00
CORTAR PEDRA 	115 x 1 x 22	13300	25	110,00
	115 x 3 x 22	13300	25	99,00
	230 x 1,9 x 22	6650	25	260,00
	230 x 3 x 22	6650	25	208,00
EXTRAFINO CORTAR INOX 	115 x 1,0 x 22	13300	25	121,00
	115 x 1,6 x 22	13300	25	121,00
	125 x 1 x 22	12230	25	126,00
	125 x 1,6 x 22	12230	25	126,00
	180 x 1,6 x 22	8490	25	173,00
	230 x 1,9 x 22	6650	25	220,00
REBARBAR FERRO 	115 x 6,4 x 22	13300	25	124,00
	125 x 6,4 x 22	12230	25	136,00
	180 x 6,4 x 22	8490	25	195,00
	230 x 6,4 x 22	6650	25	314,00

**DISCOS LAMELARES
- STAYER -**





- Material abrasivo: - Zircônio - adequada para **aço inox**;
- Corindo - para ferro;
- Trabalha eficazmente sobre ferro, plástico, alumínio e metais em geral;
- Suporte em fibra de vidro - permite o desgaste e um excelente acabamento sem danificar a peça a trabalhar - o suporte degrada-se em simultâneo com as lamelas abrasivas.



ZIRCÔNIO:
Para INOX



CORINDO:
Para FERRO

APLICAÇÃO	DIMENSÕES [mm] (GRÃO)	VELOCIDADE MÁXIMA [rpm]		PREÇO
Zircônio: para INOX 	115x22 (Z40)	13300	25	270,00
	115x22 (Z60)	13300	25	270,00
	115x22 (Z80)	13300	25	270,00
	115x22 (Z120)	13300	25	270,00
Corindo: para FERRO 	115x22 (Z40)	13300	25	230,00
	115x22 (Z60)	13300	25	230,00
	115x22 (Z80)	13300	25	230,00
	115x22 (Z120)	13300	25	230,00

ESCOVAS ABRASIVAS
- PARAFAST -







ESCOVA TAÇA DE FIOS ENTRANÇADOS



PRODUTO	MATERIAL	Ø [mm]	FURO	Ø FIO [mm]	VELOCIDADE MÁXIMA [rpm]		PREÇO
  	AÇO	75	M14	0,5	12500	5	7,57
		90	M14	0,5	8500	5	11,58
		100	M14	0,5	8500	5	14,78
	INOX	75	M14	0,5	12500	5	11,31
		90	M14	0,5	8500	5	17,49

ESCOVA TAÇA DE FIOS ONDULADOS



PRODUTO	MATERIAL	Ø [mm]	FURO	Ø FIO [mm]	VELOCIDADE MÁXIMA [rpm]		PREÇO
   	AÇO	80	M14	0,3	12500	5	6,17
		100	M14	0,3	8500	5	9,45
	INOX	80	M14	0,3	8500	5	9,18
		100	M14	0,3	8500	5	14,10
	LATÃO	75	M14	0,3	12500	5	15,20
		100	M14	0,3	8500	5	25,40
		125	M14	0,3	6500	5	36,33

ESCOVA TAÇA DE NYLON ABRASIVO





PRODUTO	MATERIAL	Ø [mm]	FURO	Ø FIO [mm]	VELOCIDADE MÁXIMA [rpm]		PREÇO
 	NYLON	75	M14	1,2	12500	5	16,97
		100	M14	1,2	8500	5	25,16
		125	M14	1,2	6500	5	33,28

ESCOVAS ABRASIVAS
- PARAFAST -





ESCOVA CÓNICA DE FIOS ENTRANÇADOS



PRODUTO	MATERIAL	Ø [mm]	FURO	Ø FIO [mm]	VELOCIDADE MÁXIMA [rpm]		PREÇO
	AÇO	100	M14	0,5	12500	5	7,57



ESCOVA CÓNICA DE FIOS ONDULADOS



PRODUTO	MATERIAL	Ø [mm]	FURO	Ø FIO [mm]	VELOCIDADE MÁXIMA [rpm]		PREÇO
	AÇO	90	M14	0,3	12500	5	6,90
	LATÃO	100	M14	0,3	12500	5	14,35
		115	M14	0,3	12500	5	18,20



ESCOVA CIRCULAR DE FIOS ENTRANÇADOS



PRODUTO	MATERIAL	Ø [mm]	FURO	Ø FIO [mm]	VELOCIDADE MÁXIMA [rpm]		PREÇO
	AÇO	115	M14	0,5	12500	5	11,35
		125	M14	0,5	12500	5	13,92
		178	M14	0,5	9000	5	17,64

ESCOVA CIRCULAR DE FIOS ENTRANÇADOS







PRODUTO	MATERIAL	Ø [mm]	FURO	Ø FIO [mm]	VELOCIDADE MÁXIMA [rpm]		PREÇO
	AÇO	115	22,2	0,5	12500	5	9,37
		125	22,2	0,5	12500	5	11,58
	INOX	115	22,2	0,5	12500	10	14,10

**ESCOVAS ABRASIVAS
- PARAFAST -**





ESCOVA CIRCULAR DE FIOS ONDULADOS



PRODUTO	MATERIAL	Ø [mm]	FURO	Ø FIO [mm]	VELOCIDADE MÁXIMA [rpm]		PREÇO
  	AÇO	125	12,7	0,3	8500	5	11,91
		150	32 mm + Set	0,3	6000	5	13,33
		200	32 mm + Set	0,3	6000	5	17,60
	LATÃO	150	32 mm + Set	0,3	6000	5	36,33
		200	32 mm + Set	0,3	4500	5	51,77

ESCOVA CIRCULAR DE NYLON ABRASIVO



PRODUTO	MATERIAL	Ø [mm]	FURO	Ø FIO [mm]	VELOCIDADE MÁXIMA [rpm]		PREÇO
 	NYLON	100	12,7	1,2	4500	12	11,91
		125	12,7	1,2	4500	12	21,25

ESCOVA CIRCULAR DE POLÍMERO ABRASIVO



PRODUTO	MATERIAL	Ø [mm]	FURO	VELOCIDADE MÁXIMA [rpm]		PREÇO
 	NYLON + CARBONETO DE SILÍCIO	115	22,2	8500	5	12,08
		125	22,2	8500	5	14,97

ESCOVA CIRCULAR DE POLIR EM ALGODÃO



PRODUTO	MATERIAL	Ø [mm]	FURO	VELOCIDADE MÁXIMA [rpm]		PREÇO
 	ALGODÃO	100	12,7 mm	4500	12	4,94
		150	12,7 mm	4500	5	8,55
		200	12,7 mm	4500	5	13,86

ESCOVAS ABRASIVAS
- PARAFAST -



ESCOVA PINCEL DE FIOS ENTRANÇADOS



PRODUTO	MATERIAL	Ø [mm]	Ø HASTE [mm]	Ø FIO [mm]	VELOCIDADE MÁXIMA [rpm]		PREÇO
	AÇO	19	6	0,5	20000	20	4,84
	INOX	19	6	0,5	20000	20	7,66

ESCOVA PINCEL DE FIOS ONDULADOS



PRODUTO	MATERIAL	Ø [mm]	Ø HASTE [mm]	Ø FIO [mm]	VELOCIDADE MÁXIMA [rpm]		PREÇO
	AÇO	22	6	0,3	20000	20	2,59
		28	6	0,3	20000	20	3,50
	LATÃO	25	6	0,3	4500	20	5,80
		28	6	0,3	4500	20	7,63

ESCOVA PINCEL DE NYLON ABRASIVO



PRODUTO	MATERIAL	Ø [mm]	Ø HASTE [mm]	Ø FIO [mm]	VELOCIDADE MÁXIMA [rpm]		PREÇO
	NYLON	17	6	1,2	4500	12	4,40
		24	6	1,2	4500	12	5,19

ESCOVAS ABRASIVAS
- PARAFAST -



ESCOVA TAÇA DE ESPIGA DE FIOS ONDULADOS



PRODUTO	MATERIAL	Ø [mm]	Ø HASTE [mm]	Ø FIO [mm]	VELOCIDADE MÁXIMA [rpm]		PREÇO
	AÇO	50	6	0,3	4500	10	3,28
		75	6	0,3	4500	12	4,19
	LATÃO	50	6	0,3	4500	12	7,03
		75	6	0,3	4500	12	8,85

ESCOVA TAÇA DE ESPIGA DE NYLON ABRASIVO



PRODUTO	MATERIAL	Ø [mm]	Ø HASTE [mm]	Ø FIO [mm]	VELOCIDADE MÁXIMA [rpm]		PREÇO
	NYLON	50	6	1,2	4500	12	5,56
		75	6	1,2	4500	12	7,21

ESCOVA CIRCULAR DE ESPIGA DE FIOS ENTRANÇADOS



PRODUTO	MATERIAL	Ø [mm]	Ø HASTE [mm]	Ø FIO [mm]	VELOCIDADE MÁXIMA [rpm]		PREÇO
	AÇO	75	6	0,5	12500	10	6,44

**ESCOVAS ABRASIVAS
- PARAFAST -**



ESCOVA CIRCULAR DE ESPIGA DE FIOS ONDULADOS



PRODUTO	MATERIAL	Ø [mm]	Ø HASTE [mm]	Ø FIO [mm]	VELOCIDADE MÁXIMA [rpm]		PREÇO
	AÇO	50	6	0,3	4500	10	2,55
		75	6	0,3	4500	10	3,21
		100	6	0,3	4500	10	4,07
	INOX	100	6	0,3	4500	10	5,80
	LATÃO	50	6	0,3	4500	12	6,41
		75	6	0,3	4500	12	7,03
		100	6	0,3	4500	12	8,43

ESCOVA CIRCULAR DE ESPIGA EM NYLON ABRASIVO



PRODUTO	MATERIAL	Ø [mm]	Ø HASTE [mm]	Ø FIO [mm]	VELOCIDADE MÁXIMA [rpm]		PREÇO
	NYLON	50	6	1,2	4500	12	4,76
		75	6	1,2	4500	12	5,80
		100	6	1,2	4500	12	7,21

ESCOVA CIRCULAR DE ESPIGA EM POLÍMERO ABRASIVO



PRODUTO	MATERIAL	Ø [mm]	Ø HASTE [mm]	VELOCIDADE MÁXIMA [rpm]		PREÇO
	NYLON + CARBONETO DE SILÍCIO	55	6	4500	12	4,94
		65	6	4500	12	5,61
		75	6	4500	12	6,78

**ESCOVAS ABRASIVAS
- PARAFAST -**



ESCOVA CIRCULAR DE ESPIGA DE POLIR EM ALGODÃO



PRODUTO	MATERIAL	Ø [mm]	Ø HASTE [mm]	VELOCIDADE MÁXIMA [rpm]		PREÇO
	ALGODÃO	50	6	4500	12	4,40
		75	6	4500	12	5,01
		100	6	4500	12	5,61

ESCOVA CIRCULAR DE ESPIGA EM AÇO ENCAPSULADO



PRODUTO	MATERIAL	Ø [mm]	Ø HASTE [mm]	Ø FIO [mm]	VELOCIDADE MÁXIMA [rpm]		PREÇO
	AÇO	60	6	0,2	4500	12	11,91
		75	6	0,2	4500	12	11,91

ESCOVA MANUAL

PRODUTO	MATERIAL			Ø FIO [mm]			PREÇO
	AÇO			0,3		12	1,79
	INOX			0,3		12	3,12
	AÇO LATONADO			0,3		12	4,16
	NYLON			1,2		12	10,26

KITS DE ANÉIS DE REDUÇÃO

PRODUTO	MEDIDAS		PREÇO
	12 - 16 - 20 - 22 - 25	10	1,12
	1" - 7/8 - 3/4 - 5/8 - 1/2	10	

GAMA COMPLETA DE LIXAS TRABALHOS À MÃO E COM MÁQUINA



A Sociedade Europeia de Abrasivos, **S.E.A.**, fabrica abrasivos com o mais elevado desempenho numa gama de produtos técnicos que distribui a partir de França pelo mundo inteiro. A sua experiência e know-how permitiu-lhe desenvolver, nestes últimos cem anos, a gama de abrasivos mais detalhada do mercado, com produtos tais como abrasivos para trabalho manual ou para máquinas eletroportáteis.





TABELA DE COMPATIBILIDADES

CONSUMÍVEL	DIMENSÕES	FURAÇÃO	MARCA	REFERÊNCIAS
	115 X 230 mm	14 Furos em oval	AEG BOSCH PERLES FEIN	VS280 / VSE280 / VS250 / VSE250 / VS14 / VSE20 GSS28 / GSS28A / GSS280A / GSS280AE VK745 / VK743 MS641
	115 x 230 mm	2 x 5 Furos	BOSCH FESTO MAKITA	PSS300AE RS100 / RS100C / RS200 9046 / BO4900V / BO4901
	Ø 125 mm	8 Furos sobre Ø 90 mm + 1 Furo	FESTOOL METABO	ETS 125 EQ / ETS 125 EQ-Plus / ETS 125 Q / LEX 2 125/3 LEX 2 125/7 / ROTEX RO 125 FEQ-Plus SXE 325 Intec / SXE 425 Turbo Tec
	Ø 125 mm	8 Furos sobre Ø 65 mm + 1 Furo	FESTOOL METABO	ETS125 EQ / ETS 125 EQ-PLUS / ETS 125 Q / LEX 2 125/3 LEX 2 125/7 / ROTEX RO 125 FEQ-PLUS SXE 325 Intec / SXE 425 Turbo tec
	Ø 115 mm	8 Furos sobre Ø 65 mm	BOSCH FESTOOL	PEX 11A / PEX 11AE / PEX 115 RAS 115.04 E / RAS 115.04 E-Set
	Ø 125 mm	8 Furos sobre Ø 65 mm	BOSCH FESTOOL FLEX MAKITA METABO	GEX 125 A / GEX 125 AC / GEX 125 1-AE / PEX 12 A / PEX 12 AE / PEX 125 A-1 / PEX 125 AE / PEX 220 A / PEX 270 A / PEX 270 AE / PEX 300 A / PEX 300 E / PEX 400 AE ES 125 / ES 125 E ORE 125-2 / XS 712 A / XS 713 BO5010 / BO5021K / BO5030 / BO5031K / BO5041KX1 FSX 200 Intec / SXE 125 / SXE 425
	Ø 150 mm	8 Furos sobre Ø 120 mm + 1 Furo	MAKITA FESTOOL	BO6030 / BO6040 ET 2 E / ETS 150/3 E-C / ETS 150/3 EQ / ETS 150/3 EQ-Plus / ETS 150/5 E-C / ETS 150/5 EQ / ETS 150/5 EQ-Plus / ROTEX RO 150 E / ROTEX RO 150 E-Plus / ROTEX RO 150 FE/ ROTEX RO 150 FEQ / ROTEX RO 150 FEQ-Plus / WTS 150/7 E-Plus
	93x93x93 mm	6 furos em círculo	BOSCH MAKITA METABO B&D	PDA100 / PDA210E / PDA180 / PDA180E / PDA240E / GD280E / PDA10-92 BO4561 DSE130 / DSE170 / DSE180 KA510
	105x105x105 mm	6 furos em círculo	KRESS AEG	93x93x93 mm 6 furos em triângulo FESTO DELTEX
	100x150 mm 7 furos	FESTO DS400		100x165 mm 8 furos B&D KA220 Multi / KA220E Multi / KA210E
	93x150 mm 11 furos	BOSCH PSM80A		

FOLHAS DE LIXA



230 x 280 mm		Trabalhos em madeira e pintura em metal			Corindo
  <p>Marceneiro</p>	Caraterísticas	Grão	Código		PREÇO
	<ul style="list-style-type: none"> • Papel acabamento; • Aglutinação por colagem dupla; • Grão em óxido de alumínio castanho; • Estrutura semi aberta; • Deposição eletrostática. 	220	011640	50	27,55
		180	011641	50	27,55
		150	011642	50	27,55
		120	011643	50	27,55
		100	011644	50	27,55
		80	011645	50	33,24
		60	011647	50	38,76
40		011649	50	49,80	
230 x 280 mm		Trabalhos em madeira e pintura em metal			Corindo
  <p>Marcenaria e Pintura (uso intensivo)</p>	Caraterísticas	Grão	Código		PREÇO
	<ul style="list-style-type: none"> • Papel C (120g); • Aglutinação por colagem dupla; • Grão em óxido de alumínio branco; • Estrutura semi aberta; • Deposição eletrostática. 	220	330240	50	33,24
		180	330241	50	33,24
		150	330242	50	33,24
		120	330243	50	33,24
		100	330244	50	33,24
		80	330245	50	36,00
		60	330247	50	39,00
40		330249	50	40,25	
230 x 280 mm		Trabalhos em madeira			SILEX
  <p>Marceneiro</p>	Caraterísticas	Grão	Código		PREÇO
	<ul style="list-style-type: none"> • Papel verde (110g); • Aglutinação por cola de origem animal com cargas (giz) para reforço da resistência mecânica; • Grão em SILEX; • Deposição eletrostática. 	150	001920	50	21,81
		120	001910	50	22,25
		100	001916	50	26,56
		80	001915	50	27,36
		60	001947	50	30,34
40		001914	50	32,52	
F100® 230 x 280 mm		VS+® Trabalhos em carrocerias e pintura industrial			Extra suave
  <p>Anti incrustante Trabalhos delicados (uso profissional)</p>	Caraterísticas	Grão	Código		PREÇO
	<ul style="list-style-type: none"> • Papel anti incrustações; • Estearato de zinco; • Aglutinação por resina; • Grão em carboneto de silício; • Estrutura semi aberta; • Deposição eletrostática. 	220	308040	50	39,25
		180	308041	50	41,35
		150	308042	50	44,44
		120	308043	50	46,59
		100	308044	50	52,78
		80	308045	50	53,71
		60	308047	50	57,96
40		308049	50	65,14	
230 x 280 mm		Trabalhos em carrocerias e pintura industrial			Lixa de água
  <p>Lixa de água</p>	Caraterísticas	Grão	Código		PREÇO
	<ul style="list-style-type: none"> • Papel latex; • Aglutinação por resina impermeável; • Grão em carboneto de silício; • Estrutura fechada; • Deposição eletrostática. 	1200	301630	50	38,76
		1000	301631	50	38,76
		800	301632	50	38,76
		600	301633	50	38,76
		500	301634	50	38,76
		400	301635	50	40,80
		360	301636	50	40,80
		320	301637	50	40,80
		280	301638	50	40,80
		240	301639	50	40,80
		220	301640	50	40,80
		180	301641	50	40,80
		150	301642	50	45,21
120		301643	50	51,01	
100	301644	50	55,87		
80	301645	50	58,19		
60	301647	50	63,98		



FOLHAS DE LIXA AUTOADERENTES



73 x 123 mm

Trabalhos em madeira e pintura em metal



Corindo

  Marceneiro	Caraterística	Grão	Código		PREÇO
	<ul style="list-style-type: none"> • Papel E (220g); • Aglutinação por resina dupla; • Grão em óxido de alumínio castanho; • Deposição eletrostática. 	320	311437	100	19,32
		240	311439	100	30,36
		220	311440	100	30,36
		180	311441	100	30,36
		150	311442	100	30,36
		120	311443	100	30,36
		100	311444	100	30,36
		80	311445	100	30,36
		60	311447	100	30,36
40		311449	100	30,36	

73 x 123 mm

Trabalhos em madeira e pintura em metal



Corindo

  Marcenaria e Pintura (uso intensivo)	Caraterística	Grão	Código		PREÇO
	<ul style="list-style-type: none"> • Papel E (220g); • Aglutinação por resina dupla; • Grão em óxido de alumínio branco; • Deposição eletrostática. 	240	311339	100	30,36
		180	311341	100	30,36
		150	311342	100	30,36
		120	311343	100	30,36
		100	311344	100	30,36
		80	311345	100	30,36
		60	311347	100	30,36
		40	311349	100	30,36

73 x 123 mm

VS+® Trabalhos em carrocerias e pintura industrial



Corindo
Anti incrustação

  Anti incrustante Trabalhos delicados (uso profissional)	Caraterística	Grão	Código		PREÇO
	<ul style="list-style-type: none"> • Papel E (220g); • Aglutinação por resina dupla; • Grão em óxido de alumínio branco; • Deposição eletrostática; • Estearato. 	220	308440	4x25	36,71
		180	308441	4x25	36,71
		150	308442	4x25	36,71
		120	308443	4x25	36,71
		100	308444	4x25	36,71
		80	308445	4x25	36,71
		60	308447	4x25	36,71
		40	308449	4x25	36,71

120 x 70 x 35 mm

Trabalhos em madeira e pintura em metal

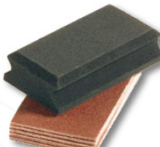
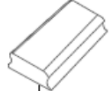
Corindo

   Bloco de Lixagem	Caraterística	Grão	Código		PREÇO/Unidade
	• Taco para folhas de lixa autoaderentes	Neutro	630399	10	4,47



ROLOS DE LIXA



120 mm x 50 m

Trabalhos em madeira e pintura em metal

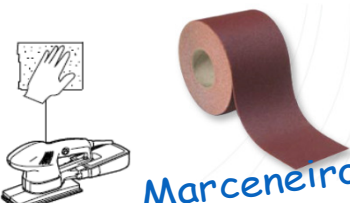

Papel Corindo

 <p>Marceneiro</p>	Caraterísticas	Grão	Código		PREÇO/Unidade
	<ul style="list-style-type: none"> Papel E(220 g); Aglutinação por resina dupla; Grão em óxido de alumínio castanho; Estrutura semi aberta; Deposição eletrostática. 	120	330543	1	52,77
		100	330544	1	52,77
		80	330545	1	58,65
		60	330547	1	67,65

120 mm x 25 m

Trabalhos em madeira e pintura em metal



Papel Corindo

 <p>Marcenaria e Pintura (uso intensivo)</p>	Caraterísticas	Grão	Código		PREÇO/Unidade
	<ul style="list-style-type: none"> Papel E(220 g); Aglutinação por resina; Grão em óxido de alumínio branco; Estrutura semi aberta; Deposição eletrostática. 	120	344243	1	24,67
		100	344244	1	24,67
		80	344245	1	27,63
		60	344247	1	29,64

F100® 120 mm x 50 m

VS+® Trabalhos em carrocerias e pintura industrial

Papel Flexível Anti incrustação

 <p>Anti incrustante Trabalhos delicados (uso profissional)</p>	Caraterísticas	Grão	Código		PREÇO/Unidade
	<ul style="list-style-type: none"> Papel C; Aglutinação por resina dupla; Grão em óxido de alumínio; Estrutura semi aberta; Deposição eletrostática. 	150	308242	1	60,18
		120	308243	1	60,18
		100	308244	1	60,18
		80	308245	1	61,24
		60	308247	1	66,65
		40	308249	1	74,19



FOLHAS DE LIXA AUTOADERENTES PARA LIXADORAS VIBRATÓRIAS COM ASPIRAÇÃO



PRO® 115 x 228 mm

Trabalhos em madeira e pintura em metal

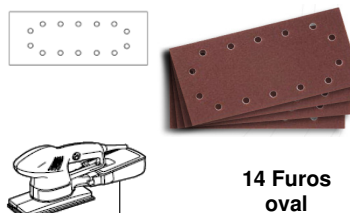

Corindo

 <p>14 Furos oval</p>	Caraterísticas	Grão	Código		PREÇO
	<ul style="list-style-type: none"> Papel E (220g); Aglutinação por resina dupla; Grão em óxido de alumínio castanho; Deposição eletrostática. 	120	313743	100	124,76
		80	313745	100	124,76
		60	313747	100	124,76
		40	313749	100	124,76

PRO® 115 x 228 mm

Trabalhos em madeira e pintura em metal

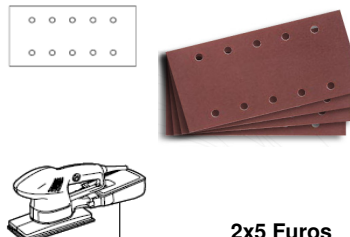
Corindo

 <p>2x5 Furos</p>	Caraterísticas	Grão	Código		PREÇO
	<ul style="list-style-type: none"> Papel E (220g); Aglutinação por resina dupla; Grão em óxido de alumínio castanho; Deposição eletrostática. 	180	312441	100	124,76
		120	312443	100	124,76
		100	312444	100	124,76
		80	312445	100	124,76
		60	312447	100	124,76
40	312449	100	124,76		

DISCOS DE LIXA AUTOADERENTES



Ø 125 mm	Trabalhos em madeira e pintura em metal	Corindo		
<div style="text-align: center;"> <p>8+1 Furos /90 mm</p> </div>	Caraterísticas	Grão	Código	
	<ul style="list-style-type: none"> • Papel E (220g); • Aglutinação por resina dupla; • Grão em óxido de alumínio castanho; • Deposição eletrostática. 	120	336843	50
		100	336844	50
		80	336845	50
		60	336847	50
		40	336849	50
PREÇO			65,15	
			65,15	
			65,15	
			65,15	
			72,00	
Ø 125 mm	Trabalhos em madeira e pintura em metal	Corindo		
<div style="text-align: center;"> <p>8+1 Furos /65 mm</p> </div>	Caraterísticas	Grão	Código	
	<ul style="list-style-type: none"> • Papel E (220g); • Aglutinação por resina dupla; • Grão em óxido de alumínio castanho; • Deposição eletrostática. 	120	336943	50
		100	336944	50
		80	336945	50
		60	336947	50
		40	336949	50
PREÇO			65,15	
			65,15	
			65,15	
			65,15	
			72,00	
Ø 115 mm	Trabalhos em madeira e pintura em metal	Corindo		
<div style="text-align: center;"> <p>8 Furos</p> </div>	Caraterísticas	Grão	Código	
	<ul style="list-style-type: none"> • Papel E (220g); • Aglutinação por resina dupla; • Grão em óxido de alumínio castanho; • Deposição eletrostática. 	240	338539	50
		180	338541	50
		150	338542	50
		120	338543	50
		100	338544	50
		80	338545	50
		60	338547	50
40	338549	50		
PREÇO			61,72	
			61,72	
			61,72	
			61,72	
			61,72	
			61,72	
			70,86	
Ø 125 mm	Trabalhos em madeira e pintura em metal	Corindo		
<div style="text-align: center;"> <p>8 Furos</p> </div>	Caraterísticas	Grão	Código	
	<ul style="list-style-type: none"> • Papel E (220g); • Aglutinação por resina dupla; • Grão em óxido de alumínio castanho; • Deposição eletrostática. 	320	338637	50
		240	338639	50
		180	338641	50
		150	338642	50
		120	338643	50
		100	338644	50
		80	338645	50
		60	338647	50
		40	338649	50
PREÇO			65,15	
			65,15	
			65,15	
			65,15	
			65,15	
			65,15	
			72,00	
Ø 150 mm	Trabalhos em madeira e pintura em metal	Corindo		
<div style="text-align: center;"> <p>8+1 Furos</p> </div>	Caraterísticas	Grão	Código	
	<ul style="list-style-type: none"> • Papel E (220g); • Aglutinação por resina dupla; • Grão em óxido de alumínio castanho; • Deposição eletrostática. 	180	340541	50
		150	340542	50
		120	340543	50
		60	340547	50
		40	340549	50
PREÇO			72,00	
			72,00	
			72,00	
			78,86	
			86,86	
Ø 115/125/150 mm	Prato para discos auto aderentes	Autoaderentes		
	Caraterísticas	Ø	Código	
	<ul style="list-style-type: none"> • Autoaderente 	115	511164	1
		125	511165	1
		150	511166	1
PREÇO/Unidade			15,66	
			17,14	
			28,69	





DELTA DE LIXA AUTOADERENTES



93 x 93 x 93 mm

Trabalhos em madeira e pintura em metal





Corindo

   6 Furos triângulo	Caraterísticas	Grão	Código		PREÇO
	<ul style="list-style-type: none"> • Papel E (220g); • Aglutinação por resina dupla; • Grão em óxido de alumínio castanho; • Deposição eletrostática. 	120	341943	100	50,29
		100	341944	100	50,29
		80	341945	100	50,29
		60	341947	100	50,29
40		341949	100	50,29	

93 x 93 x 93 mm

Trabalhos em madeira e pintura em metal





Corindo

   6 Furos círculo	Caraterísticas	Grão	Código		PREÇO
	<ul style="list-style-type: none"> • Papel E (220g); • Aglutinação por resina dupla; • Grão em óxido de alumínio castanho; • Deposição eletrostática. 	180	342541	100	50,29
		120	342543	100	50,29
		100	342544	100	50,29
		80	342545	100	50,29
		60	342547	100	50,29
40		342549	100	50,29	

PRO® 105 x 105 x 105 mm

Trabalhos em madeira e pintura em metal





Corindo

   6 Furos círculo	Caraterísticas	Grão	Código		PREÇO
	<ul style="list-style-type: none"> • Papel E (220g); • Aglutinação por resina dupla; • Grão em óxido de alumínio castanho; • Deposição eletrostática. 	120	342443	100	57,15
		80	342445	100	57,15
		60	342447	100	57,15
40		342449	100	57,15	

PRO® 100 x 147 mm

Trabalhos em madeira e pintura em metal





Corindo

   7 Furos	Caraterísticas	Grão	Código		PREÇO
	<ul style="list-style-type: none"> • Papel E (220g); • Aglutinação por resina dupla; • Grão em óxido de alumínio castanho; • Deposição eletrostática. 	120	338243	100	84,58
		100	338244	100	84,58
		80	338245	100	84,58
		60	338247	100	84,58
40		338249	100	84,58	

PRO® 100 x 165 mm

Trabalhos em madeira e pintura em metal



Corindo

   8 Furos	Caraterísticas	Grão	Código		PREÇO
	<ul style="list-style-type: none"> • Papel E (220g); • Aglutinação por resina dupla; • Grão em óxido de alumínio castanho; • Deposição eletrostática. 	180	343541	100	84,58
		120	343543	100	84,58
		100	343544	100	84,58
		80	343545	100	84,58
		60	343547	100	84,58
40		343549	100	84,58	

PRO® 100 x 150 mm

Trabalhos em madeira e pintura em metal

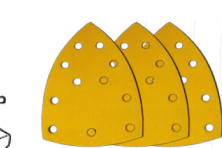
Corindo

   11 Furos	Caraterísticas	Grão	Código		PREÇO
	<ul style="list-style-type: none"> • Papel E (220g); • Aglutinação por resina dupla; • Grão em óxido de alumínio branco; • Deposição eletrostática. 	120	328943	50	84,58
		80	328945	50	84,58
40		328949	50	84,58	

**BROCAS PARA PEDRA / BETÃO
DIN 8039 - ISO 5468**

ECEF

STANDARD





DIN 8039
ISO 5468



ROTOPERCUSSÃO



PROFISSIONAL





DIN 8039
ISO 5468



ROTO-
PERCUSSÃO

- Corpo fresado com canais em "U".
- Pastilha em metal duro soldada ao corpo da broca por brasagem a 1100 °C.
- Resistente a fortes percussões.



Diâmetro Ø		Comprimento total L		STANDARD		PROFISSIONAL	
[mm]	["]	[mm]	["]	SCUDO	1 Unid.	SUPER	1 Unid.
				CÓDIGO	PREÇO	CÓDIGO	PREÇO
3	1/8"	60	2 5/8"	MSL03	0,31	240030	0,92
4	5/32"	75	3 1/8"	MSL04	0,35	240040	1,00
5	3/16"	85	3 1/2"	MSL05	0,43	240050	1,07
6	15/64"	100	4"	MSL06	0,49	240060	1,21
6,5	1/4"	100	4"	MSL65	0,53		
7	9/32"	100	4"	MSL07	0,55	240070	1,40
8	5/16"	120	4 3/4"	MSL08	0,79	240080	1,54
9	11/32"	120	4 3/4"	MSL09	0,89	240090	1,85
10	3/8"	120	4 3/4"	MSL10	0,98	240100	2,12
11	7/16"	120	4 3/4"	MSL11	1,35	240110	2,79
12	15/32"	150	6"	MSL12	1,43	240120	3,09
13	1/2"	150	6"	MSL13	1,56	240130	4,16
14	9/16"	150	6"	MSL14	1,77	240140	4,52
15	19/32"	150	6"	MSL15	2,06		
16	5/8"	150	6"			240160	5,31
18	11/16"	160	6 1/2"	MSL18	5,40	240180	9,15
20	3/4"	160	6 1/2"	MSL20	6,30	240200	11,22
22	7/8"	160	6 1/2"	MSL22	8,50		

BROCAS PARA MARTELOS SDS+

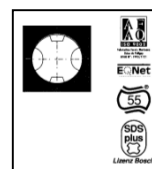
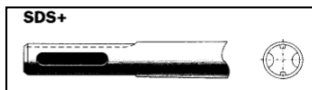

EMBALAGEM:
ESTOJO INDIVIDUAL

COMP. [mm]	110	160	210	260	310	410	610
DIÂM. [mm]	C. ÚTIL 50	C. ÚTIL 100	C. ÚTIL 150	C. ÚTIL 200	C. ÚTIL 250	C. ÚTIL 350	C. ÚTIL 550
4	438,00						
5	376,00	451,00					
5,5	397,00	462,00					
6	355,00	368,00	612,00	986,00	1.233,00		
6,5	416,00	491,00					
7	406,00	451,00	628,00				
8	376,00	389,00	532,00	782,00	1.053,00	1.966,00	
9		529,00	744,00				
10	403,00	481,00	685,00	806,00	1.098,00	1.850,00	
11		645,00	790,00	964,00			
12		591,00	843,00	1.053,00	1.386,00	1.850,00	2.952,00
13		975,00	1.093,00	1.187,00	1.485,00	2.055,00	
14		975,00	1.093,00	1.187,00	1.571,00	2.055,00	3.140,00
15		1.254,00	1.324,00	1.445,00	1.711,00	2.055,00	
16		1.233,00	1.300,00	1.418,00	1.711,00	2.055,00	3.602,00
18			1.829,00	1.987,00	2.487,00	2.987,00	4.332,00
19							
20			2.444,00	3.024,00	3.330,00	3.763,00	5.465,00
22			3.373,00	3.698,00	4.190,00	4.662,00	5.817,00
24			4.335,00	4.730,00	5.390,00	6.048,00	7.413,00
25			4.662,00	5.100,00	6.161,00	7.370,00	8.269,00

BROCAS PARA MARTELOS SDS+

hooster PLUS

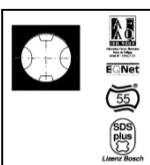

Placa:
-monobloco;
-ponta c/ pino de centragem;
-efeito de limpeza;
-3 aresta de corte.
Hélice:
-3 hélices.

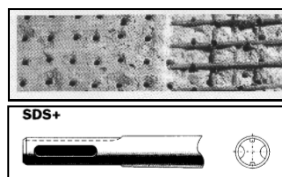

IDEAL PARA BETÃO ARMADO:
- Fura o ferro do betão (resiste ao contacto com as barras de armação do betão).

EMBALAGEM: ESTOJO INDIVIDUAL

COMP. [mm]	110	160	210	260	310	410	610
DIÂM. [mm]	C. ÚTIL 50	C. ÚTIL 100	C. ÚTIL 150	C. ÚTIL 200	C. ÚTIL 250	C. ÚTIL 350	C. ÚTIL 550
6	959,00	959,00	1.214,00				
8	1.141,00	1.187,00	1.241,00		1.601,00		
10	1.295,00	1.268,00	1.386,00		1.867,00		
12		1.426,00	1.571,00		2.106,00		
14		1.834,00	2.055,00		2.479,00		
16			2.447,00		2.535,00		
18			3.435,00		3.687,00		
20			4.595,00		4.939,00		

BROCAS PARA PEDRA / BETÃO SDS-PLUS COM 3 LÂMINAS MONOBLOCO "TRI-STAR"

ECEF



DIN 8035

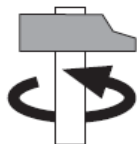

ROTO-PERCUSSÃO



Ø

IDEAL PARA BETÃO ARMADO



- Nova pastilha de Carboneto de Tungstênio com geometria triangular em forma de estrela, para uma furação mais rápida e furos perfeitamente concêntricos para uma melhor fixação. • • Ponta autocentrante, cabeça larga com efeito cinzel para um grande poder de corte.



- Corpo com 3 hélices para uma evacuação mais rápida dos detritos.



- Novo processo de acabamento por jato de areia que garante uma maior resistência à torção e à flexão e uma vida mais longa da ferramenta.
- A broca **TRI-STAR** garante **1500 furos** contra os cerca de 300 de uma broca normal.

TABELA DE EFICIÊNCIA

Betão	★★★★
Betão armado	★★★★
Pedra (dura)	★★★★
Granito	★★★
Pavimento de tijolo	★★★★
Gesso	★★★★
Tijolo	★★★★
Cerâmica	★★

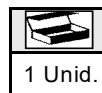

Ø [mm]	ECEF "TRI-STAR"			
	L1 [mm]	L2 [mm]	CÓDIGO	PREÇO
5	110	50	77005110	9,25
	160	100	77005160	9,56
6	110	50	77006110	9,25
	160	100	77006160	9,83
	210	150	77006210	12,49
	260	200	77006260	15,36
8	110	50	77008110	11,18
	160	100	77008160	11,32
	210	150	77008210	12,64
	260	200	77008260	15,11
	310	250	77008310	19,32
	460	400	77008460	23,99
10	110	50	77010110	12,66
	160	100	77010160	13,24
	210	150	77010210	15,71
	260	200	77010260	17,81
	310	250	77010310	19,54
	460	400	77010460	23,99
12	160	100	77012160	13,08
	210	150	77012210	14,51
	260	200	77012260	19,22
	310	250	77012310	22,77
	460	400	77012460	24,96
14	160	100	77014160	16,84
	210	150	77014210	18,40
	260	200	77014260	23,39
	310	250	77014310	27,36
	460	400	77014460	29,82
16	210	150	77016210	25,04
	310	250	77016310	29,26
	460	400	77016460	41,60
18	210	150	77018210	38,10
	310	250	77018310	43,90
20	210	150	77020210	57,20
	310	250	77020310	65,90

BROCAS PARA PEDRA / BETÃO SDS-PLUS

ECEF

ECEF
DUPLO CANAL





ROTO-PERCUSSÃO



- Dupla hélice de evacuação.
- Nova geometria da pastilha autocentrante.
- Pastilha soldada por brasagem a 1100 °C.



1 Unid.

ECEF
REX







ROTO-PERCUSSÃO



IDEAL PARA GRANITO



DIN 8035

- Corpo que alterna uma hélice larga e uma hélice estreita para uma transmissão de potência óptima e uma evacuação mais rápida dos detritos.
- Novo processamento por jacto de areia que garante uma melhor resistência à rotura e uma vida mais longa da ferramenta.
- Nova pastilha de carboneto de tungsténio com geometria em forma de cinzel, concebida para **uma furação mais rápida mesmo em cimento armado.**



1 Unid.

Ø x L [mm]	ECEF DUPLO CANAL		ECEF REX	
	CÓDIGO	PREÇO	CÓDIGO	PREÇO
4 x 110	99004110	2,05	4300401	4,51
4 x 160			4300411	6,87
5 x 110	99005110	2,13	4300501	4,06
5 x 160	99005160	2,37	4300511	5,15
5 x 210	99005210	3,06		
5,5 x 110			4300551	5,59
5,5 x 160			4300561	6,01
6 x 110	99006110	2,25	4300601	4,12
6 x 160	99006160	2,52	4300611	4,69
6 x 210	99006210	3,32	4310601	7,15
6 x 260			4310611	11,48
6 x 310	99006310	3,90		
6,5 x 110	99065110	2,33	4300641	4,76
6,5 x 160	99065160	2,65	4300661	5,93
7 x 110	99007110	2,43	4300711	4,90
7 x 160	99007160	2,67	4300701	5,55
8 x 110	99008110	2,48	4300801	4,86
8 x 160	99008160	2,83	4300811	5,36
8 x 210	99008210	3,70	4310801	6,99
8 x 260	99008260	3,94	4310811	7,81
8 x 310	99008310	5,31	4310821	11,27
8 x 450	99008450	7,91		
9 x 160	99009160	3,45	4300911	5,50
10 x 110	99010110	2,73	4301001	5,38
10 x 160	99010160	3,06	4301011	6,51
10 x 210	99010210	3,80	4311011	7,67
10 x 260	99010260	4,17	4311001	8,49
10 x 310	99010310	6,28	4311021	11,29
10 x 450	99010450	8,15		
10 x 460			4321011	16,79
10 x 600	99010600	11,83	4321021	23,53
11 x 160	99011160	3,38		
12 x 160	99012160	3,40	4301201	8,05
12 x 210	99012210	4,31	4311211	9,53
12 x 260	99012260	4,70	4311201	12,02
12 x 310	99012310	7,42	4311221	12,98
12 x 450	99012450	9,14	4321211	19,07
12 x 600	99012600	12,79	4321221	23,40
13 x 160			4301311	8,83
13 x 250	99013260	6,33	4311301	13,25
13 x 300			4311321	15,57
14 x 160	99014160	4,31	4301401	10,83
14 x 210	99014210	5,16	4311411	11,73
14 x 250			4311401	12,74
14 x 260	99014260	5,66		
14 x 300			4311421	15,58
14 x 310	99014310	7,79		
14 x 450	99014450	10,88	4321411	23,10
14 x 600	99014600	14,89	4321421	29,46
15 x 160			4301501	11,90
15 x 210			4311511	15,02
15 x 250			4311501	16,51
16 x 160	99016160	4,81	4301601	13,06
16 x 210	99016210	6,04	4311601	14,52
16 x 250			4311611	17,46
16 x 260	99016260	6,54		
16 x 300			4311621	19,45
16 x 310	99016310	8,38		
16 x 450	99016450	11,79	4321611	24,64
16 x 600	99016600	15,67	4321621	31,36
18 x 200			4311801	18,34
18 x 260	99018260	8,66		
18 x 300			4311821	24,53
18 x 310	99018310	9,64		
18 x 450	99018450	13,55	4321811	31,41
18 x 600	99018600	16,66	4321821	38,12
19 x 200			4311910	22,11
19 x 450			4321911	35,74
20 x 200			4312001	23,18
20 x 210	99020210	9,38		
20 x 260	99020260	10,26		
20 x 300			4312021	27,40
20 x 310	99020310	11,34		
20 x 450	99020450	15,24	4322011	37,79
20 x 600	99020600	20,22	4322021	54,81
22 x 250			4312201	28,75
22 x 260	99022260	11,83		
22 x 310	99022310	13,32		
22 x 450	99022450	18,08	4322211	45,77
22 x 600	99022600	22,94	4322221	68,51
24 x 250			4312401	38,95
24 x 260	99024260	15,05		
24 x 450	99024450	19,87	4322411	49,80
24 x 600	99024600	26,81		
25 x 250			4312501	41,87
25 x 260	99025260	15,67		
25 x 450	99025450	21,16	4322511	51,09
25 x 600	99025600	28,39		
26 x 250			4312601	49,60
26 x 450			4322611	62,45

BROCAS PARA MARTELOS SDS MAX

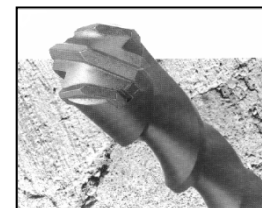
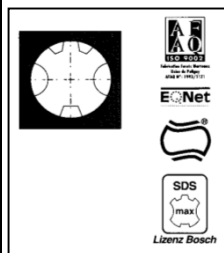

SDS MAX



**CABEÇA:
- 3 PASTILHAS
- 6 FACES DE CORTE**

Embalagem: estojo individual

DIÂMETRO (mm)	COMPRIMENTO (mm)			
	340	540	690	920
	COMPRIM. ÚTIL=200	COMPRIM. ÚTIL=400	COMPRIM. ÚTIL=550	COMPRIM. ÚTIL=780
12	4.888,00	5.672,00		
14	5.860,00	6.714,00		
15	6.545,00	6.800,00		
16	7.270,00	7.955,00	9.682,00	11.318,00
18	7.348,00	8.162,00	9.682,00	11.436,00
19	7.480,00	8.600,00	11.296,00	11.635,00
20	7.480,00	8.600,00	10.842,00	11.729,00
22	7.689,00	8.981,00	11.181,00	12.521,00
24	7.861,00	9.838,00	12.185,00	14.334,00
25	8.127,00	10.023,00	12.416,00	14.334,00
26	8.656,00	10.708,00	13.461,00	17.712,00
28	9.585,00	10.813,00	13.265,00	18.271,00
29		12.040,00	15.029,00	17.844,00
30	10.547,00	12.040,00	15.029,00	18.913,00
32	10.547,00	12.961,00	15.029,00	19.297,00
35		14.645,00	15.029,00	24.727,00
36	12.462,00	15.875,00	16.756,00	25.184,00
38	17.003,00	22.944,00	27.204,00	
40	19.270,00	25.173,00	30.606,00	34.232,00
42		28.769,00	29.022,00	35.646,00
45		29.470,00	32.879,00	41.513,00

CINZEIS E ESCOPROS PARA MARTELOS SDS+ E SDS MAX

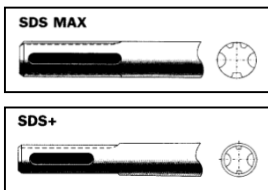
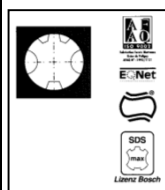

CINZEIS



ESCOPROS

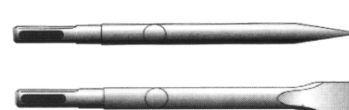

Embalagem: estojo individual

CINZEIS				ESCOPROS			
ENCABADOURO	DESIGNAÇÃO	REF. ^a	PREÇO	ENCABADOURO	DESIGNAÇÃO	REF. ^a	PREÇO
	SDS+ Ø14x250	SDS+ REF. ^a 323	1.488,00		SDS+ Ø20x250	SDS+ REF. ^a 318	1.499,00
					SDS MAX Ø24x280		1.928,00
	SDS MAX Ø18x400	SDS MAX REF. ^a 342	2.315,00		SDS MAX Ø24x400	SDS MAX REF. ^a 343	2.374,00
					SDS MAX Ø50x360		4.474,00

ESCOPROS E CINZEIS REX - SDS PLUS / SDS MAX

ECEF

TIPOS DE CINZEIS E ESCOPROS

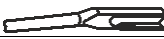
	De bico
	Plano
	Largo
	Goiva
	Para azulejos

SDS-PLUS EXTREME / SDS-MAX EXTREME:

- Aço com três zonas de têmpera diferentes;
- Ponta extremamente dura;
- Corpo elástico para amortecer os golpes;
- Com rasgos, para uma maior potência e eliminação de detritos;
- 30% de eficiência a mais relativamente às ferramentas Standard.



Embalagem
BLISTER





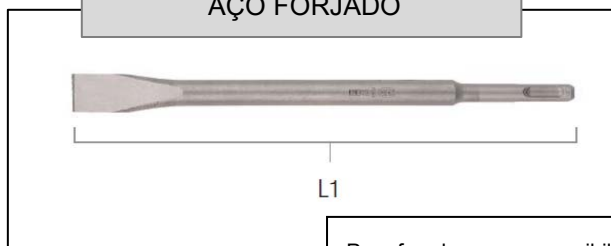



SDS-PLUS STANDARD AÇO FORJADO



SDS-PLUS EXTREME AÇO COM 3 TÊMPERAS DIFERENTES

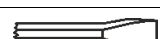

• Para furadoras com possibilidade de exclusão da rotação.

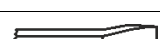
Encabadouro	Qualidade	Tipo	Largura [mm]	L1 [mm]	CÓDIGO	PREÇO
	STANDARD		Bico	250	16200	5,60
			20	250	16250	5,60
			40	250	16280	10,30
			22	250	16290	9,80
			40	250	16295	9,40
	EXTREME		Bico	250	16200EP	20,00
			20	250	16250EP	20,00







SDS-MAX STANDARD AÇO FORJADO



SDS-MAX EXTREME AÇO COM 3 TÊMPERAS DIFERENTES

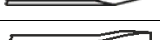

• Para martelos eletro-perfuradores.

Encabadouro	Qualidade	Tipo	Largura [mm]	L1 [mm]	CÓDIGO	PREÇO
	STANDARD		Bico	280	16300	11,90
				400	16310	13,90
				600	16320	19,80
			25	280	16350	11,90
				400	16360	13,90
				600	16370	19,80
		50	400	16380	16,80	
			75	300	16395	32,10
	EXTREME		26	300	16390	38,40
						Bico
	25	350	16360EP	31,00		

**BROCAS PARA PEDRA / BETÃO
SDS-MAX COM 3 LÂMINAS
"Y CUTTER" / "KING"**

ECEF



**Y - CUTTER®
SDS-MAX**



**Vantagens: Y CUTTER
relativamente ao tradicional
"Quadrado X"**

- Menor fricção durante a furação
- Maior velocidade e menor vibração
- Evacuação dos detritos facilitada
- +30% de rendimento e maior longevidade da ferramenta.

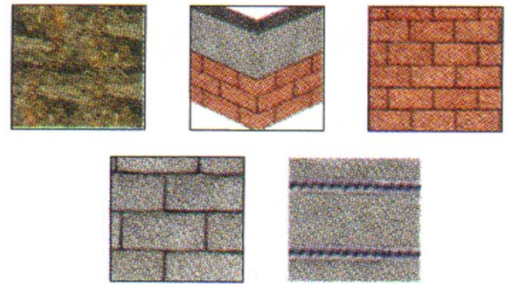

- Ø12, Ø14 e Ø15 apenas 2 cortantes
- A partir de Ø16:
- Y cutter com 3 cortantes ;
- KING com 6 cortantes.

Embalagem : 1 Unidade

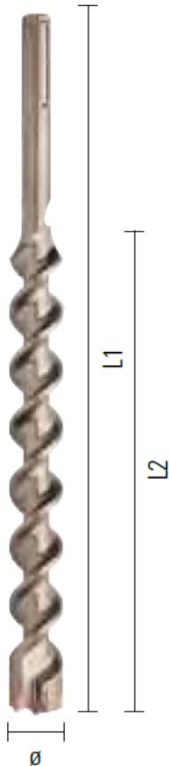

BROCA SDS-MAX "KING"

- 3 PONTAS EM CARBETO DE TUNGSTÊNIO AUTOCENTRANTES
- 6 LÂMINAS

Ø x L1 [mm]	ECEF				Y - CUTTER® SDS-MAX	PREÇO
	L2 [mm]	L3 [mm]	CÓDIGO "KING"	CÓDIGO "Y-CUTTER"		
12 X 340	200	170	21120340	19636	38,40	
12 X 540	400	380	21120540	19637	55,20	
12 X 690	550	520		19638	62,40	
14 X 340	200	170	21140340	19601	40,80	
14 X 540	400	380	21140540	19602	54,00	
15 X 340	200	170		19639	42,00	
15 X 540	400	380		19640	56,40	
16 X 340	200	180	21160340	19603	62,00	
16 X 540	400	380	21160540	19604	76,00	
18 X 340	200	180	21180340	19605	51,60	
18 X 540	400	380	21180540	19606	67,20	
18 X 940	800	780	21180920	19641	123,60	
20 X 320	200	180	21200340	19607	55,20	
20 X 520	400	380	21200540	19608	68,40	
20 X 920	800	780	21200920	19642	128,40	
22 X 320	200	180	21220340	19609	64,80	
22 X 520	400	380	21220540	19610	74,40	
22 X 920	800	780	21220920	19611	132,00	
24 X 320	200	180	21240340	19643	75,60	
24 X 520	400	380	21240540	19644	87,60	
25 X 320	200	180	21250340	19612	73,20	
25 X 520	400	380	21250540	19613	86,40	
25 X 920	800	780	21250920	19614	156,00	
28 X 370(320)	250	240		19616	97,20	
28 X 570	450	440	21280540	19617	106,80	
30 X 320	200	240		19618	106,80	
30 X 520	400	440	21300540	19619	116,40	
32 X 370	250	240		19620	127,20	
32 X 520	400	440	21320540	19621	133,20	
32 X 920	800	780	21320920	19630	230,40	
35 X 570	450	440	21350540	19623	151,20	
38 X 520	400	440	21380540	19625	187,20	
40 X 520	400	440	21400540	19626	214,80	
45 X 520	400	440	21450540	19652	321,60	
50 X 520	400	440		19653	403,20	

BROCA ESPECIAL PARA GRÉS, KLINKER, GRANITOS E MATERIAIS MUITO DUROS

ECEF



UTILIZAÇÃO
COM ÁGUA



SÓ ROTAÇÃO
NÃO PERCUSSÃO



1 Unid.

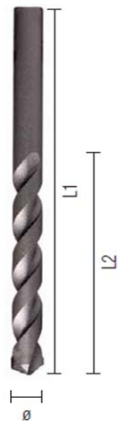

Embalagem
BLISTER

- Para furar Grés porcelanado fino com índice PEI 5;
- Ponta única, com ângulo assimétrico da pastilha de Carboneto de Tungsténio, concebida para a furação de produtos cerâmicos de grande dureza sem dificuldade;
- Facilidade de utilização sem necessidade de utilizar guias antideslizamento;
- Utilização com água;
- Pode-se furar sem água, embora o desempenho seja reduzido;
- Grande rendimento sobre grés de dureza PEI 5 - sobre materiais com dureza inferior o rendimento multiplica-se proporcionalmente;
- Produto económico, tendo em atenção o rendimento que possui;
- Possibilidade de fazer furos com pequenos diâmetros;



Tabela de durezas GRÉS

Índice PEI	Dureza	Utilização
1	baixa	pouquíssimo trânsito
2	média-baixa	pouco trânsito
3	média-alta	médio trânsito
4	alta	muito trânsito
5	muito alta	zona industrial
6 - 7 - 8	extrema	muitíssimo trânsito

Ø [mm]	L1 [mm]	L2 [mm]	CÓDIGO	PREÇO
4	75	43	01PTA04	3,47
5	85	50	01PTA05	3,89
6	100	60	01PTA06	4,68
8	120	80	01PTA08	5,96
10	120	82	01PTA10	7,81
12	150	101	01PTA12	11,35

BROCA/FRESA DIAMANTADA PARA GRÉS, KLINKER, VIDRO, GRANITOS E MATERIAIS MUITO DUROS

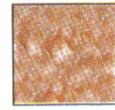
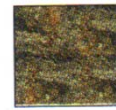
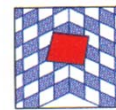
ECEF



Embalagem
BLISTER

1 Unid.



SÓ ROTAÇÃO
NÃO PERCUSSÃO



- Utilizar apenas com rotação e água refrigerante.
- Velocidade: 2000/2800 rpm com água abundante.
- Continuar a manter o furo banhado durante a furação.
- Exercer uma pressão leve e constante para ajudar a introdução da broca-fresa no furo.

Atenção: a pressão leve e constante e a utilização de água aumentam consideravelmente a duração da ferramenta.

Tabela de durezas GRÉS

índice PEI	Dureza	Utilização
1	baixa	pouquíssimo trânsito
2	média-baixa	pouco trânsito
3	média-alta	médio trânsito
4	alta	muito trânsito
5	muito alta	zona industrial
6 - 7 - 8	extrema	muitíssimo trânsito

Ø [mm]	L1 [mm]	L2 [mm]	CÓDIGO	PREÇO
5	70	40	02VHS05	17,60
6	70	40	02VHS06	17,60
8	80	40	02VHS08	20,50
10	80	40	02VHS10	23,00
12	80	40	02VHS12	27,00
14	80	40	02VHS14	30,00
15	80	40	02VHS15	31,00
16	90	50	02VHS16	32,00
20	90	50	02VHS20	38,00
25	90	50	02VHS25	48,00
30	90	50	02VHS30	60,00

ACESSÓRIOS PARA BROCAS DIAMANTADAS



1 Unid.

PREÇO

Guia simples em plástico 02VHS.VEN		Guia simples em plástico para furos Ø 4 - 5 - 6 - 8 - 10 mm	02VHS.VEN	8,50
Jogo completo de guia Ø pequenos 02KIT.VEN		Jogo completo de guia para furos Ø 4 - 5 - 6 - 8 - 10 - 12 mm	02KIT.VEN	33,00
Jogo completo de guia Ø grandes 02VHS.GRA		Jogo completo de guia para furos Ø 10 a Ø 85 mm	02VHS.GRA	58,00

GAMA COMPLETA DE LIXAS
TRABALHOS À MÃO E COM MÁQUINA



INDASA

Abrasivos

Sistemas de lixagem profissionais para um acabamento de superfícies de excelência

GAMA DE PRODUTOS

DISCOS



RHYNOGRIP
WHITE LINE

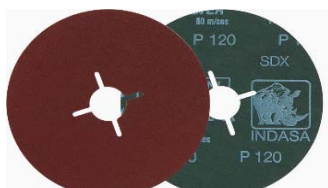

RHYNOFIBRE
'A' SILVER

FOLHAS

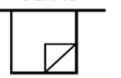

RHYNALOX
RHYNODRY
WHITE LINE



RHYNOWET
PLUS LINE



RHYNOWET
WHITE LINE



RHYNOWOOD



RHYNOBLUE



RHYNOMETAL

ROLOS



RHYNOMETAL



RHYNO X/A

ESPONJAS



RHYNSOFT
PRE-CUT



Espanjas auto
dupla face



Espanjas auto

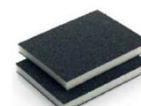

Espanjas
dupla face

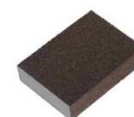







Tacos 4 faces

DISCOS DE LIXA



RHYNOGRIP WHITE LINE

Papel C e D
Óx. Alumínio

Ø 150 mm - 15 FUROS	Caraterísticas	Grão	Código		PREÇO
	<p>Elevada capacidade de corte inicial - Rápida remoção de material; Camada resistente ao empapamento - Longa duração; Uso geral - Melhor relação qualidade preço.</p>	P60	392291	5x50	57,52
		P80	392307	5x50	53,33
		P100	392314	5x50	48,10
		P120	392321	5x50	47,06
		P150	392338	5x50	47,06
		P180	392345	5x50	47,06
		P220	392352	5x50	47,06
		P240	392369	5x50	47,06
		P280	392376	5x50	47,06
		P320	392383	5x50	47,06
		P360	392390	5x50	47,06
		P400	392406	5x50	47,06
		P500	392413	5x50	47,06
P600	392420	5x50	47,06		
Ø 150 mm - 6 FUROS	Caraterísticas	Grão	Código		PREÇO
	<p>Elevada capacidade de corte inicial - Rápida remoção de material; Camada resistente ao empapamento - Longa duração; Uso geral - Melhor relação qualidade preço.</p>	P40	002466	5x50	58,56
		P60	002473	5x50	56,47
		P80	002480	5x50	52,29
		P100	002497	5x50	47,06
		P120	002503	5x50	47,06
		P150	004552	5x50	47,06
		P180	004569	5x50	47,06
		P220	004576	5x50	47,06
		P240	004583	5x50	47,06
		P280	004590	5x50	47,06
		P320	004606	5x50	47,06
		P360	004613	5x50	47,06
		P400	004620	5x50	47,06
Ø 150 mm	Caraterísticas	Grão	Código		PREÇO
	<p>Elevada capacidade de corte inicial - Rápida remoção de material; Camada resistente ao empapamento - Longa duração; Uso geral - Melhor relação qualidade preço.</p>	P40	002367	5x50	58,56
		P60	002374	5x50	56,47
		P80	002381	5x50	52,29
		P100	002398	5x50	47,06
		P120	002404	5x50	47,06
		P150	004392	5x50	47,06
		P180	004408	5x50	47,06
		P220	004415	5x50	47,06
		P240	004422	5x50	47,06
		P280	004439	5x50	47,06
		P320	004446	5x50	47,06
		P360	004453	5x50	47,06
		P400	004460	5x50	47,06
P500	156244	5x50	47,06		
P600	156282	5x50	47,06		

DISCOS DE LIXA



RHYNOGRIP WHITE LINE

Papel C e D
Óx. Alumínio

Ø 125 mm - 8 FUROS I	Caraterísticas	Grão	Código		PREÇO
	<p>Elevada capacidade de corte inicial - Rápida remoção de material; Camada resistente ao empapamento - Longa duração; Uso geral - Melhor relação qualidade preço.</p>	P40	002681	50	60,49
		P60	002698	50	58,02
		P80	002704	50	55,56
		P100	002711	50	50,62
		P120	002728	50	50,62
		P150	005033	50	50,62
		P180	005040	50	50,62
		P220	005057	50	50,62
		P240	005064	50	50,62
		P280	005071	50	50,62
		P320	005088	50	50,62
		P360	005095	50	50,62
		P400	005101	50	50,62

Ø 125 mm	Caraterísticas	Grão	Código		PREÇO
	<p>Elevada capacidade de corte inicial - Rápida remoção de material; Camada resistente ao empapamento - Longa duração; Uso geral - Melhor relação qualidade preço.</p>	P40	018965	50	60,49
		P60	018972	50	58,02
		P80	018989	50	55,56
		P100	018996	50	50,62
		P120	019009	50	50,62
		P150	019542	50	50,62
		P180	019559	50	50,62
		P220	019566	50	50,62
		P240	019573	50	50,62
		P280	019580	50	50,62
		P320	019597	50	50,62
		P360	019603	50	50,62
		P400	019610	50	50,62

Ø 225 mm - 15 FUROS	Caraterísticas	Grão	Código		PREÇO
	<p>Elevada capacidade de corte inicial - Rápida remoção de material; Camada resistente ao empapamento - Longa duração; Uso geral - Melhor relação qualidade preço.</p>	P80	393772	50	133,33
		P100	391884	50	125,93
		P120	391785	50	122,22
		P150	391792	50	122,22
		P180	391808	50	122,22
		P220	393987	50	122,22
		P240	459119	50	122,22

Ø 225 mm - 6 FUROS 10	Caraterísticas	Grão	Código		PREÇO
	<p>Elevada capacidade de corte inicial - Rápida remoção de material; Camada resistente ao empapamento - Longa duração; Uso geral - Melhor relação qualidade preço.</p>	P60	502778	50	137,04
		P80	473849	50	133,33
		P100	473856	50	125,93
		P120	473863	50	122,22
		P150	473870	50	122,22

DISCOS DE LIXA



Ø 115 x 22 mm (com rasgos)	RHYNOFIBRE 'A' SILVER				Fibra vulcaniz. Óx. Alumínio
	Caraterísticas	Grão	Código		PREÇO
	<p>Suporte de elevada resistência - Resistente a vincos e rasgamento (Fibra vulcanizada);</p> <p>Elevada capacidade de corte inicial - Rápida remoção de material;</p> <p>Resina de elevada resistência - Minimiza a queda de grão.</p>	P16	053096	25	127,16
		P24	053102	25	107,41
		P36	053119	25	104,94
		P40	053126	25	102,47
		P50	053133	25	98,77
		P60	053140	25	93,83
		P80	053157	25	91,36
		P100	053164	25	91,36
P120	053171	25	91,36		
Ø 127 x 22 mm (com rasgos)	RHYNOFIBRE 'A' SILVER				Fibra vulcaniz. Óx. Alumínio
	Caraterísticas	Grão	Código		PREÇO
	<p>Suporte de elevada resistência - Resistente a vincos e rasgamento (Fibra vulcanizada);</p> <p>Elevada capacidade de corte inicial - Rápida remoção de material;</p> <p>Resina de elevada resistência - Minimiza a queda de grão.</p>	P24	053195	25	118,52
		P36	053201	25	116,05
		P40	053218	25	112,35
		P50	053225	25	107,41
		P60	053232	25	103,70
		P80	053249	25	98,77
		P100	053256	25	98,77
		P120	053263	25	98,77
Ø 180 x 22 mm (com rasgos)	RHYNOFIBRE 'A' SILVER				Fibra vulcaniz. Óx. Alumínio
	Caraterísticas	Grão	Código		PREÇO
	<p>Suporte de elevada resistência - Resistente a vincos e rasgamento (Fibra vulcanizada);</p> <p>Elevada capacidade de corte inicial - Rápida remoção de material;</p> <p>Resina de elevada resistência - Minimiza a queda de grão.</p>	P24	053287	25	193,83
		P36	053294	25	188,89
		P40	053300	25	176,54
		P50	053317	25	170,37
		P60	053324	25	164,20
		P80	053331	25	151,85
		P100	053348	25	151,85
		P120	053355	25	151,85

ACESSÓRIOS PARA DISCOS DE LIXA





Ø 150 mm 15 FUROS		PRATOS PARA DISCOS GRIP			
	Caraterísticas	Grão	Código		PREÇO €/Unid.
		-	610121	1	56,42
Ø 125 mm 8 FUROS I		PRATOS PARA DISCOS GRIP			
	Caraterísticas	Grão	Código		PREÇO €/Unid.
		-	406915	1	56,56
Ø 150 mm		PRATOS PARA DISCOS AUTOCOLANTES			
	Caraterísticas	Grão	Código		PREÇO €/Unid.
		-	142554	1	59,05
Ø 115 / 125 / 178 mm		PRATOS PARA DISCOS DE FIBRA			
	Caraterísticas	Ø	Código		PREÇO €/Unid.
		115 mm	355879	1	17,25
		125 mm	355886	1	18,63
		178 mm	355893	1	26,14
Ø 150 mm 15 FUROS		INTERFACES GRIP			
	Caraterísticas	Grão	Código		PREÇO €/Unid.
		-	442630	1	17,65
Ø 125 mm 8 FUROS I		INTERFACES GRIP			
	Caraterísticas	Grão	Código		PREÇO €/Unid.
		-	531099	1	15,97

FOLHAS DE LIXA



230 x 280 mm	RHYNOWET PLUS LINE	Papel C,A Latex Óx. Alumínio/ Carb. Silício
---------------------	---------------------------	--

 <div style="text-align: center; margin-top: 20px;">  <p>Lixagem a húmido</p> </div>	Caraterísticas	Grão	Código		PREÇO	
			P60	000523	5x50	118,95
			P80	000530	5x50	105,88
			P100	000547	5x50	99,35
			P120	000554	5x50	87,58
			P150	000561	5x50	75,82
			P180	000578	5x50	73,20
			P220	000585	5x50	73,20
			P240	000592	5x50	73,20
			P280	000608	5x50	73,20
			P320	000615	5x50	73,20
			P360	000622	5x50	73,20
			P400	000639	5x50	73,20
			P500	000646	5x50	73,20
			P600	000653	5x50	73,20
			P800	000660	5x50	73,20
			P1000	000677	5x50	73,20
			P1200	000684	5x50	73,20
		P1500	226329	5x50	81,05	
		P2000	226343	5x50	81,05	
		P2500	226381	5x50	81,05	

Elevada flexibilidade - Adapta-se a contornos e superfícies curvas;
Acabamento uniforme - Preparação perfeita do substrato;
Antideslizante - Uso fácil.

230 x 280 mm	RHYNOWET WHITE LINE	Papel C Óx. Alumínio
---------------------	----------------------------	---------------------------------

 <div style="text-align: center; margin-top: 20px;">  <p>Lixagem a húmido</p> </div>	Caraterísticas	Grão	Código		PREÇO	
			P60	388607	5x50	84,97
			P80	605216	5x50	81,05
			P100	605223	5x50	70,59
			P120	605230	5x50	67,97
			P150	605247	5x50	62,75
			P180	605254	5x50	57,52
			P220	605476	5x50	57,52
			P240	605261	5x50	57,52
			P280	605278	5x50	57,52
			P320	605285	5x50	57,52
			P360	605292	5x50	57,52
			P400	605308	5x50	57,52
			P500	605315	5x50	57,52
			P600	605322	5x50	57,52
		P800	605339	5x50	57,52	
		P1000	605346	5x50	57,52	
		P1200	605353	5x50	57,52	

Elevada capacidade de corte inicial - Rápida remoção de material;

FOLHAS DE LIXA



230 x 280 mm		RHYNALOX WHITE LINE			Papel D Óx. Alumínio
	Caraterísticas	Grão	Código		PREÇO
	Elevada capacidade de corte inicial - Rápida remoção de material; Camada resistente ao empapamento - Longa duração; Uso geral - Melhor relação qualidade preço.	P60	000721	5x50	75,82
		P80	000738	5x50	70,59
		P100	000745	5x50	66,67
		P120	000752	5x50	65,36
230 x 280 mm		RHYNODRY WHITE LINE			Papel C e A Óx. Alumínio
	Caraterísticas	Grão	Código		PREÇO
	Elevada capacidade de corte inicial - Rápida remoção de material; Camada resistente ao empapamento - Longa duração; Uso geral - Melhor relação qualidade preço.	P150	011543	5x50	65,36
		P180	011550	5x50	65,36
		P220	011567	5x50	65,36
		P240	011574	5x50	65,36
		P280	011581	5x50	65,36
		P320	011598	5x50	65,36
		P360	011604	5x50	65,36
P400		011611	5x50	65,36	
230 x 280 mm		RHYNOWOOD			Papel B Óx. Alumínio
	Caraterísticas	Grão	Código		PREÇO
	Acabamento uniforme - Preparação perfeita do substrato; Uso geral - Melhor relação qualidade preço.	P40	006594	5x50	73,20
		P50	006600	5x50	67,97
		P60	006617	5x50	65,36
		P80	006624	5x50	57,52
		P100	006631	5x50	53,59
		P120	006648	5x50	48,37
		P150	006655	5x50	48,37
		P180	006662	5x50	48,37
		P220	006679	5x50	48,37
		P240	006686	5x50	48,37
		P280	006693	5x50	48,37
P320		006709	5x50	48,37	
230 x 280 mm		RHYNOBLUE			Tela de algodão Óx. Alumínio
	Caraterísticas	Grão	Código		PREÇO
	Elevada flexibilidade - Adapta-se a contornos e superfícies curvas; Uso geral - Melhor relação qualidade preço.	P50	276713	5x50	134,64
		P60	276683	5x50	130,72
		P80	276690	5x50	130,72
		P100	276447	5x50	129,41
		P120	275396	5x50	129,41
		P150	276706	5x50	124,18
		P180	276768	5x50	124,18
P220		278489	5x50	124,18	
230 x 280 mm		RHYNOMETAL			Tela algodão F Óx. Alumínio
	Caraterísticas	Grão	Código		PREÇO
	Suporte de elevada resistência - Resistente a vincos e rasgamento Elevada flexibilidade - Adapta-se a contornos e superfícies curvas; Uso geral - Melhor relação qualidade preço.	P80	014001	5x50	189,54
		P100	014018	5x50	180,39
		P120	014025	5x50	177,78
		P150	014032	5x50	171,24
		P180	014049	5x50	171,24
P220		055691	5x50	171,24	

ROLOS DE LIXA



Dimensões	RHYNOMETAL				Tela algodão F Óx. Alumínio
115 mm x 25 m	Caraterísticas	Grão	Código		PREÇO €/Unid.
	Suporte de elevada resistência - Resistente a vincos e rasgamento Elevada flexibilidade - Adapta-se a contornos e superfícies curvas; Uso geral - Melhor relação qualidade preço.	P40	189917	1	91,49
		P50	391877	1	90,75
		P60	174654	1	86,98
		P80	187548	1	84,17
		P100	187555	1	82,95
		P120	166055	1	81,95
		P150	140123	1	81,95
		P180	298527	1	81,95
		P220	170540	1	81,95
P240	192542	1	81,95		
100 mm x 50 m	Caraterísticas	Grão	Código		PREÇO €/Unid.
	Suporte de elevada resistência - Resistente a vincos e rasgamento Elevada flexibilidade - Adapta-se a contornos e superfícies curvas; Uso geral - Melhor relação qualidade preço.	P40	140604	1	148,94
		P50	140611	1	147,11
		P60	140628	1	141,62
		P80	140635	1	137,05
		P100	140642	1	134,33
		P120	140659	1	133,41
		P150	140666	1	133,41
		P180	140673	1	133,41
		P220	140680	1	133,41
P240	140697	1	133,41		
Dimensões	RHYNO X/A				Tela algodão X Óx. Alumínio
250 mm x 25 m	Caraterísticas	Grão	Código		PREÇO €/Unid.
	Suporte de alta resistência - Resistente a vincos e rasgos; Alto poder de corte inicial - Desbaste rápido; Resina de alta resistência - Menor perda de grão.	P40	047149	1	317,28
		P50	047156	1	309,27
		P60	047163	1	278,72
		P80	047170	1	271,66
		P100	047187	1	266,97
		P120	047194	1	258,05
		P150	229170	1	258,05
		P180	254349	1	258,05
		P240	269985	1	258,05
150 mm x 25 m	Caraterísticas	Grão	Código		PREÇO €/Unid.
	Suporte de alta resistência - Resistente a vincos e rasgos; Alto poder de corte inicial - Desbaste rápido; Resina de alta resistência - Menor perda de grão.	P40	364239	1	190,38
		P50	382127	1	181,80
		P60	286883	1	167,35
		P80	046722	1	162,75
		P100	234976	1	159,90
		P120	201220	1	157,93
		P150	142912	1	157,93
		P180	506516	1	157,93
		P220	331279	1	157,93
P240	427460	1	157,93		
115 mm x 50 m	Caraterísticas	Grão	Código		PREÇO €/Unid.
	Suporte de alta resistência - Resistente a vincos e rasgos; Alto poder de corte inicial - Desbaste rápido; Resina de alta resistência - Menor perda de grão.	P40	048924	1	292,34
		P50	048931	1	278,69
		P60	048948	1	256,64
		P80	048955	1	250,05
		P100	048962	1	245,15
		P120	048979	1	242,54
		P150	048986	1	242,54
		P180	048993	1	242,54
		P220	143261	1	242,54
P240	143278	1	242,54		

ESPONJAS DE LIXA







115 mm x 25 m		RHYNOSOFT PRE-CUT			Papel B e C Latex+Esponja Óx. Alumínio
	Caraterísticas	Grão	Código		PREÇO €/Unid.
	<p>Elevada flexibilidade - Adapta-se a contornos e superfícies curvas;</p> <p>Suporte de espuma - Previne lixagem em excesso;</p> <p>Resistente ao rasgamento - Ideal para lixagem manual em áreas de difícil acesso;</p> <p>Rolo pré-cortado - Fácil manuseamento;</p> <p>1 Tira - Perfeito para lixagem manual;</p> <p>2 Tiras - Dimensão de lixagem à máquina;</p> <p>Impressão na esponja - Melhor identificação;</p> <p>Perfuração inovadora - Alta resistência a tração.</p>	P120	602249	1	71,84
		P150	594131	1	71,84
		P180	594148	1	71,84
		P220	597155	1	71,84
		P240	594162	1	71,84
		P320	594186	1	71,84
		P400	594193	1	71,84
		P500	594209	1	71,84
		P600	594216	1	71,84
P800		594223	1	71,84	
P1000	594230	1	71,84		
P1500	602263	1	71,84		
98 x 120 x 13 mm		ESPONJAS AUTO DUPLA FACE			Esponja Óx. Alumínio
	Caraterísticas	Grão	Código		PREÇO €/Unid.
	<p>Elevada flexibilidade - Adapta-se a contornos e superfícies curvas;</p> <p>Suporte de esponja - Previne lixagem em excesso;</p> <p>Resistente ao rasgamento - Ideal para lixagem manual em áreas de difícil acesso.</p>	Medium	595077	100	0,99
		Fine	595107	100	0,99
		Super Fine	595121	100	0,99
		Ultra Fine	595145	100	0,99
		Microfine	595169	100	0,99
115 x 140 x 5 mm		ESPONJAS AUTO			Esponja Óx. Alumínio
	Caraterísticas	Grão	Código		PREÇO €/Unid.
	<p>Elevada flexibilidade - Adapta-se a contornos e superfícies curvas;</p> <p>Suporte de esponja - Previne lixagem em excesso;</p> <p>Resistente ao rasgamento - Ideal para lixagem manual em áreas de difícil acesso.</p>	Fine	012796	20	1,36
Microfine		012819	20	1,36	
98 x 122 x 12 mm		ESPONJAS DUPLA FACE (madeira)			Esponja Óx. Alumínio
	Caraterísticas	Grão	Código		PREÇO €/Unid.
	<p>Elevada flexibilidade - Adapta-se a contornos e superfícies curvas;</p> <p>Suporte de esponja - Previne lixagem em excesso;</p> <p>Resistente ao rasgamento - Ideal para lixagem manual em áreas de difícil acesso.</p>	P60	014479	10	1,02
		P100	014486	10	1,02
		P120	014493	10	1,02
P150		014509	10	1,02	
98 x 69 x 26 mm		TACOS 4 FACES			Esponja Óx. Alumínio
	Caraterísticas	Grão	Código		PREÇO €/Unid.
	<p>Bloco de Esponja de alta densidade - Ideal para lixagem de arestas e cantos;</p> <p>Resina de elevada resistência - Minimiza a queda de grão.</p>	P60	462997	50	1,11
		P80	534731	50	1,11
		P100	463000	50	1,11
		P120	534748	50	1,11
		P150	534755	50	1,11
P180		463017	50	1,11	

BITS FENDA













• PARA PARAFUSOS FENDADOS

PRODUTO	CARACTERÍSTICAS	CÓDIGO WERA				PREÇO
STANDARD  Ref.ª 800/1 TZ	• Com "zona de torção" Encabadoiro: • Hexagonal de 1/4" • DIN 3126-C6,3; ISO 1173 Ponta: • Extra dura • DIN 5264-C, ISO 2380	056247	0,5x4	25	10	2,83
		056203 (novo)	0,5x4	25	10	2,83
		056255	0,6x4,5	25	10	2,83
		056210 (novo)	0,6x4,5	25	10	2,83
		056265	0,8x5,5	25	10	2,83
		056220 (novo)	0,8x5,5	25	10	2,83
		056267	1,0x5,5	25	10	2,83
056225 (novo)	1,0x5,5	25	10	2,83		
056277	1,2x6,5	25	10	2,83		
056233 (novo)	1,2x6,5	25	10	2,83		
STANDARD LONGO  Ref.ª 800/4 Z	Encabadoiro: • Hexagonal de 1/4"; • DIN 3126-E6,3; ISO 1173 Ponta: • Qualidade profissional;; • DIN 5264-C, ISO 2380	059307	0,5x4	50	10	6,34
		059315	0,6x4,5	50	10	6,34
		059325	0,8x5,5	50	10	6,34
		059330	1,0x5,5	50	10	6,34
		059337	1,2x6,5	50	10	6,34

BITS PHILIPS



• PARA PARAFUSOS COM FENDA PHILIPS

PRODUTO	CARACTERÍSTICAS	CÓDIGO WERA				PREÇO
STANDARD  Ref.ª 851/1 Z	Encabadoiro: • Hexagonal de 1/4"; • DIN 3126-C6,3; ISO 1173 Ponta: • Qualidade profissional • DIN 5260-PH, ISO 8764-PH	072070	PH 1	25	10	0,83
		072400 (blister)	PH 1	25	10	0,83
		072072	PH 2	25	10	0,83
		072401 (blister)	PH 2	25	10	0,83
EXTRA DURO (amarelo)  Ref.ª 851/1 TH	Encabadoiro: • Hexagonal de 1/4"; • DIN 3126-C6,3; ISO 1173 Ponta: • Extra dura • DIN 5260-PH, ISO 8764-PH	072074	PH 3	25	10	1,25
		072402 (blister)	PH 3	25	10	1,25
		056605	PH 1	25	10	1,30
		134550 (blister)	PH 1	25	10	1,30
EXTRA DURO PARA CHAPA / METAL  Ref.ª 851/1 TZ	Encabadoiro: • Hexagonal de 1/4"; • DIN 3126-D 6,3; ISO 1173 Design: • Ponta extra dura • DIN 5260-PH, ISO 8764-PH • Com zona de torção - p/ chapa/metal	056610	PH 2	25	10	1,30
		134551 (blister)	PH 2	25	10	1,30
		056625	PH 3	25	10	2,31
		134552 (blister)	PH 3	25	10	2,31
BiTorsion® DIAMANTE  Ref.ª 851/1 BDC	Encabadoiro: • Hex-plus 1/4" • ≈ DIN 3126-C6,3; ISO 1173 Ponta: • Com revestimento diamante • DIN 5260-PH, ISO 8764-PH	056400	PH 1	25	10	6,00
		056402	PH 2	25	10	6,00
		056404	PH 3	25	10	6,00
EXTRA DURO (amarelo) LONGO  Ref.ª 851/4 TH	Encabadoiro: • Hexagonal de 1/4"; • DIN 3126-E6,3; ISO 1173 Ponta: • Extra dura • DIN 5260-PH, ISO 8764-PH	059855	PH 1	50	10	3,70
		059860	PH 2	50	10	3,70
		134560 (blister)	PH 2	50	5	3,70
EXTRA DURO LONGO PARA CHAPA / METAL  Ref.ª 851/4 TZ	Encabadoiro: • Hexagonal de 1/4"; • DIN 3126-F6,3; ISO 1173 Design: • Ponta extra dura • DIN 5260-PH, ISO 8764-PH • Com zona de torção - p/ chapa/metal	059865	PH 3	50	10	4,50
		059805	PH 1	50	10	3,60
		072426 (blister)	PH 1	50	5	3,60
STANDARD LONGO  Ref.ª 851/4 Z	Encabadoiro: • Hexagonal de 1/4"; • DIN 3126-E6,3; ISO 1173 Ponta: • Qualidade profissional;; • DIN 5260-PH, ISO 8764-PH	059810	PH 2	50	10	3,60
		072427 (blister)	PH 2	50	5	3,60
		059815	PH 3	50	10	4,34
		134564 (blister)	PH 3	50	5	4,34
		059760	PH 1	89	10	10,50
059775	PH 2	89	10	10,50		
059780	PH 2	110	10	12,00		
059795	PH 3	89	10	10,50		
059800	PH 3	110	10	12,00		

Edição: 1/2006

Revisão: 3

Preço: €/Unidade

TABELA 12.1

Data: Setembro 2006

Data: 22 de abril 2024

BIT'S POZIDRIVE



• PARA PARAFUSOS COM FENDA POZIDRIVE / SUPADRIVE

PRODUTO	CARACTERÍSTICAS	CÓDIGO WERA				PREÇO
STANDARD Ref.ª 855/1 Z	Encabadouro: • Hexagonal de 1/4"; • DIN 3126-C6,3; ISO 1173 Ponta: • Qualidade profissional;; • DIN 5260-PZ, ISO 8764-PZ	072080 072403(blisters)	PZ 1	25	10	0,83
		072082 072404(blisters)	PZ 2	25	10	0,83
		072084 072405(blisters)	PZ 3	25	10	1,25
EXTRA DURO (amarelo) Ref.ª 855/1 TH	• Com "Zona de Torção" Encabadouro: • Hexagonal de 1/4"; • DIN 3126-C6,3; ISO 1173 Ponta: • Extra dura • DIN 5260-Pz, ISO 8764-Pz	056910 134556(blisters)	PZ 1	25	10	1,20
		056915 072417(blisters)	PZ 2	25	10	1,20
		056925 134558(blisters)	PZ 3	25	10	1,80
TITÂNIO Ref.ª 855/1 TIN	• Com "Zona de Torção" Encabadouro: • Hexagonal de 1/4"; • DIN 3126-C6,3; ISO 1173 Ponta: • Com revestimento de titânio • DIN 5260-Pz, ISO 8764-Pz	480221	PZ 1	25	10	4,00
		480222	PZ 2	25	10	4,00
		480223	PZ 3	25	10	4,00
BiTorsion® DIAMANTE Ref.ª 855/1 BDC	Encabadouro: • Hex-plus 1/4" • ≈ DIN 3126-C6,3; ISO 1173 Ponta: • Com revestimento diamante • DIN 5260-PZ, ISO 8764-PZ	056700	PZ 1	25	10	6,20
		056702	PZ 2	25	10	6,20
		056704	PZ 3	25	10	6,20
EXTRA DURO (amarelo) LONGO Ref.ª 855/4 TH	• Com "Zona de Torção" Encabadouro: • Hexagonal de 1/4"; • DIN 3126-E6,3; ISO 1173 Ponta: • Extra dura • DIN 5260-PZ, ISO 8764-PZ	060055 134566(blisters)	PZ 1	50	10 5	3,70
		060060 134567(blisters)	PZ 2	50	10 5	3,70
		060065	PZ 3	50	10	4,50
EXTRA DURO LONGO PARA CHAPA / METAL Ref.ª 855/4 TZ	Encabadouro: • Hexagonal de 1/4"; • DIN 3126-E6,3; ISO 1173 Design: • Ponta extra dura • DIN 5260-PZ, ISO 8764-PZ • Com Zona de Torção - p/ chapa/metal	060005 072429(blisters)	PZ 1	50	10 5	3,70
		060010 072430(blisters)	PZ 2	50	10 5	3,70
		060015	PZ 3	50	10	4,50
STANDARD LONGO Ref.ª 855/4 Z	Encabadouro: • Hexagonal de 1/4"; • DIN 3126-E6,3; ISO 1173 Ponta: • Qualidade profissional;; • DIN 5260-PZ, ISO 8764-PZ	060029	PZ 1	89	10	10,50
		060035	PZ 2	89	10	10,50
		060037	PZ 2	110	10	12,50
		060036	PZ 2	127	10	14,00
		060043	PZ 3	89	10	10,50
		060045	PZ 3	110	10	12,00

BIT'S TORX®



• PARA PARAFUSOS COM FENDA TORX®

PRODUTO	CARATERÍSTICAS	CÓDIGO WERA				PREÇO	
 Ref.ª 867/1 Z	Encabadoiro: • Hexagonal de 1/4"; • DIN 3126-E6,3; ISO 1173 Ponta: • TORX® • Qualidade profissional	066485	TX 10	25	10	2,10	
		072406(blisters)					
		066486	TX 15	25	10	2,10	
		072407(blisters)					
		066487	TX 20	25	10	2,10	
		072408(blisters)					
		066488	TX 25	25	10	2,10	
		072409(blisters)					
		066489	TX 27	25	10	2,10	
066490	TX 30	25	10	2,10			
072411(blisters)							
066491	TX 40	25	10	2,10			
072412(blisters)							
 Ref.ª 867/1 TZ	Encabadoiro: • Hexagonal de 1/4"; • DIN 3126-C6,3; ISO 1173 Ponta: • TORX® • Qualidade profissional	066301	TX 6	25	10	3,00	
		066302	TX 7	25	10	3,00	
		066303	TX 8	25	10	3,00	
		066310	TX 20	25	10	3,00	
		072421(blisters)					
066312	TX 25	25	10	3,00			
072422(blisters)							
 Ref.ª 867/1 Z W (Ref.ª 867/1 Z HF)	Encabadoiro: • Hexagonal de 1/4"; • DIN 3126-E6,3; ISO 1173 Ponta: • TORX®, forma cónica • Qualidade profissional	066450	TX 10	25	10	4,55	
		066455 (066073)	TX 15	25	10	4,55	
		066460 (066074)	TX 20	25	10	4,55	
		066465	TX 25	25	10	4,55	
		066475	TX 30	25	10	4,55	
 Ref.ª 867/4 Z	Encabadoiro: • Hexagonal de 1/4"; • DIN 3126-E6,3; ISO 1173 Ponta: • TORX® • Qualidade profissional	060132	TX 10	50	10	7,50	
		060186	TX 10	89	10	13,50	
		060133	TX 15	50	10	7,50	
		060187	TX 15	89	10	13,50	
		060134	TX 20	50	10	7,50	
		060188	TX 20	89	10	13,50	
		060135	TX 25	50	10	7,50	
		060189	TX 25	89	10	13,50	
		060137	TX 30	50	10	7,50	
060191	TX 30	89	10	13,50			

BIT'S TORX® INVOLÁVEL



• PARA PARAFUSOS COM FENDA TORX® INVOLÁVEL

PRODUTO	CARATERÍSTICAS	CÓDIGO WERA				PREÇO
 Ref.ª 867/1 BO	Encabadoiro: • Hexagonal de 1/4"; • DIN 3126-C6,3; ISO 1173 Ponta: • TORX® com furo • Qualidade profissional	066500	TX 10	25	10	6,00
		066505	TX 15	25	10	6,00
		066510	TX 20	25	10	6,00
		066515	TX 25	25	10	6,00

BIT'S SEXTAVADOS



• PARA PARAFUSOS COM SEXTAVADO INTERIOR

Hex-Plus®

PRODUTO	CARATERÍSTICAS	CÓDIGO WERA				PREÇO
 Ref.ª 840/1 Z	Encabadouro: • Hexagonal de 1/4"; • DIN 3126-C6,3; ISO 1173 Ponta: • Hex-Plus, similar a DIN 911 • Qualidade profissional	056303	1,5	25	10	4,00
		056305	2	25	10	4,00
		056310	2,5	25	10	4,00
		056315	3	25	10	4,00
		056320	4	25	10	4,00
		056325	5	25	10	4,00
		056330	6	25	10	4,00

ADAPTADORES PORTA-BIT's



• PARA BIT's DE 1/4"

PRODUTO	CARATERÍSTICAS	CÓDIGO WERA	- DIN 3126	- DIN 3126	COMPRIMENTO [mm]	PREÇO
DE APERTO RÁPIDO Ref.ª 895/4/1 BO	• Com aperto rápido • Com potente íman permanente	053870	1/4" - D6,3	1/4" - E6,3	77	37,00
UNIVERSAL Ref.ª 893/4/1K; 899/4/1; 899/4/1/100	• Com potente íman permanente • Com anel de retenção (L75 e L100)	134480	1/4" - D6,3	1/4" - E6,3	50	8,00
		053455	1/4" - D6,3	1/4" - E6,3	75	22,00
		053459	1/4" - D6,3	1/4" - E6,3	100	27,00

CHAVES PORTA-BIT's



• PARA BIT's DE INSERÇÃO DE 1/4" - DIN 3126-C6,3

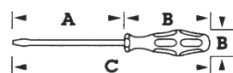







PRODUTO	CARATERÍSTICAS	CÓDIGO WERA	- DIN 3126	A [mm]	B [mm]	C [mm]	PREÇO
STANDARD Ref.ª 812/1	Haste: • Hexagonal com porta-bits magnético • Niquelada mate Punho: • Kraffform® três componentes • Com proteção antirrolante	051205	1/4" - D6,3	120	112/40	232	45,00
COM DEPÓSITO Ref.ª 819/1	Haste: • Hexagonal com porta-bits magnético • Niquelada mate Punho: • Kraffform® um componentes • Com proteção antirrolante • Com depósito para 6 bits (não incl.)	051610	1/4" - D6,3	120	120/40	240	70,00

**CONJUNTO DE BITS
BIT-CHECK 12 METAL 1**











• **PARA TRABALHOS EM METAL**

PRODUTO	CARATERÍSTICAS	CÓDIGO WERA	CONTEÚDO		PREÇO
<p>CONJUNTO DE BITS Bit-Check 12 Metal 1</p>  	<ul style="list-style-type: none"> • Encabadouro Hex-Plus para uma vida mais longa; • Adequados para apresentações em pé - funcionais em espaços pequenos; • Particularmente adequados para aplicações em metal; • Pontas extra-rígidas, para uso universal; • Porta-bits universal com soquete de aço inoxidável. <p>12 PEÇAS:</p> <ul style="list-style-type: none"> • 11 BITS • 1 porta-bits 	<p align="center">057424</p>	 899/4/1	1x 1/4"x50	<p align="center">33,00</p>
			 851/1 Z PH	1x PH 1x25; 1x PH 2x25	
			 855/1 Z PZ	1x PZ 1x25; 1x PZ 2x25	
			 867/1 TORX®	1x TX 15x25; 1x TX 20x25; 1x TX 25x25; 1x TX 30x25	
			 840/1 Z Hex-Plus	1x 3,0x25; 1x 4,0x25; 1x 5,0x25	

**CONJUNTO DE BITS
BIT-CHECK 30 METAL 1**



• **PARA TRABALHOS EM METAL**

PRODUTO	CARATERÍSTICAS	CÓDIGO WERA	CONTEÚDO		PREÇO
<p>CONJUNTO DE BITS Bit-Check 30 Metal 1</p>  	<ul style="list-style-type: none"> • Encabadouro Hex-Plus para uma vida mais longa; • Adequados para apresentações em pé - funcionais em espaços pequenos; • Particularmente adequados para aplicações em metal; • Pontas extra-rígidas, para uso universal; • Porta-bits universal com soquete de aço inoxidável. <p>30 PEÇAS:</p> <ul style="list-style-type: none"> • 29 BITS • 1 porta-bits 	<p align="center">057434</p>	 899/4/1	1x 1/4"x50	<p align="center">47,00</p>
			 851/1 Z PH	3x PH 1x25; 3x PH 2x25; 2x PH 3x25	
			 855/1 Z PZ	3x PZ 1x25; 3x PZ 2x25; 3x PZ 3x25	
			 867/1 TORX®	1x TX 10x25; 1x TX 15x25; 1x TX 20x25; 1x TX 25x25; 1x TX 30x25; 1x TX 40x25	
			 800/1 Z	1x 0,6x4,5x25; 1x 1,0x5,5x25; 1x 1,2x6,5x25	
			 840/1 Z Hex-Plus	1x 4,0x25; 1x 5,0x25; 1x 6,0x25	

JOGOS DE CHAVES SEXTAVADAS



• PARA PARAFUSOS COM SEXTAVADO INTERIOR



PRODUTO	CARACTERÍSTICAS	CÓDIGO WERA	CONTEÚDO	PREÇO
<p>JOGO DE CHAVES SEXTAVADAS</p> <p>Ref.ª 950</p>	<p>Conjunto de 9 peças em estojo de plástico.</p> <p>Haste: Hex-Plus cromada.</p>	021406	1x 1,5x45; 1x 2,0x50; 1x 2,5x56; 1x 3,0x63; 1x 4,0x70; 1x 5,0x80; 1x 6,0x90; 1x 8,0x100; 1x 10,0x112	30,00
<p>JOGO DE CHAVES SEXTAVADAS LONGAS</p> <p>Ref.ª 950 L</p>	<p>Conjunto de 9 peças em estojo de plástico.</p> <p>Haste: Hex-Plus cromada.</p>	021909	1x 1,5x90; 1x 2,0x100; 1x 2,5x112; 1x 3,0x126; 1x 4,0x140; 1x 5,0x160; 1x 6,0x180; 1x 8,0x200; 1x 10,0x219	39,00
<p>JOGO DE CHAVES SEXTAV. LONGAS - COM BOLA</p> <p>Ref.ª 950 PKL</p>	<p>Conjunto de 9 peças em estojo de plástico.</p> <p>Haste: Hex-Plus cromada com extremo em bola.</p>	022087	1x 1,5x90; 1x 2,0x100; 1x 2,5x112; 1x 3,0x126; 1x 4,0x140; 1x 5,0x160; 1x 6,0x180; 1x 8,0x200; 1x 10,0x219	65,00
<p>JOGO DE CHAVES SEXTAV. LONGAS - COM BOLA</p> <p>Ref.ª 950 SPKL Multicolour Ref.ª 950 SPKL HF Multicolour</p>	<p>Conjunto de 9 peças em estojo de plástico.</p> <p>Haste: Hex-Plus Negro Laser, com extremo em bola, revestida com plástico duradouro multicolor para identificar o tamanho. Com sistema de retenção mecânica para trabalhos em posições difíceis.</p>	022210	<p>Ref.ª 950 SPKL Multicolour 1x 1,5x90; 1x 2,0x101; 1x 2,5x112</p> <p>Ref.ª 950 SPKL HF Multicolour 1x 3,0x123; 1x 4,0x137; 1x 5,0x154; 1x 6,0x172; 1x 8,0x195; 1x 10,0x224</p>	90,00

CHAVES DE CAIXA SEXTAVADAS



• PARA PERNOS, PARAFUSOS E PORCAS DE CABEÇA SEXTAVADA

PRODUTO	CARACTERÍSTICAS	CÓDIGO WERA				PREÇO
<p>CHAVE DE CAIXA SEXTAVADA</p> <p>Ref.ª 869/4 M Ref.ª 869/4 (sem íman)</p>	<p>Encabadouro:</p> <ul style="list-style-type: none"> Hexagonal de 1/4" - DIN 3126-C6,3 <p>Boca:</p> <ul style="list-style-type: none"> DIN 475/2 Qualidade profissional Com potente íman permanente Ref. 869/4 - sem íman - ideal para parafusos de nylon 	060400	5,5	50	5	15,00
		060421	6	50	5	15,00
		060422	7	50	5	15,00
		060423	8	50	5	15,00
		060425	10	50	5	15,00
		060426	11	50	5	19,00
		060406	11 (sem íman)	50	5	19,00
		060428	13	50	5	19,00

ESCORAS DE EXPANSÃO

PIHER

Suporta até 450 kg

Caraterísticas:

- Fácil de usar, com sapatas de borracha antideslizantes, adaptáveis a diversos ângulos;
- Tubos em aço de 1mm de espessura;
- 100% resistente às intempéries;
- Punho em nylon reforçado com fibra de vidro.

Tabela de cargas

Comprimento da escora	COD				
	34000	30010	30011	30012	34004
40 cm	450 kg.				
60 cm	450 kg.	450 kg.			
100 cm		450 kg.	450 kg.		
155 cm			450 kg.	450 kg.	
170 cm			300 kg.	450 kg.	
200 cm				450 kg.	450 kg.
250 cm				220 kg.	350 kg.
290 cm				150 kg.	210 kg.
300 cm					200 kg.
325 cm					150 kg.
350 cm					90 kg.
375 cm					70 kg.

ACESSÓRIO DE APERTO RÁPIDO ARM+

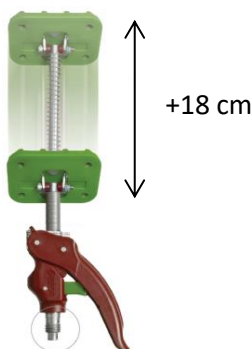

+18 cm

Desenhado para trabalhar apenas com 1 mão.

NOVO

Designação	Código				Preço
Escora de expansão n.º 0	34000	60 cm	40 cm	1,10	44,00
Escora de expansão n.º 1	30010	100 cm	60 cm	1,36	45,00
Escora de expansão n.º 2	30011	170 cm	95 cm	1,81	51,00
Escora de expansão n.º 3	30012	290 cm	155 cm	2,61	56,00
Escora de expansão n.º 4	34004	375 cm	200 cm	3,18	63,00
Acessório ARM+	34089			0,51	34,00

CAVALETE PORTÁTIL

PIHER

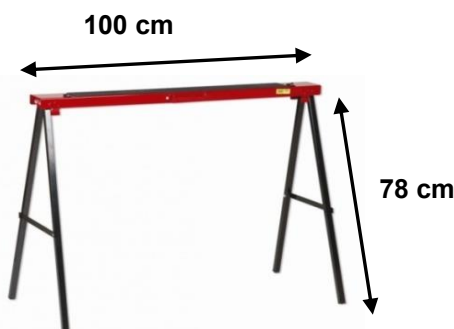

Exemplo de utilização

Caraterísticas:

- Dobrável e com asa para transportar;
- Base antideslizante na zona de apoio.
- **Capacidade de carga: 150 kg**

Designação	Código		Preço
Cavalete portátil	30031	4,3	45,00

BANDA DE APERTO RETANGULAR

PIHER



BANDA DE APERTO RETANGULAR



Caraterísticas:

- Banda em aço laminado temperado CK67S;
- Base em ferro fundido;
- Ângulos em nylon;
- Esquadrias perfeitas sem perigo de deformação;
- Pressão repartida uniformemente.

Designação	Código	Modelo	Largura da banda	Comp. da banda	Kg	Preço
Banda de aperto Retangular Modelos A, B e C	24002	A	1,2 cm	500 cm	1,29	90,00
	24003	B	2 cm	650 cm	2,09	102,00
	24004	C	2,5 cm	800 cm	2,71	110,00

BANDA DE APERTO PARA AROS

PIHER



BANDA DE APERTO PARA AROS



Caraterísticas:

- Banda em aço laminado temperado CK67S;
- Base em ferro fundido;
- Apoio em nylon;
- Juntas perfeitas sem perigo de deformação;
- Banda com arestas suavizadas;
- Pressão repartida uniformemente.

Designação	Código	Modelo	Largura da banda	Comp. da banda	Kg	Preço
Banda de aperto para aros - Modelo C	24006	C	2,5 cm	800 cm	2,37	112,00

GRAMPOS DE ÊMBOLO ROSCA OCULTA PROTEGIDA

PTHER



Modelo Maxi F

O desenho das formas de ambas as cabeças permite libertar todos os bordos e ressaltos das peças a fixar.

Modelo Maxi F

Barra: 35 mm x 8 mm
Força máxima: 9000 N



Modelo	Código					Preço
	60020	20 cm	12 cm	10 cm	2,12	37,00
	60040	40 cm	12 cm	10 cm	2,56	44,00
	60060	60 cm	12 cm	10 cm	2,78	51,00
	60080	80 cm	12 cm	10 cm	3,44	59,00
	60100	100 cm	12 cm	10 cm	3,88	67,00

GRAMPOS DE APERTO

PTHER



Modelo M

Fuso de rosca fina e punho em cruz com grande capacidade de pressão. Recomendado para trabalhos em metal.



Modelo MM

Fuso de rosca trapezoidal com punho de madeira. Recomendado para trabalhos de marcenaria.

Modelo M

Barra: 18 mm x 7 mm
Força máxima: 4000 N



Modelo MM

Barra: 18 mm x 7 mm
Força máxima: 4000 N





Modelo	Código					Preço
	01020	20 cm	7 cm	5,7 cm	1,36	17,00
	01025	25 cm	7 cm	5,7 cm	1,81	18,50
	01030	30 cm	7 cm	5,7 cm	2,61	20,00
	02020	20 cm	7 cm	5,7 cm	1,36	18,00
	02025	25 cm	7 cm	5,7 cm	1,81	19,00
	02030	30 cm	7 cm	5,7 cm	2,61	20,00

GRAMPOS DE ÊMBOLO



- Cabeças em ferro fundido nodular; • Barra de aço laminado de alta resistência (90 kg/mm²); • Freio antideslizante na cabeça móvel; • Barra com tratamento superficial antioxidante; • Cabeças com pintura Epoxy.

Modelo	Código					Preço	
Modelo E <div style="border: 1px solid black; padding: 2px; width: fit-content; margin-top: 5px;"> Barra: 30 mm x 8 mm Força máxima: 9000 N </div>		03020	20 cm	8,5 cm	7 cm	1,2	27,00
		03030	30 cm	8,5 cm	7 cm	1,4	30,00
Modelo F <div style="border: 1px solid black; padding: 2px; width: fit-content; margin-top: 5px;"> Barra: 35 mm x 8 mm Força máxima: 9000 N </div>		04040	40 cm	12 cm	10,5 cm	2,2	37,00
		04060	60 cm	12 cm	10,5 cm	2,6	43,00
		04080	80 cm	12 cm	10,5 cm	3	50,00
		04100	100 cm	12 cm	10,5 cm	3,4	56,00
		04150	150 cm	12 cm	10,5 cm	4,4	71,00
Modelo R <div style="border: 1px solid black; padding: 2px; width: fit-content; margin-top: 5px;"> Barra: 40 mm x 10 mm Força máxima: 10000 N </div>		05040	40 cm	15 cm	12,5 cm	3,4	61,00
		05050	50 cm	15 cm	12,5 cm	3,7	64,00
		05060	60 cm	15 cm	12,5 cm	4	67,00
		05080	80 cm	15 cm	12,5 cm	4,6	73,00
		05100	100 cm	15 cm	12,5 cm	5,2	79,00
		05120	120 cm	15 cm	12,5 cm	5,8	84,00
		05150	150 cm	15 cm	12,5 cm	6,7	91,00
Modelo S <div style="border: 1px solid black; padding: 2px; width: fit-content; margin-top: 5px;"> Barra: 40 mm x 10 mm Força máxima: 7000 N </div>		15030	30 cm	22 cm	20,5 cm	3,8	103,00
		15040	40 cm	22 cm	20,5 cm	4,1	107,00
		15060	60 cm	22 cm	20,5 cm	4,7	115,00
		15080	80 cm	22 cm	20,5 cm	5,3	123,00
Modelo H <div style="border: 1px solid black; padding: 2px; width: fit-content; margin-top: 5px;"> Barra: 40 mm x 10 mm Força máxima: 25000 N </div>		23150	150 cm	6 cm		7,0	107,00
		23175	175 cm	6 cm		7,8	115,00
		23200	200 cm	6 cm		8,5	125,00
		23250	250 cm	6 cm		10,0	143,00
Designação	Código	Dimensões				Preço	
Protetores em PVC 	24010	6,5 cm x 4,5 cm Adequados para os modelos: Maxi, E, F, R e S				0,80	

**GRAMPOS DE APERTO
CINTA DE APERTO**

Modelo	Código				Preço
Modelo de Madeira Barra: 20 mm x 5 mm	25020	20 cm	11 cm	0,43	23,00
	25030	30 cm	11 cm	0,51	25,00
	25040	40 cm	11 cm	0,60	27,00
	25060	60 cm	11 cm	0,74	32,00
	25080	80 cm	11 cm	0,93	37,00

Modelo	Força Máxima	Barra (mm)	Código				Preço
Grampo rápido Modelo PAL	3500 N	19,5x9,5	30620	20 cm	10 cm	1,13	80,00
	5000 N	25x12	30630	30 cm	14 cm	2,26	95,00
	5000 N	25x12	30640	40 cm	14 cm	2,44	115,00

Modelo	Código				Preço
Grampo rápido Modelo EXTRA QUICK-PIHER Reversível com um só clic. Fácil de usar com uma só mão. Força máxima: 1500 N	52615	15 cm	8 cm	0,65	28,00
	52630	30 cm	8 cm	0,76	32,00
	52645	45 cm	8 cm	0,88	34,00
	52660	60 cm	8 cm	1	36,00
	52690	90 cm	8 cm	1,24	50,00
	52625	125 cm	8 cm	1,74	65,00

Modelo	Modelo	Código				Preço
Modelo GC Grampo em chapa estampada.	GC-3	07004	3 cm	2,5 cm	0,07	5,50
	GC-5	07005	5 cm	3 cm	0,10	6,00
	GC-7	07007	7 cm	7 cm	0,30	7,50

CINTA DE APERTO

- Até 800 kg de pressão;
- Com quatro ângulos metálicos para formas quadradas e retangulares;
- Protetores de cantos P.E.H.B.;
- Comprimento da cinta: 5 m.

Designação	Código	Preço
Cinta de aperto Multiusos	30013	25,00

TORNO DE BANCADA GUIA QUADRADA

PIHER

Caraterísticas:

- Fabricado em aço forjado; • Guia quadrada ajustável; • Mordentes permutáveis em aço temperado; • Base de bigorna; • Inclui mordanças de alumínio magnetizadas.

Designação	Código	A	B	C		Preço	
Torno de bancada Guia quadrada		55100	10 cm	6,5 cm	10,5 cm	6,35	180,00
		55125	12,5 cm	8 cm	13 cm	11,74	220,00
		55150	15 cm	10 cm	16,5 cm	19,00	410,00

ESQUADROS MAGNÉTICOS

PIHER

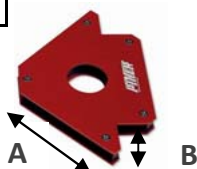

Caraterísticas:

- Capacidade de 45° e 90°; • Para uso industrial; • Fabricado com chapas de aço de 2,5mm; • Ímã protegido e permanente de ferrite.

Modelo	Código				Preço	
Modelo Q1		29003	8,5 cm	1,5 cm	0,3	16,00
Modelo Q2		29004	11 cm	1,8 cm	0,65	25,00
Modelo Q3		29005	14 cm	2 cm	1,2	40,00



MASSA MAGNÉTICA PARA SOLDADURA

PIHER



Caraterísticas:

- Peça de contacto inteiramente em latão;
- Para uso industrial;
- Ímã permanente de ferrite.

Modelo	Código	Modelo				Preço
Massa Magnética	29006	MG1	6 cm	150 A	0,18	19,00
	29007	MG2	9 cm	300 A	0,55	35,00

PINÇAS E FECHO DE APERTO RÁPIDO

PINÇAS DE PRESSÃO PROGRESSIVA



Caraterísticas:

- Mordalha ajustável de ângulo variável
- Punho de agarre ergonómico e antideslizante
- Material de alta resistência;
- Fácil de soltar com um só dedo.

Designação	Código				Preço
Pinças de pressão progressiva	52201	5 cm	5 cm	0,19	9,50
	52202	7,5 cm	7,5 cm	0,26	11,00

PINÇAS DE PLÁSTICO - AJUSTÁVEIS



Caraterísticas:

- Força de pressão ajustável por parafuso;
- Mordentes em PE de ângulo ajustável;
- Corpo em nylon e fibra de vidro;
- Mola temperada extra-resistente.

Designação	Código				Pressão máxima	Preço
Pinças de plástico ajustáveis	30910	3 cm	3,5 cm	0,09	20 kg	5,00
	30911	5 cm	6 cm	0,13	18 kg	7,10

PINÇAS METÁLICAS

Caraterísticas:

- Pinças de montagem multiusos.

Com isolamento



Sem isolamento



Designação	Código				Preço
Pinças metálicas com isolamento	30007	3,5 cm	3 cm	0,08	4,00
	30008	5,5 cm	4,5 cm	0,17	7,20
	30009	8,5 cm	7 cm	0,40	11,50
Pinças metálicas sem isolamento	57025	2,5 cm	3 cm	0,05	2,40
	57050	5 cm	5 cm	0,16	3,50

FECHO DE APERTO RÁPIDO - GANCHO

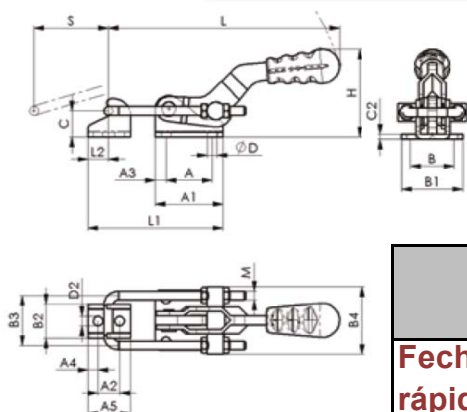

Caraterísticas:

- Furação compatível com as marcas de referência.

Designação	Código	A	B	C	H	Preço
Fecho de aperto rápido - gancho M4	56200	16	19	12	32	35,00

VENTOSAS

PHER

VENTOSA PROFLAT



Caraterísticas:

- Punho de plástico reforçado ABS;
- Bomba de plástico reforçado ABS com indicador de perigo;
- Válvula para descompressão instantânea com protetor;
- Caixa e protetor incluídos.

capacidade de carga



PHER

100 kg

Designação	Código	∅	Kg	Preço
Ventosa PROFLAT	30131	20 cm	1,56	190,00

VENTOSAS DE PLÁSTICO



VEN-1
para uso com
uma só mão



VEN-2

Caraterísticas:

- Corpo fabricado em plástico reforçado ABS;
- Cabeças flutuantes entre eixos e alojamento central para cinta de nylon;
- Protetores incluídos.

capacidade de carga



PHER

20 kg



GS

10 kg

30 kg

Designação	Código	∅	Kg	Preço
Ventosa simples VEN-1	30024	12,3 cm	0,3	25,00
Ventosa dupla VEN-2	30025	11,7 cm	0,6	62,00

VENTOSAS DE ALUMÍNIO



Venal 1



Venal 2



Venal 3



Caraterísticas:

- Corpo fabricado em liga de alumínio de alta densidade;
- Protetores incluídos.

capacidade de carga



PHER

40 kg



GS

15 kg

60 kg

25 kg

100 kg

35 kg

Designação	Código	∅	Kg	Preço
Venal 1	30026	12,3 cm	0,47	53,00
Venal 2	30027	12,3 cm	0,94	80,00
Venal 3	30028	12,3 cm	1,34	116,00

TRANSPORTADOR DE PAINÉIS



Máx. 6 cm

Capacidade de carga:
75 kg



Caraterísticas:

- Para mover painéis armazenados;
- Para transportar madeira, plástico, metais livres de óleo e muito mais;

Designação	Código			Preço
Transportador de painéis	57103	6 cm	0,98	90,00

TRANSPORTADOR ESPECIAL PARA VIDRO

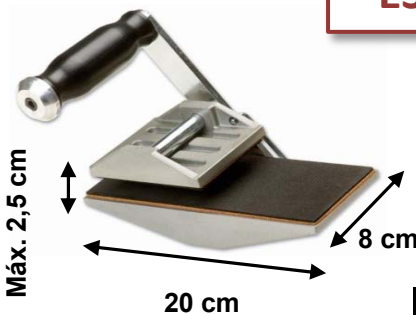

Máx. 2,5 cm

20 cm

8 cm

Capacidade de carga:
80 kg



Caraterísticas:

- Corpo fabricado em alumínio de alta densidade;
- Borracha antideslizante sobre cortiça nas

Designação	Código			Preço
Transportador especial para vidro	30104	2,5 cm	1	200,00

TRANSPORTADOR DE PLÁSTICO



35,5 cm

7 cm

16,4 cm

Capacidade de carga:
100 kg



Caraterísticas:

- Corpo fabricado em plástico PP;
- Espessura máxima a transportar: 3 cm.

Designação	Código		Preço
Transportador de plástico	30105	0,45	20,00

NÍVEIS DE BOLHA DE AR



Ref.ª 244/M PROFISSIONAL - AJUSTÁVEL - MAGNÉTICO



Caraterísticas:

- Nível em perfil de alumínio;
- Pintado com cor amarela (RAL 1007);
- Com base magnética;
- Ampola central ajustável com parafusos
- Precisão: 0,5 mm por 1 m.

Ref.ª	Tamanho	N.º Ampolas		Preço
244/M-40	400 mm	3	10	25,00
244/M-60	600 mm	3	10	31,00
244/M-100	1000 mm	3	10	42,00
243/M-200	2000 mm	3	10	75,00

Ref.ª 230 BRICOLAGE





Caraterísticas:

- Nível em perfil de alumínio;
- Pintado com cor amarela (RAL 1007).

Ref.ª	Tamanho	N.º Ampolas		Preço
230/40	400 mm	3	10	5,70
230/60	600 mm	3	10	7,00
230/80	800 mm	3	10	8,50
230/100	1000 mm	3	10	10,00

ACESSÓRIOS PARA A CONSTRUÇÃO



Produto	Caraterísticas	Ref.ª	Tamanho		Preço
FITA SINALIZADORA  DUPLA FACE	Fita sinalizadora de duas faces, vermelho e branco. Ideal para delimitar zonas protegidas ou perigosas como competições desportivas, obras, escavações ou objetos perigosos . A fita sinalizadora é fornecida numa embalagem cómoda de cartão, útil também para o desenrolar da fita.	700	200m x 70mm	36	5,20
FIO TIRA-LINHAS  RECARREGÁVEL	Tira-linhas de fio resistente; recarregável; corpo em material bicomponente: ABS (de cor amarela) + borracha (de cor negra); fio de poliéster com 30 metros de comprimento; manivela para rebobinar e bloquear o fio; gancho para fixação do fio. Fornecido com um frasco de pó azul de 115 gramas.	279	30 m	1	7,40

**INSTRUMENTOS DE MEDIÇÃO
- FITAS MÉTRICAS -**



Modelo	Caraterísticas	Ref. ^a	Tamanho		Preço
 PROFISSIONAL	Fita métrica metálica profissional com corpo resistente e ergonómico em material bicomponente: ABS e borracha. Bloqueio automático da fita no comprimento desejado. Amortecedor de fim de curso da fita; gancho móvel para medições interiores. Homologado MID classe de precisão II.	174316GVC	3m x 16mm	12	2,70
		1741025GVC	10m x 25mm	6	9,30
 PROFISSIONAL	Fita métrica metálica profissional com corpo bi-componente em ABS amarelo recuberto por borracha negra antichoque. Novo desenho compacto e ergonómico. Fita de aço temperado, esmaltado e pintado com duplo raio de curvatura. Mecanismo de retorno metálico. Triplo rebite. Homologado classe de precisão II de acordo com a norma MID.	172519GVC	5m x 19mm	12	8,40
		172525GVC	5m x 25mm	12	10,40
	Fita métrica com caixa de material plástico (ABS) antichoque. Manivela dobrável. Fita em fibra de vidro. Homologado classe de precisão III de acordo com a norma MID.	301/20NV-SPA	20m x 15mm	1	10,00
		301/30NV-SPA	30m x 15mm	1	14,00
	Fita métrica com carcaça de material plástico antichoque(ABS) e pega em borracha antideslizante. Ponta para a fixação ao solo. Rebobinagem rápida. Fita lavável . Homologado de acordo com a norma MID.	311/30-FRA	30m x 13mm	1	33,00
		311/50-FRA	50m x 13mm	1	42,00

**INSTRUMENTOS DE MEDIÇÃO RIGOROSA
- PAQUÍMETRO -**



**Ref.^a 400
PAQUÍMETRO**

Modelo	Caraterísticas	Ref. ^a	Tamanho		Preço
	<ul style="list-style-type: none"> • Instrumento de precisão: 0,02 mm; • Construído em aço inox temperado; • Bloqueio por patilha; • Alcance 0-150 mm ; • Pontas com 40 mm; • Com estojo individual em ABS. 	400	150 mm	10	19,30

**FERRAMENTAS DE CORTE
- X-ATOS -**



Modelo	Caraterísticas	Ref. ^a	Tamanho		Preço
	X-ato com formato anatómico de material plástico bi-componente. Paragem manual da lâmina. Lâmina de substituição: ref. ^a 620.	617B	18 mm	24	3,10
	X-ato com formato anatómico de material plástico bi-componente. Paragem automática da lâmina. Lâmina de substituição: ref. ^a 620.	618B-BL	18 mm	24	3,30
	X-ato com formato anatómico de material plástico. Paragem automática da lâmina. Lâmina de substituição: ref. ^a 620.	612-BL	18 mm	24	1,00
	Lâmina de substituição: 0,5 mm de espessura x 18 mm de largura.	620	18 mm	10x10	1,50 €/10

**ESQUADROS
PARA CARPINTEIROS**



Modelo	Caraterísticas	Ref. ^a	Tamanho		Preço
ESQUADRO COM CEPO 	Esquadros para carpinteiros com cepo em alumínio pintado e retificado em todos os lados. Lâmina de aço ao carbono C67 pintado com duas cores (laranja e amarelo). Escala milimetrada gravada sobre os dois lados da lâmina.	270/35	350 mm	12	11,20
ESQUADRO PLANO 	Esquadro rígido em aço para carpinteiros. Secção 30mm x 5mm. Cor amarela (RAL 1007)	273/80	800 mm	5	18,00

INOVAÇÃO EM INSTRUMENTOS DE MEDIÇÃO



LASERS DE LINHA E DE CRUZ



MEDIDORES DE DISTÂNCIAS



**INDICADORES DE NIVELAMENTO E
INCLINAÇÃO**



MEDIDORES DE TEMPERATURA



**MEDIDORES DE GRANDEZAS
ELÉTRICAS**



ACESSÓRIOS E SOFTWARE

EasyCross-Laser Green Set

Laserliner®
Innovation in Tools

LASER VERDE DE LINHAS CRUZADAS COM TRANSMISSÃO DE ALTURAS E ORIENTAÇÃO



CARATERÍSTICAS:

- Tecnologia de laser verde
- Cruz de laser verde extremamente brilhante na frente, o resultado é uma alta qualidade de linhas: limpas, claras e, portanto, altamente visível.
- Excelente para alinhar azulejos, papel de parede, quadros, etc.
- Nível Automático: nivelamento automático por meio de sistema pendular com amortecimento magnético.
- Modo de inclinação adicional para nivelar superfícies inclinadas
- Nivelamento Out-Of: o dispositivo indica que está fora da faixa de nivelamento através de sinais ópticos.
- Bloqueio de transporte: o bloqueio do pêndulo protege o aparelho durante o transporte.
- Tecnologia laser verde com uma gama de temperatura de 0°C.a 50°C.
- Consola ajustável em altura com roscas de 1/4" e 5/8" no tripé e ímanes.



Fornecido com suporte de parede + pilhas

Ref. ^a		Preço
081.081A	1	150,00

CompactPlane-Laser 3G Set 150

Laserliner®
Innovation in Tools

LASER VERDE TRIDIMENSIONAL COM UM CÍRCULO LASER HORIZONTAL E DOIS VERTICAIS, TRIPÉ COMPACTO DE 150 cm E PORTA DIGITAL CONNECTION



CARATERÍSTICAS:

- Este laser tridimensional projeta um círculo de laser horizontal e dois verticais, ideal para o alinhamento exato de objetos.
- A tecnologia laser verde oferece alta visibilidade mesmo em condições de pouca luz.
- A função de inclinação manual permite criar facilmente planos inclinados.
- Com a porta Digital Connection e a aplicação Commander gratuita, o laser pode ser convenientemente controlado remotamente.
- Graças à redução efetiva de erros de medição com a função Tilt, o dispositivo oferece alta confiabilidade de medição.
- O tripé de alumínio leve e compacto possui elevação da manivela e pernas extensíveis.
- O modo de recetor portátil integrado permite também o uso com um recetor a laser opcional, ideal para aplicações externas e longas distâncias.
- Um bloqueio oscilante garante uma boa proteção durante o transporte.



Fornecido com bolsa de transporte

Ref. ^a		Preço
036.299A	1	490,00

FixPod 155 cm

Laserliner®
Innovation in Tools

TRIPÉ PARA AS SÉRIES SUPERCROSS-LASER, SMARTCROSS-LASER, COMPACTCUBE-LASER, SMARTVISION-LASER, SMARTLINE-LASER 360° E PARA OS DISTANCIÓMETROS LASER



CARATERÍSTICAS:

- Conexão de tripé de 1/4"
- Cabeça de três vias
- Elevador de manivela e pernas multi-extensão
- Pontas de aço e borracha para diferentes bases de apoio

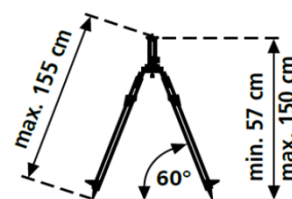

Fornecido com bolsa de transporte

Ref. ^a		Preço
090.132A	1	120,00

VarioStand L 120 cm

Laserliner®
Innovation in Tools

TRIPÉ DE MANIVELA VARIÁVEL COM ADAPTADOR



CARATERÍSTICAS:

- Para fixação de instrumentos com roscas de 1/4" e 5/8"
- A combinação especial de pontas (borracha-aço) permite a fixação do tripé em diferentes bases.
- Elevador de manivela e pernas extensíveis

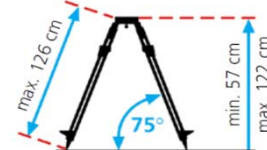
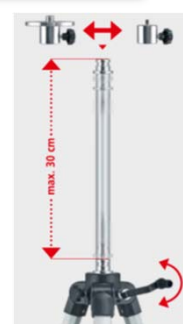

Fornecido com adaptador para roscas de 1/4" e 5/8"

Ref. ^a		Preço
080.29A	1	100,00

LaserRange-Master i5

Laserliner®
Innovation in Tools

DISTANCIÓMETRO LASER – COM FUNÇÃO DE ÂNGULO



CARATERÍSTICAS:

- Medição exata com laser: desta forma, a medição pode ser determinada com exatidão
- A função de área e volume permite detetar volumes. Assim, é possível calcular rapidamente, por exemplo, a quantidade de material necessária
- Alta precisão de medição até 50 m: $\pm 1,5$ mm
- Medição contínua para min./máx.
- Nível de bolha digital
- Calibração do sensor de inclinação
- Sensor de inclinação de 360° para determinar a distância horizontal e vertical
- Memória de valores medidos com 50 entradas
- 2 níveis de medição comutáveis para frente e para trás
- Visor LC colorido de 4 linhas com iluminação
- Carcaça ergonómica sólida com proteção de borracha



Fornecido com bolsa de transporte e pilhas

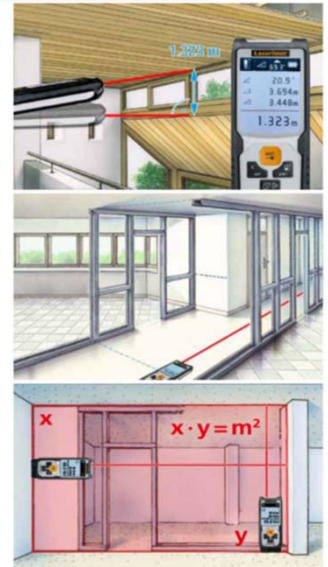

Ref. ^a		Preço
080.835A	1	160,00

LaserRange-Master i3

Laserliner®
Innovation in Tools

DISTANCIÓMETRO LASER – FÁCIL MANEJO



CARATERÍSTICAS:

- Medição exata com luz laser: desta forma, a medição pode ser determinada com exatidão
- A função de área e volume permite detetar volumes. Assim, é possível calcular rapidamente, por exemplo, a quantidade de material necessária
- Alta precisão de medição até 30 m: ± 2 mm
- Faixa de medição interna: de 0,3 m a 30 m
- 2 níveis de medição comutáveis para a frente e para trás
- Função Min/Max para determinar secções diagonais, horizontais e verticais
- Visor VTN, 2 linhas, com iluminação
- Modelo pequeno e compacto – adequado para todos os tipos de caixas de ferramentas
- Carcaça ergonómica sólida com proteção de borracha



Fornecido com bolsa de transporte e pilhas



Ref. ^a		Preço
080.830A	1	120,00

RollPilot S12

Laserliner®
Innovation in Tools

HODÓMETRO PARA APLICAÇÃO EM LINHAS RETAS E CURVAS.



CARACTERÍSTICAS:

- Este distanciômetro mecânico fornece dados exatos em todas as medições até 9.999,9 m.
- Visor grande e de fácil leitura com escala de precisão adicional (1 – 9 cm) para medições exatas.
- Função de adição quando a roda avança e subtração quando retrocede.
- O indicador móvel indica as posições inicial e final exatas.
- Modelo dobrável com capa para fácil transporte.
- Acesso rápido à fixação e posição zero, localizada diretamente no punho.
- Acionamento do contador por cardan, sem desgaste.
- Roda de medição com 1 metro de perímetro.

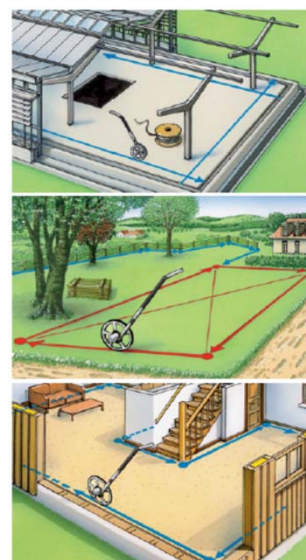

Fornecido com bolsa de transporte

Ref. ^a		Preço
075.005A	1	200,00

DigiLevel Plus

Laserliner®
Innovation in Tools

NÍVEIS DE BOLHA ELETRÔNICOS DIGITAIS: EXATOS E MUITO MANEJÁVEIS



CARACTERÍSTICAS:

- Nível de bolha adequado para tudo: nível de bolha inteligente com visor de ângulo vertical e horizontal.
- Função de referência para transferir ângulos.
- Unidades disponíveis: ° graus, %, mm/m.
- Aplicação ideal graças ao AutoSound: A posição horizontal, vertical e 45° é acompanhada por um sinal acústico, muito prático para alinhar objetos.
- FlipDisplay: Ao fazer medições aéreas, a tela vira automaticamente. Desta forma, o display iluminado pode ser lido em qualquer situação.
- Função de calibração para recalibrar o sensor e aumentar a segurança das medições.
- Visor iluminado.
- Nível de bolha vertical e horizontal.
- Superfícies de medição fresadas.
- Poderoso íman de fixação.



Fornecido com bolsa de transporte e pilhas



Ref. ^a	Tamanho		Preço
081.249A	25 cm	1	80,00
081.250A	40 cm	1	92,00
081.251A	60 cm	1	165,00

ArcoMaster

Laserliner®
Innovation in Tools

MEDIDOR DE ÂNGULOS ELETRÔNICO DIGITAL – MEDIR COM PRECISÃO ATÉ AO ÚLTIMO GRAU

CARATERÍSTICAS:

- Determinar com precisão o ângulo interior ou exterior de 0-220°: durante a medição de tetos inclinados, o encaixe de móveis ou janelas em cantos e rebordos.
- Garra de medição extraível e articulada de ambos os lados para a medição de ângulos em locais de difícil acesso.
 - Caixa de alumínio robusta
 - Nível de bolha vertical e horizontal
 - Um visor LCD iluminado no lado frontal e um no lado traseiro permitem trabalhar de ambos os lados.
 - Ambos os visores rodam, bastando premir o botão FlipDisplay
 - Função AutoShut Off
 - Auto-Hold: para trabalhos sem contacto visual com o visor LCD.
 - A bissetriz é indicada ao premir o botão, também no modo Hold; ideal para cortes em meia esquadria.

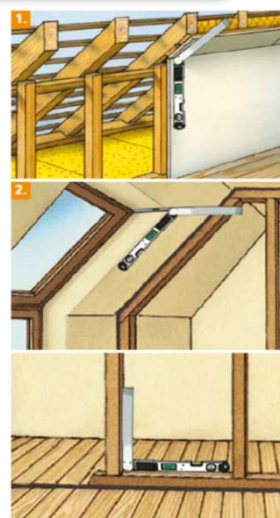

Fornecido com bolsa de transporte e pilhas

Ref. ^a	Tamanho		Preço
075.130A	40 cm	1	270,00
075.131A	60 cm	1	390,00

DigiLevel Pro 40 DigiLevel Pro 60

Laserliner®
Innovation in Tools

NÍVEIS DE BOLHA ELETRÔNICOS DIGITAIS

CARATERÍSTICAS:

- O nível de bolha digital é ideal para o alinhamento preciso de superfícies inclinadas, possui uma interface Bluetooth e é à prova d'água.
- A sua operação é muito fácil graças à função de orientação acústica e gradientes padrão definidos para aplicações típicas.
- Alinhamento exato de superfícies inclinadas.
- Medições aéreas confortáveis graças ao ecrã que gira 180° automaticamente.
- Trabalho com as mãos livres em construções metálicas graças aos poderosos ímanes.
- Inclinações padrão para inclinação de telhado, rampas, tubos de drenagem...
- Calibração: precisão permanente por medição inversa.
- Guia acústico com 3 tons de sinal diferentes.
- As unidades de medida podem ser alteradas.
- Interface Bluetooth para uso com o aplicativo MeasureNote.
- Visor iluminado com indicador de direção.
- Perfil de alumínio extremamente rígido com superfície de medição fresada.
- À Prova de salpicos de água.
- Laser por pontos integrado para extensão ótica.



Fornecido com bolsa de transporte e pilhas

Ref. ^a	Tamanho		Preço
081.270A	40 cm	1	230,00
081.271A	60 cm	1	300,00

ThermoSpot Pocket

Laserliner®
Innovation in Tools

MEDIDOR DE TEMPERATURA



CARATERÍSTICAS:

- Dispositivo de medição de temperatura por infravermelhos, sem contacto.
- Medição de temperatura em locais de difícil acesso ou zonas de medição perigosas.
- Exibição mín./máx.
- Função de retenção.
- Emissividade 0,95.



Fornecido com pilhas

Ref. ^a		Preço
082.440A	1	70,00

ActiveFinder

Laserliner®
Innovation in Tools

SEGURANÇA AO TRABALHAR EM CABOS ELÉTRICOS – FORMATO MUITO PRÁTICO



CARATERÍSTICAS:

- Detecção sem contacto de cabos energizados de 24 VCA a 1000 VCA
- Localização de tensões elétricas em cabos, tomadas, porta-lâmpadas e fusíveis
- Busca por quebras de linha em fios e cabos
- CAT III - 1000V – adequado para medições em instalações prediais completas
- Sensibilidade muito alta para rastreamento de linha em grandes profundidades (Zoom)
- Sinalização de tensão elétrica por LED de alta visibilidade
- Lanterna integrada muito brilhante, com botão liga e desliga individual
- Formato pequeno com um prático clipe de bolso, adequado para bolsos de camisa ou todos os tipos de caixas porta-ferramentas
- Estojo robusto de qualidade à prova de choque



Fornecido com pilhas

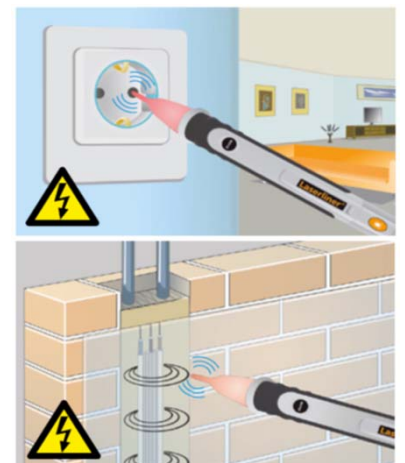

Ref. ^a		Preço
083.010A	1	25,00

ActiveMaster

Laserliner®
Innovation in Tools

MANEJÁVEL, RÁPIDO E SIMPLES PARA CONTROLO DA TENSÃO E DA CORRENTE ELÉTRICA



CARATERÍSTICAS:

- Verificador de tensão rápido e seguro, com as tensões nominais mais importantes.
- Teste automático de corrente alternada (AC) e direta (DC).
- Com mudança automática de gama e função para verificação e medição direta.
- Testes monofásicos e trifásicos com indicação de direção de fase.
- Verificação de fase num polo.
- Verificação automática de corrente com sinal acústico.
- CAT III - 1000V – adequado para medições em instalações prediais completas.
- Autoteste de segurança (aviso AC) a partir de 50 V, em modo de emergência também funciona sem bateria.
- Iluminação integrada do ponto de medição por meio de LEDs muito brilhantes.
- Carcaça robusta e prática com fixação para distância da ponta de teste (para tomadas padrão europeias).

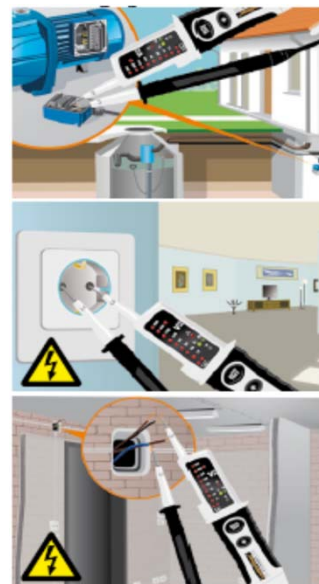

Función Auto-Test

Fornecido com tampas de proteção e pilhas

Ref. ^a		Preço
083.021A	1	120,00

MultiClamp-Meter Pro

Laserliner®
Innovation in Tools

PINÇA PARA A MEDIÇÃO PROFISSIONAL DE CORRENTE E TENSÃO, COM MEDIÇÃO DE VALOR EFETIVO REAL



Pantalla iluminada

Rueda de funciones de fácil manejo

Gran amplitud de la pinza

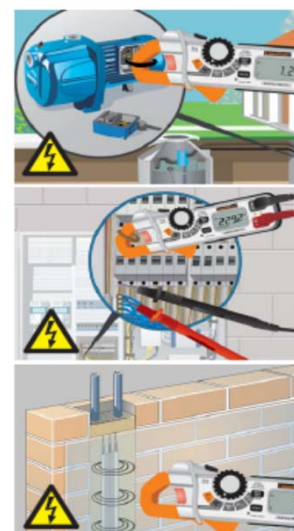

CARATERÍSTICAS:

- Medição rápida e segura em todos os circuitos de corrente fechados;
- Medição de corrente contínua e alternada com determinação real do valor RMS (True RMS);
- Verificação automática de passagem com sinal acústico;
- Resultados precisos na medição de corrente contínua por ajuste de zero DC;
- Medição automática de diodos com tensão de corrente de até 1,5V;
- Função Peak-HOLD para determinar correntes de conexão breves;
- Alta resolução para determinar com precisão a corrente, tensão e resistência;
- Indicador de tensão sem contato integrado, para deteção rápida de peças condutoras;
- CAT III - 600 V – adequado para medições em instalações de edifícios inteiros;
- Iluminação do ponto de medição integrada através de LED de alta intensidade;
- Função MIN/MAX para determinar magnitudes variáveis de medição;
- Visor LC grande e fácil de ler com luz de fundo e indicador de barógrafo.



Fornecido com pilhas e cabos de medição

Ref. ^a		Preço
083.040A	1	200,00

MultiMeter-Compact

Laserliner®
Innovation in Tools

MULTÍMETRO UNIVERSAL COMPACTO, COM TODAS AS FUNÇÕES PARA USO PROFISSIONAL



CARACTERÍSTICAS:

- Medição rápida e precisa de tensão, corrente, resistência, capacitância, frequência e fator de pulso;
- Com mudança automática de função e seleção manual da mesma;
- Verificação automática de passagem com sinal acústico;
- Função de teste de diodo para verificações de operação e polaridade;
- Indicador de tensão sem contato integrado, com sinal acústico, visual e de vibração;
- Alta resolução de medição para determinação precisa de várias variáveis de medição;
- Função de Data HOLD para medir em pontos de difícil acesso;
- CAT III - 1000V – adequado para medições em instalações de edifícios inteiros;
- Visor LC grande e fácil de ler com luz de fundo e indicador analógico;
- Carcaça compacta à prova de choque com pé de apoio, suporte e seletor suave.

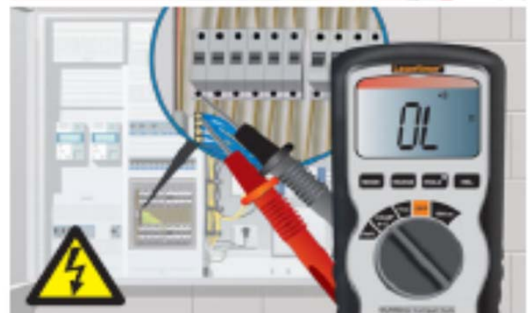

Pantalla de gran tamaño, con iluminación

Botón de funciones de fácil manejo

Alarma de vibración



Fornecido com pilhas e cabos de medição

Ref. ^a		Preço
083.034A	1	120,00

FERRAMENTAS, INSTRUMENTOS E UTENSÍLIOS
PARA A CONSTRUÇÃO
- 4K5 -



NÍVEIS DE BOLHA DE AR • INSTRUMENTOS DE MEDIÇÃO • ACESSÓRIOS PARA MARCAÇÃO

FERRAMENTAS DE CORTE • X-ATOS • TESOURAS • ACESSÓRIOS DE ILUMINAÇÃO



NÍVEIS DE BOLHA DE AR

4K5

BETTER EQUIPMENT

4K5 SÉRIE ZE
NÍVEL DE BOLHA DE AR COM PERFIL RETANGULAR DE ALTA QUALIDADE, EXATO E DE FÁCIL LEITURA

- Leitura fácil através da lente de aumento no nível de bolha horizontal em bloco de vidro acrílico e de um visor adicional no nível de bolha vertical em bloco de vidro acrílico;
- Superfícies de medição finamente fresadas para o alinhamento exato;
- Elevada precisão de medição em medições na posição normal e invertida;
- Caixa de alumínio robusta com espessura de parede resistente;
- Grande estabilidade devido a alma contínua do perfil/nível de bolha sem entalhe para o nível de bolha;
- Aplicação confortável com pegas ergonómicas almofadadas;
- Boa proteção do perfil com capas terminais em borracha amortecedoras de choque em polipropileno;
- Posição segura devido aos elementos antideslize em borracha para a parede.

Ref. ^a	Tamanho		Preço
603.100-60	60 cm	1	68,00
603.100-80	80 cm	1	74,00
603.100-100	100 cm	1	84,00
603.100-180	180 cm	1	150,00
603.100-200	200 cm	1	170,00

NÍVEIS DE BOLHA DE AR



4K5 SÉRIE GE

NÍVEL DE BOLHA DE AR DE ALTA QUALIDADE E FÁCIL LEITURA PARA O PROFISSIONAL DE CONSTRUÇÃO

Profissional



- Leitura fácil através da lente de aumento no nível de bolha horizontal em bloco de vidro acrílico e de um visor adicional no nível de bolha vertical em bloco de vidro acrílico;
- Elevada precisão de medição em medições na posição normal e invertida;
- Boa proteção do perfil com capas terminais em borracha amortecedoras de choque em polipropileno;
- Posição segura devido aos elementos antideslize em borracha para a parede.

Ref. ^a	Tamanho		Preço
603.102-40	40 cm	1	21,00
603.102-50	50 cm	1	23,00
603.102-60	60 cm	1	26,00
603.102-80	80 cm	1	31,00
603.102-100	100 cm	1	44,00
603.102-150	150 cm	1	48,00

4K5 SÉRIE GEM

NÍVEL DE BOLHA DE AR MAGNÉTICO DE ALTA QUALIDADE E FÁCIL LEITURA PARA O PROFISSIONAL DE CONSTRUÇÃO

Profissional

Magnético



- Características do produto como série GE;
- Mãos livres para trabalhar em construções de metal devido à instalação com ímãs de terras raras.

Ref. ^a	Tamanho		Preço
603.102-40M	40 cm	1	26,00
603.102-60M	60 cm	1	31,00
603.102-100M	100 cm	1	49,00

NÍVEIS DE BOLHA DE AR



4K5 SÉRIE ME

NÍVEL DE BOLHA DE AR STANDARD LEVE, ROBUSTO E EXATO



- Alinhamento horizontal e vertical de objetos;
- Perfil de Alumínio leve e robusto com espessura de parede resistente;
- Boa proteção do perfil devido a capas terminais em borracha

Profissional

Ref. ^a	Tamanho		Preço
603.103-40	40 cm	1	17,00
603.103-60	60 cm	1	20,00
603.103-80	80 cm	1	25,00

4K5 EL

NÍVEL DE BOLHA DE AR ELÉTRICO PARA O POSICIONAMENTO IDEAL DE TOMADAS E INTERRUPTORES

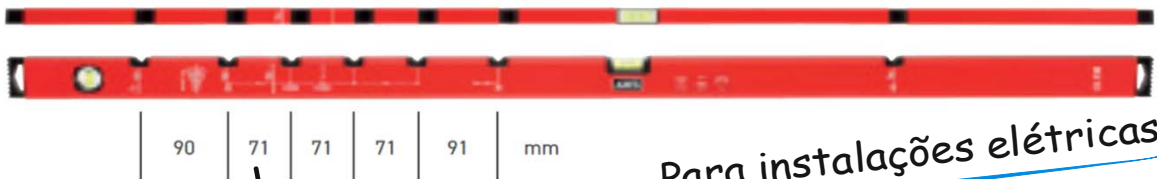

Profissional

Para instalações elétricas

- Determinação exata de distâncias entre tomadas com a ajuda de marcação em intervalos..

Ref. ^a	Tamanho		Preço
603.106-130	130 cm	1	75,00

4K5 SÉRIE DR

NÍVEL DE BOLHA DE AR PARA CONSTRUÇÃO A SECO PARA O ALINHAMENTO E A INSTALAÇÃO IDEAIS DE VIGAS DE PAREDE DE METAL

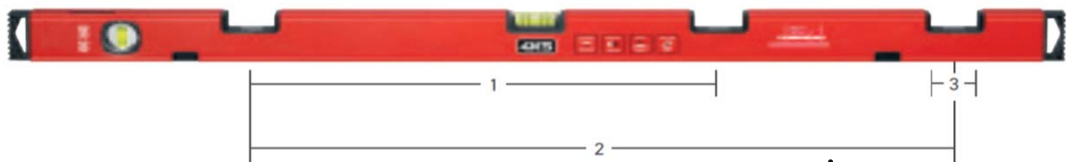

Profissional

Para trabalhos com Pladur

- Entalhes com ímanes de terras raras para o alinhamento e a fixação de vigas de parede de metal;
- Dois níveis de bolha em bloco de vidro acrílico resistentes ao impacto;
- Visor adicional para a leitura fácil do nível de bolha vertical em bloco de vidro acrílico;
- Marcação prática de inclinação de 2 % no nível de bolha horizontal em bloco de vidro acrílico;
- Superfície de medição fresada para o alinhamento exato;
- Mãos livres para trabalhar em construções de metal devido à instalação com ímanes de terras raras;
- Boa proteção do perfil com capas terminais em borracha resistentes ao impacto e amortecedoras de choque.

Ref. ^a	Tamanho		Preço
773B-90	90 cm	1	75,00

NÍVEIS DE BOLHA DE AR

4K5

BETTER EQUIPMENT

4K5 IN
NÍVEL DE BOLHA DE AR PARA INSTALADORES COM ENTALHES EM DISTÂNCIAS NORMALIZADAS PARA MEDIDAS DE INSTALAÇÃO USUAIS

- Dois níveis de bolha em bloco de vidro acrílico resistentes a choque e rutura;
- Visor adicional para a leitura fácil do nível de bolha vertical em bloco de vidro acrílico;
- Marcação prática de inclinação de 2 % no nível de bolha horizontal em bloco de vidro acrílico;
- Cinco entalhes com distâncias normalizadas para medidas de instalação usuais (montagem de parede/lavatório, ligação para torneira, ligação de água fria/quente);
- Modelo robusto devido ao perfil retangular de alumínio reforçado;
- Boa proteção do perfil devido a capas terminais resistentes ao choque;
- Posição segura devido aos elementos antideslize em borracha para a parede.

Profissional
Para trabalhos com canalizações

Ref. ^a	Tamanho		Preço
603.105-70	70 cm	1	75,00

4K5 HA 10
NÍVEL DE BOLHA PEQUENO

- Construção extremamente compacta, adequada para qualquer bolso de calças e qualquer cinto de ferramentas;
- Perfil em tubo de alumínio leve e estável;
- Nível de bolha em bloco de vidro acrílico resistente ao choque;
- Boa proteção do perfil devido a capas terminais resistentes ao choque.

Profissional
De bolso

Ref. ^a	Tamanho		Preço
603.110-10	10 cm	1	10,00

4K5 TOP
NÍVEL DE BOLHA DE AR PARA CONSTRUÇÃO A SECO PARA O ALINHAMENTO E A INSTALAÇÃO IDEAIS DE VIGAS DE PAREDE DE METAL

- Três níveis de bolha de fácil leitura para o alinhamento de horizontais, verticais e ângulos de 45°;
- Nível de bolha horizontal com leitura possível de três lados devido ao visor adicional;
- Ranhura em V magnética para tubos e canais de cabos;
- Boa proteção do perfil devido a capas terminais em borracha.

Profissional
Para trabalhos com Pladur

Ref. ^a	Tamanho		Preço
603.111	25,5 cm	1	10,00

4K5 RMX 3/5/8

FITA MÉTRICA ROBUSTA COM IMPRESSÃO EM AMBOS OS LADOS COM GANCHO DE EXTREMIDADE MAGNÉTICO

Profissional



Escala revestida a Nylon

Com gancho magnético

Resistente ao choque



- Fita métrica de fácil leitura em qualquer posição com impressão em ambos os lados (horizontal/vertical);
- Gancho magnético na ponta para a instalação em superfícies metálicas;
- O gancho tem uma fixação móvel para medições interiores e exteriores exatas;
- Botão de paragem fácil de usar para fixar a fita;
- Transporte simples com clipe de bolso ou alça;
- A caixa robusta revestida com borracha adapta-se bem à mão;
- Limpeza fácil e rápida.

Ref. ^a	Tamanho		Preço
606.100-3	3 m x 19 mm	1	14,00
606.100-5	5 m x 19 mm	1	19,00
606.100-8	8 m x 25 mm	1	28,00

4K5 LMF30/50

FITA MÉTRICA DE FIBRA DE VIDRO PARA GRANDES DISTÂNCIAS COM GANCHO DE EXTREMIDADE MÓVEL, FIXAÇÃO EFICAZ E CABO ERGONÓMICO



Profissional

- Adequado para medições a grande distância;
- Gancho de extremidade móvel e fixação eficaz;
- Só é necessária uma pessoa para o processo de medição;
- Fita de fibra de vidro com escala contínua de fácil leitura;
- Enrolamento rápido com manivela e transmissão prática 3:1;
- Utilização confortável com o cabo ergonómico.

Fita em fibra de vidro

Ref. ^a	Tamanho		Preço
606.104-30	30 m	1	37,00
606.104-50	50 m	1	45,00

4K5 FR 2X

METRO ARTICULADO ESTÁVEL COM MEDIDOR DE ÂNGULOS INTEGRADO



Profissional

- Perfil de madeira robusto com números e escala bem visíveis;
- Medidor de ângulos integrado para o alinhamento de inclinações definidas;
- As articulações de engate exato, de alta qualidade, evitam imprecisões de medição;
- A pintura resistente protege de humidade e sujidade;
- As capas terminais de metal evitam o desgaste.

Resistente ao desgaste

Ref. ^a	Tamanho		Preço
606.105-2	1 m	1	12,00

ACESSÓRIOS PARA MARCAÇÃO



4K5 DP 100 / 101

MARCADOR MECÂNICO PROFISSIONAL



- Ferramenta de marcação ideal para todo o setor de construção;
- Para traçar em madeira, metal, cerâmica e betão;
- Não é preciso afiar;
- 18 % mais grossas do que minas convencionais de lápis de carpinteiro;
- Conforme a necessidade, basta carregar em cima na tampa e puxar a mina;
- Três minas de substituição;
- Robusto e resistente.

Ref. ^a	Cor		Preço
601.100A	Preto	1	7,50
601.101A	Branco	1	8,50

4K5 ZI 240

JOGO DE LÁPIS DE CARPINTEIRO COM AFIADOR INCLUÍDO



- Cinco lápis de carpinteiro para um traçamento fácil;
- Afiador profissional para todos os lápis de carpinteiro usuais.

Ref. ^a	Tamanho		Preço
601.102A	24 cm	1x5	10,00

FERRAMENTAS DE CORTE



4K5 TK 100

CANIVETE ROBUSTO PARCIALMENTE LISO COM SERRILHA NA LÂMINA



- A lâmina afiada em aço inoxidável possibilita um trabalho exato e um corte preciso;
- Possibilidades de utilização variadas devido à lâmina parcialmente lisa e com serrilha;
- Uso fácil devido ao desbloqueio da lâmina com pressão de botão;
- O bloqueio liner-lock fixa a lâmina na posição aberta;
- Cabo de polímero prático com cavidades ergonômicas para os dedos e orifício para correia integrado;
- Fácil de guardar com clipe para cinto;

Ref. ^a	Tamanho		Preço
600.100A	81 / 203 mm	1	27,00

FERRAMENTAS DE CORTE



4K5 TK 300

X-ATO DOBRÁVEL, EFICAZ, COM LÂMINAS TRAPEZOIDAIS SUBSTITUÍVEIS

Profissional

X-ATO para pladur



- Lâmina trapezoidal afiada substituível com superfície acetinada;
- Ideal para cortar gesso cartonado;
- Ideal para cortar alcatifas e abrir embalagens;
- Apoio do polegar para a condução segura da faca;
- Cabo de polímero prático com cavidades ergonómicas para os dedos e orifício para correia integrado;
- O bloqueio button lock mantém a lâmina na posição aberta;
- Cortador de fita como ajuda;
- Substituição rápida da lâmina sem usar ferramentas;
- Fácil de guardar no bolso das calças devido ao tamanho compacto;
- Fácil de guardar com clipe para cinto.

Fornecido com 5 lâminas de substituição + bolsa

Ref. ^a	Tamanho		Preço
600.300A	61 / 171 mm	1	35,00

4K5 UKR

X-ATO MULTIFUNCIONAL EXTREMAMENTE COMPACTO COMO AJUDA VERSÁTIL NO TRABALHO E NO QUOTIDIANO

Profissional



- Corte forte mesmo de materiais resistentes;
- Elevada segurança no trabalho e utilização confortável;
- Substituição rápida da lâmina sem usar ferramentas;
- Manutenção ideal das lâminas de substituição no carregador de lâminas integrado;
- Cortador de fita como ajuda;
- Dois posições de bloqueio conforme o requisito;
- Construção ergonómica e apoio do polegar antideslize;
- Caixa robusta revestida com borracha;
- Orifício prático para correia integrado.

Fornecido com 5 lâminas de substituição

Ref. ^a	Tamanho		Preço
600.308A	175 mm	1	23,00

4K5 CR 9

X-ATO COMPACTO COM LÂMINAS DE QUEBRAR INOXIDÁVEIS REVESTIDAS COM CARBONO

Lâminas inoxidáveis



- Lâminas de quebrar extremamente afiadas inoxidáveis e com revestimento de carbono;
- Corte preciso também em partes de difícil acesso;
- Manuseamento ideal devido à construção compacta;
- Bloqueio automático confortável da lâmina;
- Construção ergonómica e apoio do polegar antideslize;
- Substituição rápida da lâmina sem usar ferramentas;
- Ajuste fácil do comprimento da lâmina;
- Escala de régua prática adicional e chave de parafusos.

Fornecido com 5 lâminas de substituição

Ref. ^a	Tamanho		Preço
600.304A	147 mm	1	9,00

FERRAMENTAS DE CORTE



4K5 CR 18

X-ATO SÓLIDO COM LÂMINAS DE QUEBRAR INOXIDÁVEIS REVESTIDAS COM CARBONO

Lâminas inoxidáveis



Fornecido com 5 lâminas de substituição

- Lâminas de quebrar extremamente afiadas inoxidáveis e com revestimento de carbono;
- Bloqueio automático confortável da lâmina;
- A guia de metal robusta da lâmina permite grandes pressões;
- Construção ergonômica e apoio do polegar antideslize;
- Substituição rápida da lâmina sem usar ferramentas;
- Ajuste fácil do comprimento da lâmina;
- Orifício prático para correia integrado.

Ref. ^a	Tamanho		Preço
600.305A	157 mm	1	11,00

4K5 CRX 18

X-ATO EFICAZ COM LÂMINAS DE QUEBRAR INOXIDÁVEIS REVESTIDAS COM CARBONO E RODA DE BLOQUEIO ADICIONAL

Lâminas inoxidáveis



Fornecido com 5 lâminas de substituição

- Lâminas de quebrar extremamente afiadas inoxidáveis e com carbono;
- Elevada segurança e exatidão devido à roda de bloqueio adicional;
- Bloqueio automático confortável da lâmina;
- A guia de metal robusta da lâmina permite grandes pressões;
- Construção ergonômica e apoio do polegar antideslize;
- Substituição rápida da lâmina sem usar ferramentas;
- Ajuste fácil do comprimento da lâmina;

Ref. ^a	Tamanho		Preço
600.306A	182 mm	1	14,00

4K5 CRX 25

X-ATO FORTE COM LÂMINAS DE QUEBRAR INOXIDÁVEIS REVESTIDAS COM CARBONO E RODA DE BLOQUEIO ADICIONAL

Lâminas inoxidáveis



Fornecido com 5 lâminas de substituição

- Lâminas de quebrar extremamente afiadas inoxidáveis e com revestimento de carbono;
- Elevada segurança e exatidão devido à roda de bloqueio adicional;
- Bloqueio automático confortável da lâmina;
- A guia de metal robusta da lâmina permite grandes pressões;
- Caixa longa adequada para um corte forte com ambas as mãos;
- Construção ergonômica e apoio do polegar antideslize;
- Substituição rápida da lâmina sem usar ferramentas;
- Ajuste fácil do comprimento da lâmina;

Ref. ^a	Tamanho		Preço
600.307A	208 mm	1	17,00

LÂMINAS DE SUBSTITUIÇÃO

LÂMINA	Ref. ^a	Tamanho	X-ATOS		Preço
4K5 CB 9B	600.304.1	9 mm	CR 9	10	5,80
4K5 CB 18B	600.305.1	18 mm	CR 18 CRX 18	10	7,70
4K5 CB 25B	600.307.1	25 mm	CRX 25	10	12,00
4K5 TI 10	600.300.1	TRAPÉZIO	TK 300 UKR	10	5,90

FERRAMENTAS DE CORTE

4K5

BETTER EQUIPMENT

4K5 MT 400
FERRAMENTA MULTIFUNÇÃO DOBRÁVEL COMO AJUDA VERSÁTIL NO TRABALHO E NO QUOTIDIANO

- Muitas funções úteis reunidas num corpo de alicate;
- Ajuda prática no trabalho e no quotidiano;
- Pode ser usado como tesoura, alicate, cortador de arame, Phillips e chave de fendas, serra, lima de duas faces, abridor de garrafas e muito mais;
- Todas as ferramentas são feitas de aço inoxidável robusto com revestimento preto;
- Cada ferramenta é bloqueada com segurança na posição aberta;
- Utilização confortável com os cabos práticos de polímero;
- Fácil de guardar no cinto com a bolsa de nylon;
- O modelo dobrável compacto cabe em qualquer bolso.

Ref. ^a	Tamanho		Preço
600.400A	Grande	1	45,00

4K5 TS 500
TESOURA ROBUSTA E EXATA COM LÂMINAS DE AÇO INOXIDÁVEL REVESTIDAS COM TITÂNIO DE ALTA QUALIDADE

- Agudeza longa devido às lâminas de aço inoxidável com revestimento de titânio;
- Corte forte mesmo de materiais resistentes;
- Cabos de polímero com boa transmissão de força e elevado conforto no corte;
- Escala de régua prática adicional e chave de parafusos;
- Tanto para destros como para canhotos.

Ref. ^a	Tamanho		Preço
600.500A	25 cm	1	20,00

4K5 TS 501
TESOURA ROBUSTA E EXATA COM LÂMINAS DE AÇO INOXIDÁVEL REVESTIDAS COM TITÂNIO DE ALTA QUALIDADE E FORMA ANGULAR

- Agudeza longa devido às lâminas de aço inoxidável com revestimento de titânio;
- Corte forte mesmo de materiais resistentes;
- Cabos de polímero com boa transmissão de força e elevado conforto no corte;
- Forma angular ideal para cortes retos longos;
- Escala de régua prática adicional e chave de parafusos;
- Tanto para destros como para canhotos.

Ref. ^a	Tamanho		Preço
600.501A	25 cm	1	23,00

ACESSÓRIOS DE ILUMINAÇÃO



4K5 RA 500

LANTERNA DE TRABALHO COM CABEÇA DE ILUMINAÇÃO INCLINÁVEL



Profissional

500 lúmen

Carregamento USB-C

Fornecido com cabo USB-C

- Luminosidade eficiente de 500 lúmen;
- Quatro níveis de iluminação diferentes conforme o requisito (High/Boost/Medium/Low);
- Cabeça de iluminação com inclinação de 90° para a adaptação ao local de utilização;
- Magnético para a instalação em superfícies metálicas;
- Transporte prático devido ao clipe de bolso;
- Recarregável através de cabo USB-C;
- Bateria de íões de lítio integrada.

Ref. ^a	Tamanho		Preço
602.200A	15 cm	1	63,00

4K5 FL 800

CANDEIRO DE TRABALHO DOBRÁVEL 180° GIRATÓRIO E CABEÇA DE LUZ GIRATÓRIA DE 360°



800 lúmen

Profissional

Carregamento USB-C

Fornecido com cabo USB-C

- Intensidade de iluminação elevada de 800 lúmen;
- Quatro níveis de iluminação diferentes conforme o requisito (High/Boost/Medium/Low);
- Muito flexível devido ao giro de 180° e à cabeça de luz giratória de 360°;
- A indicação LED bem visível informa sobre a capacidade da bateria;
- Magnético para a instalação em superfícies metálicas;
- Transporte prático devido ao clipe de bolso;
- Recarregável através de cabo USB-C;
- Bateria removível de íões de lítio.

Ref. ^a	Tamanho		Preço
602.201A	18 cm	1	98,00

4K5 PL 700

LANTERNA DE TRABALHO COM FOCAGEM REGULÁVEL



700 lúmen

Profissional

Carregamento micro USB

Fornecido com Cabo micro USB, Bateria de íões de lítio, Correia de pulso, Bolsa.

- Intensidade de iluminação elevada de 700 lúmen;
- Quatro níveis de iluminação diferentes conforme o requisito (Low/Medium/High/Strobe);
- Ajuste fácil do cone luminoso conforme cada situação;
- Caixa de alumínio anodizada e protegida contra respingos;
- Transporte simples com bolsa para cinto ou alça..

Ref. ^a	Tamanho		Preço
602.305A	11 cm	1	95,00

4K5 PL 1000

LANTERNA DE TRABALHO COM LUMINOSIDADE EXTREMAMENTE FORTE E FOCAGEM REGULÁVEL



Profissional

1000 lúmen

Carregamento micro USB

Fornecido com Carregador, Cabo micro USB, Unidade de alimentação, Gaiola de bateria, Manga de carga, Adaptador USB para automóvel, Bateria de íões de lítio, Correia de pulso, Bolsa.

- Luminosidade extremamente forte de 1000 lúmen;
- Quatro níveis de iluminação diferentes conforme o requisito (Low/Medium/High/Strobe);
- Ajuste fácil do cone luminoso conforme cada situação;
- Caixa de alumínio anodizada e protegida contra respingos;
- Transporte simples com bolsa para cinto ou alça.

Ref. ^a	Tamanho		Preço
602.307A	14 cm	1	160,00

ACESSÓRIOS DE ILUMINAÇÃO



4K5 WP 400

Profissional



400 lúmen

Carregamento USB-C

LANTERNA DE CABEÇA LED POTENTE COM FUNÇÃO AUTOMÁTICA DE REGULAÇÃO DA INTENSIDADE DA LUZ E ELEVADO CONFORTO DE USO - MÃOS LIVRES DURANTE O TRABALHO

- Luminosidade forte de 400 lúmen;
- Três níveis de iluminação diferentes conforme o requisito (High/Medium/Low);
- Modo adicional Red e Red Blink;
- Rotação gradual da cabeça de iluminação possível até 90°;
- Regulação automática da intensidade da luz para a observação ideal de objetos;
- Posição segura com a borracha, sem deslizar nem escorregar;
- Elevado conforto de uso: fita elástica, adequada para qualquer tamanho de cabeça;
- Bateria recarregável de íões de lítio através de cabo USB-C.

Fornecido com fita elástica, 2 Grampos de fixação para capacete de obras, Cabo USB-C, Bateria de íões de lítio

Ref. ^a	Tamanho		Preço
602.104A	4x6 cm	1	60,00

4K5 WP 550

Profissional



550 lúmen

Carregamento USB-C

LANTERNA DE CABEÇA LED EFICIENTE COM ELEVADA LUMINOSIDADE, MODO DE SENSOR LIGADO PARA LIGAR E DESLIGAR DEPRESSA, BEM COMO ELEVADO CONFORTO DE USO

- Luminosidade considerável de 550 lúmen;
- Três níveis de iluminação diferentes conforme o requisito (High/Medium/Low);
- Modo adicional Red e Red Blink;
- Ativação e desativação prática e rápida com um movimento da mão à frente do sensor;
- Rotação gradual da cabeça de iluminação possível até 90°;
- Posição segura com a borracha, sem deslizar nem escorregar;
- Elevado conforto de uso: fita elástica, adequada para qualquer tamanho de cabeça;
- Bateria recarregável de íões de lítio através de cabo USB-C.

Fornecido com fita elástica, 2 Grampos de fixação para capacete de obras, Cabo USB-C, Bateria de íões de lítio

Ref. ^a	Tamanho		Preço
602.106A	4x6 cm	1	65,00

4K5 HD 1500

Profissional



1500 lúmen

2000 lúmen



4K5 HD 2000

PROJETOR LED PARA OBRAS, COM PROTEÇÃO CONTRA RESPINGOS, REFLETOR E HOLOFOTE DE REGULAÇÃO PROGRESSIVA E POSSIBILIDADES DE FIXAÇÃO EXTENSAS

- Iluminação eficiente através do holofote de regulação progressiva com 1500 lúmen e do refletor com 500 lúmen;
- Difusor para regular uma luz de cobertura geral;
- Possibilidades de fixação extensas com gancho, íman, suporte e ligação para tripé;
- Posicionamento perfeito através de 360° de rotação do suporte multifuncional e 180° de inclinação;
- Elevada segurança com Object Sensor System para a deteção de obstáculos;
- Poupança eficaz de eletricidade com Human Body Sensor;
- Função SOS para a utilização do holofote em situações de emergência;
- Deteção fácil no escuro devido ao refletor fluorescente;
- Indicação bem visível do estado de carga da bateria e do estado HBS;
- Bateria de íões de lítio integrada.

Fornecido com Difusor, Unidade de alimentação, Cabo USB-C

Ref. ^a	Tamanho		Preço
602.401A (HD1500)	7x13 cm	1	210,00
602.402A (HD2000)	7x13 cm	1	250,00

4K5 HD 6000 C

Profissional



6000 lúmen

PROJETOR LED PARA OBRAS, ROBUSTO, COM LUMINOSIDADE E POWERBANK INTEGRADO, ADEQUADO PARA A OPERAÇÃO COM REDE

- A luminosidade muito grande de 6000 lúmen garante uma visibilidade excelente;
- Cinco níveis de iluminação com barra de indicação de fácil leitura;
- Ajuste da claridade e desconexão também com a app Light Control;
- Posicionamento fácil através do suporte com inclinação de 180°;
- Possibilidade de utilização como powerbank para carregar dispositivos móveis;
- Adequado tanto para a operação com bateria como com rede;
- Deteção fácil no escuro devido ao refletor fluorescente;
- IP 67: o aparelho é à prova de pó e pode ser temporariamente submerso;
- Indicação a cores e percentual bem visível do estado de carga da bateria;
- Bateria de íões de lítio integrada.

Ref. ^a	Tamanho		Preço
602.404A	21x21 cm	1	320,00

**ABRAÇADEIRAS SEM FIM
DIN 3017
ZINCADO W1 - INOX W2 - INOX W4**



- BANDAS DE 9 E 12 mm
- W1 - BANDA E PARAFUSO ZINCADOS
- W2 - BANDA INOX 304 E PARAFUSO ZINCADO
- W4 - BANDA E PARAFUSO INOX 304 - O PARAFUSO INOX É ZINCADO PARA REDUZIR O ATRITO

DIMENSÕES		BANDA DE 12 mm				BANDA DE 9 mm			
DIÂMETRO APERTO [mm]	MEDIDA ["]		PREÇO				PREÇO		
			INOX W4	INOX W2	ZINCADO W1		INOX W4	INOX W2	ZINCADO W1
8-12						100	27,41	14,23	12,54
10-16	3/16"					100	27,41	14,23	12,54
12-22	3/8"					100	27,95	15,21	13,45
16-25	1/2"	100	35,66	20,65	15,83	100	28,48	15,71	13,91
20-32	3/4"	100	40,03	22,83	17,68	100	31,64	17,67	14,82
25-40	1"	100	42,49	24,42	18,72	100	33,23	19,15	15,76
30-45	1 1/4"	100	44,98	25,14	20,02	50	35,07	19,88	17,02
32-50	1 1/2"	50	46,35	25,65	20,47	50	35,61	20,38	17,25
40-60	1 3/4"	50	48,25	27,78	22,96	50	40,32	25,14	20,64
50-70	2"	50	52,76	30,10	25,30	50	43,86	26,82	22,51
60-80	2 1/2"	50	57,87	31,88	27,15	50	46,80	27,96	23,82
70-90	3"	25	60,54	34,68	30,29	50	49,82	30,74	26,36
80-100		25	60,64	38,85	34,50	50	52,88	34,10	30,94
90-110	4"	25	66,79	40,00	36,27	50	54,80	35,86	32,25
100-120		25	74,88	45,59	40,66	50	57,82	37,08	34,31
110-130	5"	25	83,51	54,00	43,34	50	60,77	39,81	36,60
120-140		25	85,63	55,79	52,49	50	63,44	41,21	40,00
130-150	6"	25	89,11	60,40	56,98				
140-160		25	94,53	64,44	61,93				
150-170		25	98,03	66,28	64,31				
160-180		25	102,19	68,69	67,32				
170-190		25	107,02	73,34	71,96				
180-200		25	113,82	81,31	74,49				
190-210		25	133,15	102,41	88,55				
200-220		25	141,10	107,59	77,92				
210-230		25	144,71	109,59	79,13				
220-240		25	149,05	118,26	80,38				
230-250		25	154,10	120,92	82,79				
240-260		25	156,99	124,25	84,61				

ABRAÇADEIRAS COM BANDA PERFURADA EM AÇO INOX E PARAFUSO ZINCADO

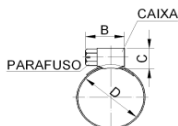

BANDA DE 8 mm

BANDA DE 13 mm

BINÁRIO MÁXIMO DE APERTO: 3 Nm • B=17,4 • C=8,5

BINÁRIO MÁXIMO DE APERTO: 5 Nm • B=28,2 • C=11,7

DIÂMETRO DE APERTO D [mm]	ESPESSURA DA BANDA [mm]		PREÇO	DIÂMETRO DE APERTO D [mm]	ESPESSURA DA BANDA [mm]		PREÇO
8-12	0,55	200	29,00				
10-16	0,55	200	31,00				
12-22	0,55	200	33,00				
14-24	0,55	200	33,00				
16-28	0,55	200	33,00	14-22	0,58	100	42,00
20-32	0,55	200	36,00	16-28	0,58	100	42,00
23-36	0,55	200	36,00	23-36	0,58	100	46,00
25-45	0,55	100	38,00	25-45	0,58	100	46,00
30-45	0,55	100	40,00	30-45	0,58	100	51,00
32-52	0,55	100	42,00	32-52	0,58	100	55,00
40-60	0,55	50	42,00	40-60	0,58	100	58,00
47-67	0,55	50	43,00	47-67	0,58	100	62,00
50-70	0,55	50	43,00	50-70	0,58	100	63,00
60-82	0,55	50	43,00	60-82	0,58	50	63,00
70-90	0,55	50	44,00	70-90	0,58	50	65,00
77-97	0,55	50	46,00	77-97	0,58	50	69,00
80-100	0,55	50	47,00	80-100	0,58	50	69,00
90-112	0,55	25	51,00	90-112	0,58	50	72,00
100-120	0,55	25	53,00				
107-127	0,55	25	56,00	107-127	0,68	25	76,00
122-142	0,55	25	64,00	120-142	0,68	25	108,00
				130-150	0,68	25	119,00
137-157	0,55	25	70,00	137-157	0,68	25	123,00
				140-160	0,68	25	129,00
152-172	0,55	25	80,00	150-172	0,68	20	140,00
				160-180	0,68	20	151,00
167-187	0,55	25	92,00	167-187	0,68	20	163,00
				170-190	0,68	20	163,00
182-202	0,55	25	101,00	180-202	0,68	20	173,00
197-217	0,55	25	114,00	197-217	0,68	20	190,00
212-232	0,55	25	126,00	212-232	0,68	20	209,00
227-247	0,55	25	143,00	227-247	0,68	20	221,00
242-262	0,55	25	159,00	242-262	0,68	20	239,00

ABRAÇADEIRAS COM BANDA PERFURADA E PARAFUSO EM AÇO INOX

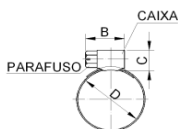

BANDA DE 9 mm

BANDA DE 13 mm

BINÁRIO MÁXIMO DE APERTO: 5 Nm • B=21,3 • C=9,8

BINÁRIO MÁXIMO DE APERTO: 6 Nm • B=26,2 • C=11,3

DIÂMETRO DE APERTO D [mm]	ESPESSURA DA BANDA [mm]		PREÇO	DIÂMETRO DE APERTO D [mm]	ESPESSURA DA BANDA [mm]		PREÇO
10-16	0,54	200	59,00				
12-22	0,54	200	62,00				
16-28	0,54	200	64,00	14-22	0,54	100	71,00
23-36	0,54	200	67,00	16-28	0,54	100	74,00
25-45	0,54	100	70,00	23-36	0,54	100	79,00
30-45	0,54	100	71,00	25-45	0,54	100	84,00
32-52	0,54	100	73,00				
40-67	0,54	50	77,00	32-52	0,54	100	89,00
50-70	0,54	50	81,00	40-62	0,54	50	94,00
60-82	0,54	50	84,00				
70-97	0,54	50	89,00	60-82	0,54	50	106,00
80-100	0,54	50	94,00	70-97	0,54	50	108,00
90-112	0,54	25	99,00				
100-120	0,54	25	103,00	90-112	0,54	25	122,00
107-130	0,54	25	108,00	100-120	0,54	25	126,00
120-140	0,54	25	113,00	107-130	0,54	25	131,00
130-157	0,54	25	119,00	120-142	0,54	25	136,00
152-172	0,54	25	121,00	130-157	0,54	25	147,00
167-187	0,54	25	126,00	150-172	0,54	20	169,00
				160-187	0,54	20	181,00
				170-190	0,54	20	192,00
182-202	0,54	25	129,00	180-202	0,54	20	203,00
197-217	0,54	25	134,00	197-217	0,54	20	203,00
212-232	0,54	25	136,00	212-232	0,54	20	203,00
227-247	0,54	25	144,00	227-249	0,54	20	203,00
242-262	0,54	25	149,00	242-264	0,54	20	204,00

ABRAÇADEIRAS SUPER



- W1 - BANDA E PARAFUSO ZINCADOS
- W2 - BANDA INOX AISI 201 E PARAFUSO ZINCADO
- W4 - BANDA E PARAFUSO INOX-A2 - AISI 304
- W5 - BANDA E PARAFUSO INOX A4 - AISI 316

PARAFAST

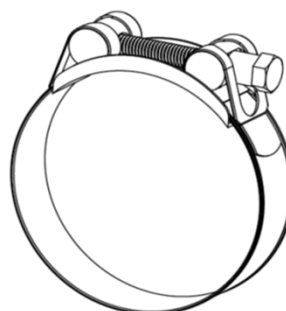
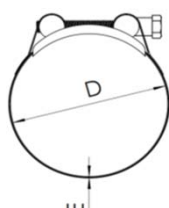

DIÂMETRO APERTO D [mm]	BANDA A x E [mm]			INOX A4	INOX A2	BANDA: INOX AISI 201 PARAFUSO: ZINCADO	ZINCADO	
	W1	W2,W4,W5		W5	W4	W2	W1	
				PREÇO	PREÇO	PREÇO	PREÇO	
17-19	18x0,6	18x0,6	50	151,10	110,51	46,17	36,67	
20-22				154,57	112,68	46,62	37,12	
23-25				157,62	114,01	47,08	37,58	
26-28				161,10	115,33	47,97	38,04	
29-31	20x0,8	20x0,6		180,93	131,70	52,25	44,42	
32-35				184,81	134,29	53,98	45,34	
36-39				189,15	137,38	55,44	46,27	
40-43				193,19	139,64	56,74	47,09	
44-47	22x1,2	22x0,8		226,87	164,26	67,10	59,65	
48-51				232,68	167,91	69,46	60,96	
52-55				242,42	175,49	74,88	66,24	
56-59				248,08	179,43	77,09	67,56	
60-63	24x1,5	24x0,8		25	254,17	183,36	78,84	68,48
64-67					323,79	240,89	93,21	90,10
68-73					333,29	248,23	96,66	92,85
74-79					341,35	255,42	99,54	94,61
80-85			349,12		261,90	102,13	97,38	
86-91			357,35		269,26	105,17	99,03	
92-97			365,12		275,73	107,76	102,15	
98-103			381,77		288,93	114,48	105,13	
104-112	26x1,7	26x1,0	10	391,34	298,07	118,01	109,34	
113-121				401,26	307,99	122,31	113,67	
122-130				410,76	317,05	126,19	117,13	
131-139				536,61	439,02	186,41	182,09	
140-148				550,85	447,65	187,94	186,41	
149-161				570,28	463,62	197,20	195,90	
162-174				604,39	483,05	204,97	202,38	
175-187				622,74	500,97	221,59	213,82	
188-200	201-213		636,99	513,93	233,25	224,62		
201-213			657,94	531,85	243,84	236,07		

**ABRAÇADEIRAS REFORÇADAS
COM PORCA M8+M10 - SIMPLES**
ZINCADAS (W1) - INOX 304 (W4) - INOX 316 (W5)



- ZINCADAS: FABRICADAS EM CHAPA 20x2 mm ATÉ Ø180 E 20x2,5 ACIMA DESTA MEDIDA
- INOX 304 E 316: FABRICADAS EM CHAPA 20x2 mm ATÉ Ø100 E 20x2,5 ACIMA DESTA MEDIDA
- PORCA M8+M10 E PARAFUSOS LATERAIS M6

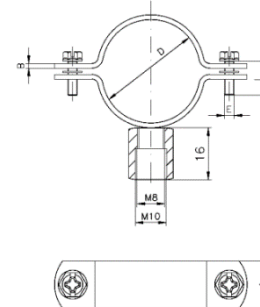

DESCIDA DE PREÇO

SIMPLES

MEDIDA D [Ømm]	MEDIDA D [Ø"]	DIÂMETRO APERTO [mm]		INOX A4 (AISI 316) W5	INOX A2 (AISI 304) W4	ZINCADO W1
Ø 18	3/8"	15-19	200	157,99	103,55	36,16
Ø 22	1/2"	20-25	200	167,81	110,28	39,27
Ø 28	3/4"	26-30	200	181,13	115,40	41,02
Ø 35	1"	32-36	200	190,18	119,90	42,77
Ø 40	1 1/4"	38-43	100	201,57	121,89	46,66
Ø 48	1 1/2"	47-51	100	215,64	147,43	50,54
Ø 54		53-58	100	229,93	153,12	55,02
Ø 60	2"	60-64	100	243,22	162,22	56,57
Ø 70		68-72	100	252,70	172,95	59,29
Ø 75	2 1/2"	75-80	100	265,04	186,24	60,65
Ø 83		80-86	50	277,94	222,09	62,41
Ø 90	3"	87-92	50	290,69	249,39	63,95
Ø 100	3 1/2"	96-101	50	316,34	267,29	65,51
Ø 110	4"	105-111	50	330,99	294,31	67,07
Ø 115		109-116	50	339,30	304,80	68,04
Ø 125	5"	120-126	50	352,41	307,42	70,37
Ø 140		136-142	25	374,59	327,85	72,90
Ø 150		145-150	25	409,11	351,18	78,53
Ø 160	6"	157-161	25	423,00	373,23	84,95
Ø 180		179-184	25	453,67	398,89	88,94
Ø 200		199-205	25	484,25	450,30	92,93
Ø 220	8"	215-220	25			120,56
Ø 250		246-254	25			146,43
Ø 300		296-304	25			166,32
Ø 315		314-319	10			173,38
Ø 355		354-359	10			184,46
Ø 400		399-404	10			208,61
Ø 450		449-454	10			229,40
Ø 500		499-504	10			291,94

**ABRAÇADEIRAS REFORÇADAS
COM PORCA M8+M10 - ISOFÔNICAS
ZINCADAS (W1) - INOX A2 (W4) - INOX A4 (W5)**



- ZINCADAS: FABRICADAS EM CHAPA 20x2 mm ATÉ Ø180 E 20x2,5 ACIMA DESTA MEDIDA
- INOX 304 E 316: FABRICADAS EM CHAPA 20x2 mm ATÉ Ø100 E 20x2,5 ACIMA DESTA MEDIDA
- PORCA M8+M10 E PARAFUSOS LATERAIS M6
- BORRACHA EPDM
- DIN 4109

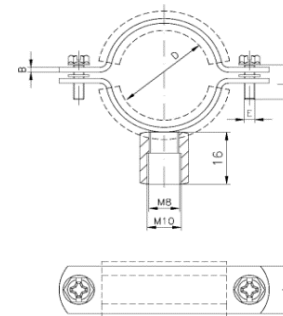

DESCIDA
DE
PREÇO

ISO FÔNICAS - DIN 4109

MEDIDA D [Ømm]	MEDIDA D [Ø"]	DIÂMETRO APERTO [mm]		INOX A4 (AISI 316) W5	INOX A2 (AISI 304) W4	ZINCADO W1
Ø 18	3/8"	15-19	50	192,80	121,83	38,75
Ø 22	1/2"	20-25	50	195,93	129,73	41,43
Ø 28	3/4"	26-30	50	206,25	135,76	43,82
Ø 35	1"	32-36	50	215,99	141,06	47,39
Ø 40	1 1/4"	38-43	25	227,12	143,36	51,87
Ø 48	1 1/2"	47-51	25	244,66	173,44	56,94
Ø 54		53-58	25	259,66	180,14	60,52
Ø 60	2"	60-64	25	281,30	190,86	64,67
Ø 70		68-72	25	299,49	203,47	68,86
Ø 75	2 1/2"	75-80	25	302,37	219,10	72,14
Ø 83		80-86	25	319,90	246,76	76,30
Ø 90	3"	87-92	25	335,11	277,11	79,30
Ø 100	3 1/2"	96-101	25	363,57	297,00	94,79
Ø 110	4"	105-111	25	380,91	327,01	103,13
Ø 115		109-116	25	387,15	338,68	109,39
Ø 125	5"	120-126	25	401,19	356,64	113,86
Ø 140		136-142	25	429,86	373,80	141,71
Ø 150		145-150	25	469,62	395,62	143,47
Ø 160	6"	157-161	25	486,78	407,86	150,46
Ø 180		179-184	25	523,81	438,64	159,21
Ø 200		199-205	25	564,16	483,45	166,21
Ø 220	8"	215-220	25			243,64
Ø 250		246-254	25			305,79
Ø 300		296-304	25			328,99
Ø 315		314-319	10			353,36
Ø 355		354-359	10			426,45
Ø 400		399-404	10			436,80
Ø 450		449-454	10			482,65
Ø 500		499-504	10			521,87

HASTES ROSCADAS COM DUAS ROSCAS
(ROSCA DE MADEIRA + ROSCA MÉTRICA)
HEXAGONAL AO MEIO + TORX



- Aço zincado
- Aço INOX A2



MEDIDA D [Ømm]	INOX A2		ZINCADO	
		PREÇO		PREÇO
M8 x 50	100	54,60		
M8 x 80	100	72,07	100	22,30
M8 x 90			100	22,81
M8 x 100			100	23,47
M8 x 110	100	98,28	100	22,30
M8 x 120			100	29,33
M8 x 130			100	31,99
M8 x 140			100	34,10
M10 x 80			100	27,29
M10 x 90			100	30,00
M10 x 100			100	33,97
M10 x 110			50	37,00
M10 x 120			50	41,06
M10 x 130			25	45,00
M10 x 140			25	51,00
M10 x 150			25	57,00

**ABRAÇADEIRAS REFORÇADAS
COM PORCA M8 - ZINCADAS W1
SIMPLES E COM BORRACHA - ISOFÔNICAS**



- FABRICADAS EM CHAPA 20x2 mm ZINCADA
- PORCA M8 E PARAFUSOS LATERAIS M6 ZINCADOS



SIMPLES					COM BORRACHA - ISOFÔNICAS				
MEDIDA (D)				PREÇO	MEDIDA (D)				PREÇO
Ø	mm	"		W1	Ø	mm	"		W1
Ø 18	17-20	3/8"	50	44,75	Ø 18	17-20	3/8"	50	56,27
Ø 22	20-25	1/2"	50	49,03	Ø 22	20-25	1/2"	50	56,27
Ø 28	26-30	3/4"	50	51,45	Ø 28	26-30	3/4"	50	58,95
Ø 35	32-36	1"	25	54,66	Ø 35	32-36	1"	50	64,31
Ø 40	38-45	1 1/4"	25	56,80	Ø 40	38-45	1 1/4"	25	72,35
Ø 48	47-51	1 1/2"	25	60,29	Ø 48	47-51	1 1/2"	25	77,70
Ø 54	53-58		25	62,43	Ø 54	53-58		25	83,06
Ø 60	60-64	2"	25	64,58	Ø 60	60-64	2"	25	91,10
Ø 70	68-72		25		Ø 70	68-72		25	107,18
Ø 75	74-80	2 1/2"	25	70,20	Ø 75	74-80	2 1/2"	25	109,86
Ø 83	81-86		25		Ø 83	81-86		25	117,90
Ø 90	87-92	3"	25	74,76	Ø 90	87-92	3"	25	123,26
Ø 100	99-105		25	76,90	Ø 100	99-105		25	136,65
Ø 110	107-112	4"	25	79,04	Ø 110	107-112	4"	25	152,73
Ø 115	113-118		25	80,38	Ø 115	113-118		25	160,77
Ø 125	125-130	5"	25	83,60	Ø 125	125-130	5"	25	174,17
Ø 133	131-137		25		Ø 133	131-137		25	198,28
Ø 140	138-142	6"	25	87,08	Ø 140	138-142	6"	25	203,64
Ø 150	148-152		25	94,85	Ø 150	148-152		25	206,32
Ø 160	159-166		25	103,70	Ø 160	159-166		25	217,04
Ø 170	168-172		25		Ø 170	168-172		25	230,43
Ø 180	179-184		25	109,19	Ø 180	179-184		25	
Ø 200	200-205		25	114,68	Ø 200	200-205		25	241,15
Ø 220	215-220		25	252,67	Ø 220	215-220		25	380,49
Ø 225	223-228		25	266,34	Ø 225	223-228		25	427,64
Ø 250	249-254		25	303,85	Ø 250	249-254		25	480,97
Ø 280	279-284		25	390,40	Ø 280	279-284		25	508,56
Ø 300	299-304		25	410,23	Ø 300	299-304		25	518,48
Ø 315	314-319		25	459,26	Ø 315	314-319		25	557,87
Ø 350	354-359		25	498,65	Ø 350	354-359		25	676,03

**ABRAÇADEIRAS REFORÇADAS
COM PORCA M8 - INOX 316
SIMPLES E COM BORRACHA - ISOFÔNICAS**



- FABRICADAS EM CHAPA 20x2 mm INOX 316
- PORCA M8 E PARAFUSOS LATERAIS M6 INOX 316



SIMPLES					COM BORRACHA - ISOFÔNICAS				
MEDIDA (D)				PREÇO	MEDIDA (D)				PREÇO
Ø	mm	"		INOX 316	Ø	mm	"		INOX 316
	15-18	3/8	50	130,75	Ø 18	17-20	3/8"	50	
	18-25	1/2	50	140,21	Ø 22	20-25	1/2"	50	181,73
	25-32	3/4	50	149,68	Ø 28	26-30	3/4"	50	187,79
	33-40	1	25	157,55	Ø 35	32-36	1"	50	196,80
	37-44	1 1/4	25	168,57	Ø 40	38-45	1 1/4"	25	207,83
	46-53	1 1/2	25	179,61	Ø 48	47-51	1 1/2"	25	223,86
Ø 54	49-60		25	192,20	Ø 54	53-58		25	237,95
	57-70	2	25	211,11	Ø 60	60-64	2"	25	268,38
	68-72		25		Ø 70	68-72		25	281,52
	71-85	2 1/2	25	231,58	Ø 75	74-80	2 1/2"	25	288,76
	81-86		25		Ø 83	81-86		25	299,44
	86-100	3	25	241,03	Ø 90	87-92	3"	25	307,49
Ø 100	91-105		25	253,62	Ø 100	99-105		25	324,18
	100-112		25		Ø 110	107-112	4"	25	339,08
Ø 110	101-115		25	264,67	Ø 115	113-118		25	349,45
	106-120	4	25	277,28	Ø 125	125-130	5"	25	367,13
Ø 125	116-130		25	293,02	Ø 133	131-137		25	375,35
	128-142	5	25	302,45	Ø 140	138-142	6"	25	385,02
Ø 154	147-168		25	315,07	Ø 150	148-152		25	404,77
	156-170	6	25	326,11	Ø 160	159-166		25	420,47
	170-184		25		Ø 170	168-172		25	434,07
Ø 204	197-211		25	341,86	Ø 180	179-184		25	
					Ø 200	200-205		25	457,15
					Ø 220	215-220		25	

Edição: 1/2006

Data: Setembro 2006

Revisão: 0

Data:

Preço: €100

TABELA 13.5

ABRAÇADEIRAS EXTRA-REFORÇADAS "RM" COM PORCA M8 OU M10 AÇO INOX AISI 304



- FABRICADAS EM CHAPA 20x2,5 OU 30x2,5 mm INOX AISI 304
- PORCA M8 OU M10 E PARAFUSOS LATERAIS M6 INOX AISI 304



COM PORCA M8 - CHAPA 20x2,5				COM PORCA M10 - CHAPA 30x2,5			
MEDIDA (D)			PREÇO	MEDIDA (D)			PREÇO
mm	"		INOX 304	mm	"		INOX 304
15-18	3/8"	50	83,39	71-85	2 1/2"	50	177,54
18-25	1/2"	50	87,70	86-100	3"	50	188,61
25-32	3/4"	50	92,91	91-105	Ø 100	50	196,64
33-40	1"	25	98,21	101-115	Ø 110	50	207,92
37-44	1 1/4"	25	102,01	106-120	4"	25	213,35
46-53	1 1/2"	25	110,04	116-130	Ø 125	25	224,20
49-60	Ø 54	25	113,36	128-142	5"	25	238,74
57-70	2"	25	119,87	147-168	Ø 154	25	253,93
				156-170	6"	25	266,52
				197-211	Ø 204	25	310,36

ABRAÇADEIRAS FILTUBE EM AÇO INOXIDÁVEL

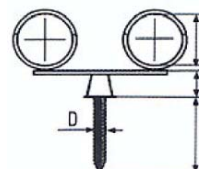
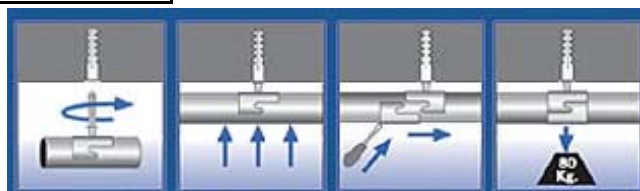
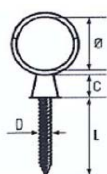

SIMPLES						DUPLAS					
DIÂMETRO Ø [mm]	D	L	C		INOX A2	DIÂMETRO Ø [mm]	D	L	C		INOX A2
12	3,9	25	7	150	48,00						
15	4,8	35	7	90	40,50	15	4,8	35	8	30	127,50
18	4,8	35	7	60	46,50	18	4,8	35	8	25	145,50
22	4,8	35	7	40	60,00	22	4,8	35	8	15	181,50
28	4,8	35	7	20	112,50						
35	6,3	45	9	10	192,00						
42	6,3	45	9	7	261,00						

ABRAÇADEIRAS GAZ



- ZINCADAS
- INOX AISI 304





DIÂMETRO APERTO [mm]		ZINCADO	INOX A2	DIÂMETRO APERTO [mm]		ZINCADO	INOX A2	DIÂMETRO APERTO [mm]		ZINCADO	INOX A2
7-9	100	13,50		15-17	100	17,00		23-25	100		
8-10	100	13,50	37,50	16-18	100	17,96		24-26	100		
9-11	100	13,50	37,50	17-19	100	18,72		25-27	100		
10-12	100	13,50	37,50	18-20	100	19,00		26-28	100		
11-13	100	13,50	39,00	19-21	100	19,35		27-29	100		
12-14	100	16,50	39,00	20-22	100	19,70		28-30	100		
13-15	100	16,50		21-23	100	20,00		29-31	100		
14-16	100	16,50		22-24	100	20,30					

ABRAÇADEIRAS COM ESPIGÃO SIMPLES E DUPLAS



• ZINCADAS

SIMPLES			DUPLA		
DIÂMETRO APERTO [mm]		ZINCADO	DIÂMETRO APERTO [mm]		ZINCADO
10-12	100	18,71	10-12	100	27,69
14-16	100	20,96	14-16	100	29,93
18-20	100	22,44	18-20	100	33,68
22-24	100	26,94	22-24	50	35,91
26-28	100	27,69	26-28	50	36,66

ABARCONES COMPLETOS MONTADOS



• ZINCADOS
• INOX 304
• INOX 316

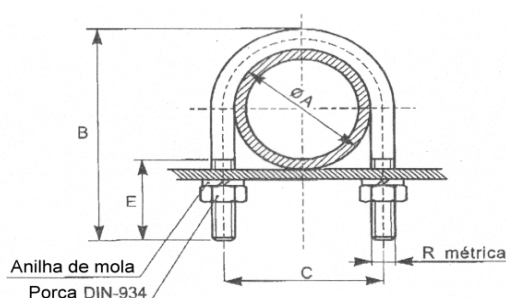

Quantidades por encomenda

MEDIDA		B	C	E	R	PERÍMETRO		ZINCADO	INOX 304	INOX 316
[", mm]	Ø A[mm]									
1/4"	14	47	20	35	M6	108	100	20,21	58,66	
3/8"	18	50	24	35	M6	114	100	20,21	58,66	
1/2"	22	53	28	35	M6	122	100	20,61	58,66	71,62
3/4"	28	59	34	35	M6	137	100	21,02	62,23	76,32
1"	34	65	40	35	M6	153	100	21,81	66,66	81,11
Ø 38	39	70	42	35	M6	166	100	22,62	71,12	
1 1/4"	43	74	49	35	M6	176	100	23,43	76,45	88,87
1 1/2"	49	85	57	40	M8	203	100	35,55	130,09	159,87
Ø 53	54	96	61	40	M8	227	50	37,17	131,56	
Ø 54	55	97	62	40	M8	230	50	37,98	131,56	
2"	61	99	70	40	M8	237	50	38,79	140,44	
Ø 65	66	98	73	40	M8	238	50	39,60	147,54	
Ø 70	71	102	78	40	M8	249	50	40,00	154,00	
2 1/2"	77	113	83	40	M8	275	50	40,41	161,77	204,26
Ø 84	85	117	94	40	M8	287	50	42,83	172,45	
3"	90	126	98	40	M8	308	50	45,26	184,89	223,62
Ø 104	105	149	114	40	M10	364	25	80,81	273,77	
4"	115	155	125	40	M10	381	25	84,03	275,55	476,31
Ø 129	130	170	140	40	M10	420	25	88,89	293,33	
5"	144	184	154	40	M10	456	25	95,36	314,66	526,43
Ø 154	155	194	164	40	M10	482	25	109,08	332,43	
6"	170	210	180	40	M10	523	25	116,36	364,44	592,08
Ø 204	206	244	214	40	M10	611	25	126,00	401,76	
8"	221	259	230	40	M10	650	25	136,00	440,00	717,55
Ø 254	256	294	264	40	M10	740	25	146,00	484,43	
10"	275	313	284	40	M10	789	25	156,00	506,00	858,41
Ø 304	306	344	314	50	M10	868	25	166,00	533,31	
Ø 350	354	407	364	50	M10	1016	25	180,00	550,00	

ABRAÇADEIRAS M6 SIMPLES E DUPLAS COM E SEM PARAFUSO



• ZINCADAS



SIMPLES					DUPLA				
DIÂMETRO APERTO [mm]	SEM PARAFUSO		COM PARAFUSO		DIÂMETRO APERTO [mm]	SEM PARAFUSO		COM PARAFUSO	
		ZINCADO		ZINCADO			ZINCADO		ZINCADO
Ø 8	100	8,40	100	11,55	Ø 8				
Ø 10	100	8,55	100	11,55	Ø 10	50	14,40	50	18,00
Ø 12	100	8,70	100	11,70	Ø 12				
Ø 14	100	9,00	100	12,00	Ø 14	50	15,30	50	19,20
Ø 15	100	9,15	100	12,15	Ø 15				
Ø 16	100	9,45	100	12,45	Ø 16				
Ø 18	100	9,60	100	12,60	Ø 18	50	16,05	50	20,10
Ø 20	100	9,75	100	13,05	Ø 20				
Ø 22	100	9,90	100	13,50	Ø 22	50	18,45	50	22,80
Ø 25	100	10,20	100	13,80	Ø 25				
Ø 26	100	10,80	100	14,10	Ø 26	50	26,10	50	30,00
Ø 28	100	11,25	100	14,40	Ø 28				
Ø 30	50	11,40	50	16,05	Ø 30				
Ø 32	50	12,75	50	16,20	Ø 32				
Ø 35	50	15,15	50	18,45	Ø 35				
Ø 37	50	16,05	50	19,80	Ø 37				
Ø 42	50	16,80	50	20,10	Ø 42				
Ø 47	50	17,55	50	21,60	Ø 47				
Ø 50	50	19,20	50	23,70	Ø 50				
Ø 54	50	23,40	50	28,65	Ø 54				
Ø 60	50	27,15	50	30,75	Ø 60				
Ø 63	50	27,75	50	32,10	Ø 63				

ABRAÇADEIRAS M6 ISOFÔNICAS SIMPLES E DUPLAS



• ZINCADAS



SIMPLES			DUPLA		
DIÂMETRO APERTO [mm]		ZINCADO	DIÂMETRO APERTO [mm]		ZINCADO
Ø 12	100	14,25	10-12	50	24,00
Ø 14	100	14,70	14-16	50	25,50
Ø 16	100	15,45			
Ø 18	100	16,50	18-20	50	28,50
Ø 20	100	18,00			
Ø 22	100	18,30	22-24	50	33,00
Ø 26	100	19,65	26-28	50	39,00
Ø 28	100	20,70			
Ø 32	50	23,40			
Ø 35	50	26,40			
Ø 42	50	28,35			
Ø 48	50	33,45			
Ø 54	50	36,60			
Ø 60	50	37,20			

ACESSÓRIOS PARA ABRAÇADEIRAS

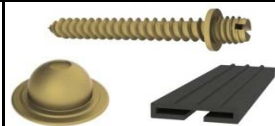

PARAFUSO PARA ABRAÇADEIRA M6			SEPARADOR DE ABRAÇADEIRA				PERFIL DE BORRACHA	
MEDIDA		ZINCADO	ALTURA	DIÂMETRO		ZINCADO	LARGURA	PREÇO/100m
M6x30	100	2,70	9	Ø 27	100	5,10	28 mm	112,50
M6x40	100	3,15	14	Ø 32	100	8,25		
M6x50	100	3,90	19	Ø 38	100	13,50		
			24	Ø 40	100	16,50		
			30	Ø 42	100	18,75		

Edição: 1/2006

Revisão: 0

Preço: €100

TABELA 13.8

Data: Setembro 2006

Data:

**ABRAÇADEIRAS PLASTIFICADAS
GÁSMICA - PRETO - SIMPLES E DUPLA
GÁSFIX - AMARELO - SIMPLES**



• PLASTIFICADA PRETO

• PLASTIFICADA AMARELO



GASMICA - PLASTIFICADA PRETO							GASFIX - PLASTIFICADA AMARELO				
DIMENSÕES			SIMPLES		DUPLA		DIMENSÕES			SIMPLES	
Ø [mm]	APERTO	MEDIDA"		PREÇO		PREÇO	Ø [mm]	APERTO	MEDIDA"		PREÇO
Ø 12	11-12	1/4	100	21,75	50	30,75	Ø 12	11-12	1/4	100	45,00
Ø 14	13-14		100	23,25			Ø 14	13-14			
Ø 15	15-16	3/8	100	24,00	50	45,75	Ø 15	15-16	3/8	100	46,50
Ø 18	17-18		100	25,50	50	48,00	Ø 18	17-18		100	48,00
Ø 20	19-20	1/2	100	27,00			Ø 20	19-20	1/2		
Ø 22	21-22		100	27,75	50	60,00	Ø 22	21-22		100	49,50
Ø 26	25-26						Ø 26	25-26	3/4	100	52,50
Ø 28	27-28	3/4	100	30,75	50	66,00	Ø 28	27-28		100	54,00
Ø 32	31-32	1"	100	36,00			Ø 32	31-32	1"		
Ø 35	34-35		100	38,25			Ø 35	34-35		100	58,50

**ABRAÇADEIRAS KVDA
PARA CONDUTAS DE VENTILAÇÃO
DE GRANDES DIMENSÕES**



• ZINCADAS

• FABRICADO EM CHAPA 28x2,5 mm



DIÂMETRO APERTO [mm]		ZINCADO	DIÂMETRO APERTO [mm]		ZINCADO
Ø 80	50	131,99	Ø 450	50	374,85
Ø 100	50	139,05	Ø 500	50	426,83
Ø 125	50	146,13	Ø 550	50	480,80
Ø 140	50	150,05	Ø 560	50	512,22
Ø 150	50	156,33	Ø 630	50	530,78
Ø 160	50	158,70	Ø 700	50	582,75
Ø 180	50	163,41	Ø 800	50	658,35
Ø 200	50	183,83	Ø 900	50	847,35
Ø 250	50	211,05	Ø 1000	50	1023,75
Ø 300	50	231,53	Ø 1100	50	1316,70
Ø 350	50	267,75	Ø 1200	50	1378,13
Ø 400	50	324,45	Ø 1250	50	1400,63

**GRAPAS
SIMPLES, EM "U", DUPLAS**



• ZINCADAS



DIMENSÕES		SIMPLES		EM "U"		DUPLAS	
DIÂMETRO	MEDIDA ["]		PREÇO		PREÇO		PREÇO
Ø 8		100	3,30	100	4,05		
Ø 10	1/8	100	3,45	100	4,35		
Ø 12		100	3,75	100	4,80		
Ø 14	1/4	100	4,20	100	4,95		
Ø 15		100	4,35	100	6,45		
Ø 16		100	4,35	100	6,60	100	9,60
Ø 18	3/8	100	6,15	100	7,35		
Ø 20		100	6,30	100	7,80	100	14,40
Ø 22	1/2	100	6,60	100	8,10		
Ø 24				100	9,90		
Ø 25		100	6,90			100	17,10
Ø 26	3/4	100	7,35	100	10,50		
Ø 28		100	8,25	100	11,10		
Ø 30		100	13,05	100	12,00		
Ø 32	1"	100	13,20	50	12,30	100	21,00
Ø 37		50	16,20	50	18,00		
Ø 40		50	16,35	50	18,30		
Ø 42	1 1/4	50	16,80	50	19,50		
Ø 47	1 1/2	50	24,00	50	20,40		
Ø 50		50	24,75	50	22,95		
Ø 54				50	35,40		
Ø 63	2"			50	38,55		
Ø 75	2 1/2			50	50,85		
Ø 90	3"			50	57,00		

CINTA PERFURADA ONDULADA

PARA FIXAÇÃO DE GRUPOS DE CONDUTORES, CONDUTAS E TUBOS EM GERAL



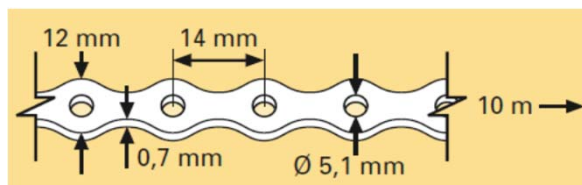

É fornecida embalada em caixa de plástico.

Ref.^a
54112

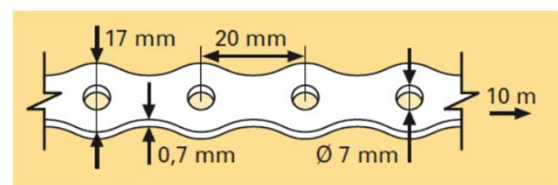

Ref.^a s
54116 e 54121



Ref. ^a	Material	Espessura	Largura	Comprim. Total	Entre furos	Ø Furos		Preço/ Rolo
54112	Chapa Galvan.	0,7 mm	12 mm	10 m	14 mm	5,1 mm	1	4,30
54116	Chapa Galvan.	0,7 mm	17 mm	10 m	19,8 mm	6,8 mm	1	5,70
54121	Chapa INOX	0,7 mm	17 mm	10 m	19,8 mm	6,8 mm	1	16,00

CALHAS PERFURADAS ZINCADO



• ZINCADO

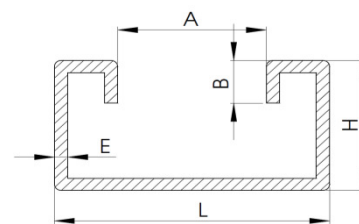

SECÇÃO 20 x 10 x 1	SECÇÃO 27 x 18 x 1,25	SECÇÃO 28 x 30 x 1,8
SECÇÃO 38 x 40 x 2	SECÇÃO 40 x 20 x 1,5	SECÇÃO 41 x 21 x 2
SECÇÃO 41 x 21 x 2,5	SECÇÃO 41 x 41 x 2	SECÇÃO 41 x 41 x 2,5

CALHA	DIMENSÕES					COMPRIMENTO		Preço /unid.	Preço /metro
	L	H	E	A	B				
20 x 10 x 1	20	10	10	10,5		2000	1	2,75	1,37
27 x 18 x 1,25	27	18	1,25	15		2000	1	3,14	1,57
28 x 30 x 1,8	28	30	1,8	15		2000	1	5,18	2,59
38 x 40 x 2	38	40	2	22,3	7	2000	1	6,69	3,35
40 x 20 x 1,5	40	20	1,5	22,3	7	2000	1	4,29	2,14
41 x 21 x 2	41,3	21,8	2	22,3	7	3000	1	8,26	2,75
41 x 21 x 2,5	41,3	21,8	2,5	22,3	7	3000	1	9,76	3,25
41 x 41 x 2	41,3	41,3	2	22,3	7	3000	1	12,83	4,28
41 x 41 x 2,5	41,3	41,3	2,5	22,3	7	3000	1	16,67	5,56

SUPORTES PERFURADOS ZINCADOS



• ZINCADO

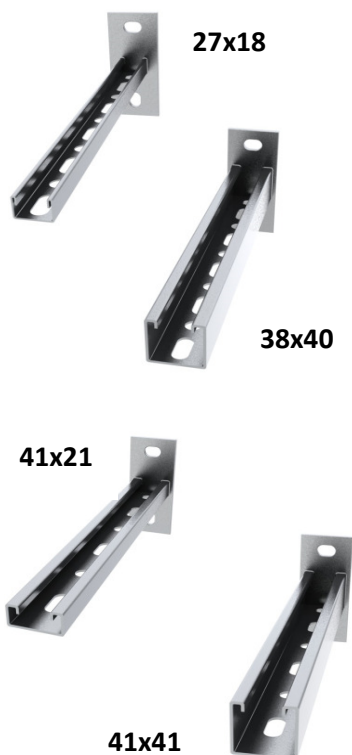

DIMENSÕES	DIMENSÕES DA PLACA	COMPRIMENTO		Preço €/Unidade
27 x 18 x 1,25	120 x 50 x 5	200	10	1,97
		300	10	2,04
38 x 40 x 2	120 x 50 x 5	300	10	2,64
		400	10	3,17
		500	10	3,32
		600	10	3,44
41 x 21 x 2,5	120 x 50 x 5	150	10	1,70
		300	10	2,08
		450	10	2,31
41 x 41 x 2,5	120 x 50 x 5	150	10	1,89
		300	10	2,66
		450	10	3,07
		600	10	3,45
		750	10	3,64
		1000	10	4,78

ESQUADROS PARA CALHAS PERFURADAS ZINCADOS



• ZINCADO

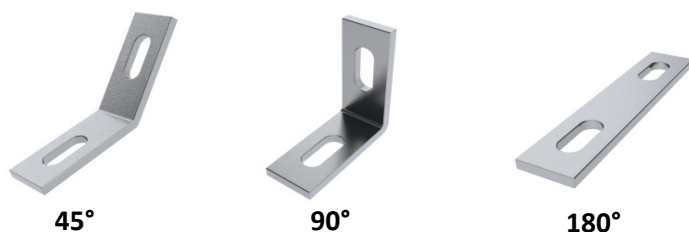

ÂNGULO		Preço €/Unidade
45°	100	0,76
90°	100	0,66
180°	100	0,58

SUPORTE BASE PARA CALHAS PERFURADAS ZINCADO



• ZINCADO



DIMENSÕES	PARA CALHAS		Preço €/Unidade
145 x 70 x 5	41x21, 41x41 e 41x62	10	5,18

**PARAFUSOS PARA
CALHAS PERFORADAS
ZINCADO**



• ZINCADO



CABEÇA PLANA



CABEÇA COM NERVURAS

TIPO	TAMANHO	PARA CALHAS		Preço €/Unidade
CABEÇA PLANA	M6x20	27x18 e 28x30	100	0,19
	M8x30		100	0,24
	M8x30	38x40	100	0,35
	M8x40		100	0,37
	M10x30		100	0,37
	M10x40		100	0,37
CABEÇA COM NERVURAS	M8x40	41x21, 41x41 e 41x62	100	0,35
	M10x40		100	0,37
	M12x50		100	0,46

**PORCAS PARA
CALHAS PERFORADAS
ZINCADO**



• ZINCADO



PLANA



COM NERVURAS



COM MOLA

TIPO	TAMANHO	PARA CALHAS		Preço €/Unidade	
PLANA	M6	20x10 e 25x8	100	0,08	
	M8		100	0,08	
	M6	25x8, 27x18 e 28x30	100	0,07	
	M8		100	0,07	
	M10		100	0,07	
		M8	38x40	100	0,15
		M10		100	0,15
COM NERVURAS	M8	41x21 e 41x41	100	0,15	
	M10		100	0,17	
	M12		100	0,18	
COM MOLA	13	41x21	M8	100	0,16
			M10	100	0,16
			M12	100	0,18
	33 - 38	41x41	M8	100	0,16
			M10	100	0,16
			M12	100	0,18

CALÇADO DE SEGURANÇA
QUALIDADE SUPERIOR
-USO PROFISSIONAL-

IONEER

CE

EN ISO 20345:2004/A1:2007
 S1P

MODELO UC-145

Resistente aos óleos



CARACTERÍSTICAS:

- Fabricado em pele de búfalo;
- Design moderno;
- Forro respirável em Campela;
- Palmilha microporosa - excelente circulação de ar;
- Calcanhar reforçado;
- Tacão amortecedor - absorção de energia no calcanhar - redução da fadiga;
- Biqueira larga com protecção de aço - reduz a possibilidade de doenças dermatológicas;
- Resistente à perfuração;
- Antiestática;
- Sola: PU/PU resistente aos óleos.



TIPO C - Bota baixa

CALÇADO DE SEGURANÇA - Biqueira resistente a impactos 200 J e compressão 15 kN.

CLASSE I - Fabricado em couro

TAMANHOS								PREÇO
39	40	41	42	43	44	45	46	29,00

CALÇADO DE SEGURANÇA
QUALIDADE SUPERIOR
-USO PROFISSIONAL-

IONEER

CE

EN ISO 20345:2004/A1:2007
 S1P

MODELO UC-143

Resistente aos óleos



CARACTERÍSTICAS:

- Fabricado em pele de búfalo;
- Design moderno;
- Forro respirável em Campela;
- Palmilha microporosa - excelente circulação de ar;
- Calcanhar reforçado;
- Tacão amortecedor - absorção de energia no calcanhar - redução da fadiga;
- Biqueira larga com protecção de aço - reduz a possibilidade de doenças dermatológicas;
- Resistente à perfuração;
- Antiestática;
- Sola: PU/PU resistente aos óleos.



TIPO A - Sapato

CALÇADO DE SEGURANÇA - Biqueira resistente a impactos 200 J e compressão 15 kN.

CLASSE I - Fabricado em couro

TAMANHOS								PREÇO
39	40	41	42	43	44	45	46	28,00

CALÇADO DE SEGURANÇA
QUALIDADE SUPERIOR
-USO PROFISSIONAL-



EN ISO 20345:2004/A1:2007
S1P

MODELO UE-411-1



TIPO B - Bota baixa

CALÇADO DE SEGURANÇA - Biqueira resistente a impactos 200 J e compressão 15 kN.

CLASSE I - Fabricado em couro

CARACTERÍSTICAS:

*Resistente aos óleos
e aos ácidos*

- Fabricado em pele camurça;
- Design moderno;
- Forro respirável em Air Mesh;
- Palmilha microporosa - excelente circulação de ar;
- Calcanhar reforçado;
- Tacão amortecedor - absorção de energia no calcanhar - redução da fadiga;
- Biqueira larga com proteção de aço - reduz a possibilidade de doenças dermatológicas;
- Resistente à perfuração;
- Antiestática;
- Sola: PU/PU resistente aos óleos e aos ácidos;
- Com elementos reflectores.

TAMANHOS											PREÇO	
37	38	39	40	41	42	43	44	45	46	47	48	38,00

CALÇADO DE SEGURANÇA
QUALIDADE SUPERIOR
-USO PROFISSIONAL-



EN ISO 20345:2004/A1:2007
S1P

MODELO UE-411



TIPO A - Sapato

CALÇADO DE SEGURANÇA - Biqueira resistente a impactos 200 J e compressão 15 kN.

CLASSE I - Fabricado em couro

CARACTERÍSTICAS:

*Resistente aos óleos
e aos ácidos*

- Fabricado em pele camurça;
- Design moderno;
- Forro respirável em Air Mesh;
- Palmilha microporosa - excelente circulação de ar;
- Calcanhar reforçado;
- Tacão amortecedor - absorção de energia no calcanhar - redução da fadiga;
- Biqueira larga com proteção de aço - reduz a possibilidade de doenças dermatológicas;
- Resistente à perfuração;
- Antiestática;
- Sola: PU/PU resistente aos óleos e aos ácidos;
- Com elementos reflectores.

TAMANHOS											PREÇO	
37	38	39	40	41	42	43	44	45	46	47	48	36,00

CALÇADO DE SEGURANÇA
QUALIDADE SUPERIOR
-USO PROFISSIONAL-



EN ISO 20345:2004/A1:2007
S3

MODELO UR-667

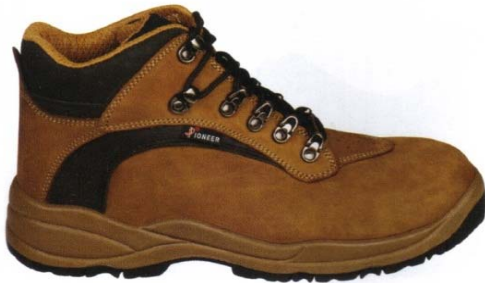

TIPO B - Bota baixa

CALÇADO DE SEGURANÇA - Biqueira resistente a impactos 200 J e compressão 15 kN.

CLASSE I - Fabricado em couro

CARACTERÍSTICAS:

- Fabricado em couro nobuck;
- Design moderno;
- Forro respirável em Campela;
- Palmilha microporosa - excelente circulação de ar;
- Calcanhar reforçado;
- Tacão amortecedor - absorção de energia no calcanhar - redução da fadiga;
- Biqueira larga com protecção de aço - reduz a possibilidade de doenças dermatológicas;
- Resistente à perfuração;
- Antiestática;
- Sola: PU/PU resistente aos óleos.

*Resistente aos óleos
 e aos ácidos*

S3: Igual a **S1P** com resistência à absorção e penetração de água.

TAMANHOS									PREÇO
39	40	41	42	43	44	45	46	47	50,00

CALÇADO DE SEGURANÇA
QUALIDADE SUPERIOR
-USO PROFISSIONAL-



EN ISO 20345:2004/A1:2007
S3

MODELO UR-666



TIPO A - Sapato

CALÇADO DE SEGURANÇA - Biqueira resistente a impactos 200 J e compressão 15 kN.

CLASSE I - Fabricado em couro

CARACTERÍSTICAS:

- Fabricado em couro nobuck;
- Design moderno;
- Forro respirável em Campela;
- Palmilha microporosa - excelente circulação de ar;
- Calcanhar reforçado;
- Tacão amortecedor - absorção de energia no calcanhar - redução da fadiga;
- Biqueira larga com protecção de aço - reduz a possibilidade de doenças dermatológicas;
- Resistente à perfuração;
- Antiestática;
- Sola: PU/PU resistente aos óleos.

*Resistente aos óleos
 e aos ácidos*

S3: Igual a **S1P** com resistência à absorção e penetração de água.

TAMANHOS									PREÇO
39	40	41	42	43	44	45	46	47	47,00

**CALÇADO DE SEGURANÇA
QUALIDADE PREMIUM
-USO PROFISSIONAL-**



**MODELO L-7328
- PREMIUM -**

**CATEGORIA
S1P SRC**



Ilhós com reforço interior



SRC = SRA + SRB (Sola antideslizante)

- Gáspea:** Camurça de vaca de alta qualidade
- Forro:** Malha BK resistente à abrasão
- Palmilha:** Em EVA respirável
- Sola:** Injetada PU / PU duas densidades
- Testagem:** Intertek lab - UK (Approved body:0362)
- Biqueira:** Compósito resistente a impacto 200 J
- Perfuração:** Placa de Kevlar resistente a 1100 Newtons

SRC		
SRC (SRA+SRB)		
		Sola 81 PU - PU
SRA CERÂMICA + ÁGUA	PLANTA ≥ 0.32 TACÃO (INCLINAÇÃO 7°) ≥ 0.28	0.52 0.48
SRB AÇO + GLICERINA	PLANTA ≥ 0.18 TACÃO (INCLINAÇÃO 7°) ≥ 0.13	0.23 0.18

EN ISO 20345:2011

- RESISTENTE A IMPACTOS 200 J**
- ANTI-DERRAPANTE**
- TACÃO AMORTECEDOR**
- ANTIESTÁTICO**
- RESISTENTE AO PETRÓLEO E AOS QUÍMICOS**
- RESISTENTE À PERFURAÇÃO**
- RESISTENTE AOS ÓLEOS**
- DESCARGA ELETROSTÁTICA**

TIPO A - Sapato

CALÇADO DE SEGURANÇA - Biqueira resistente a impactos 200 J e compressão 15 kN.

CLASSE I - Fabricado em couro

TAMANHOS												PREÇO	
36	37	38	39	40	41	42	43	44	45	46	47	48	45,00

CALÇADO DE SEGURANÇA
QUALIDADE PREMIUM
-USO PROFISSIONAL-



ART NO: L-7501
 SIZE: 40EU/7US/6UK
 COLOR: YELLOW
 STANDARD: S1P SRC



CE EN-20345:2011

MODELO L-7501

- PREMIUM -

CATEGORIA

S1P SRC



Cores disponíveis:

- Amarelo
- Verde
- Vermelho

SRC = SRA + SRB (Sola antideslizante)

- Gáspea:** Tecido Sanvlar-tech - impermeável
- Forro:** Malha sandwich ventilada e respirável
- Palmilha:** Em EVA respirável e confortável
- Sola:** Injetada PU / PU duas densidades
- Testagem:** UK SGS Lab (Approved body:0120)
- Biqueira:** Em aço, resistente a impacto 200 J
- Perfuração:** Placa de aço, resistente a 1100 Newtons

SRC		
SRC (SRA+SRB)		
		Sola 81 PU - PU
SRA CERÂMICA + ÁGUA	PLANTA ≥ 0.32 TACÃO (INCLINAÇÃO 7°) ≥ 0.28	0.52 0.48
SRB AÇO + GLICERINA	PLANTA ≥ 0.18 TACÃO (INCLINAÇÃO 7°) ≥ 0.13	0.23 0.18

EN ISO 20345:2011



RESISTENTE A IMPACTOS 200 J



ANTI-DERRAPANTE



TACÃO AMORTECEDOR



ANTIESTÁTICO



RESISTENTE AO PETRÓLEO E AOS QUÍMICOS



RESISTENTE À PERFURAÇÃO



RESISTENTE AOS ÓLEOS



DESCARGA ELETROSTÁTICA

TIPO A - Sapato

CALÇADO DE SEGURANÇA - Biqueira resistente a impactos 200 J e compressão 15 kN.

CLASSE II - Fabricado em materiais poliméricos

TAMANHOS													PREÇO
36	37	38	39	40	41	42	43	44	45	46	47	48	45,00

**CALÇADO DE SEGURANÇA
QUALIDADE PREMIUM
-USO PROFISSIONAL-**



Top Quality Creative Design
Amazing Comfort

Cool Air Max
Relax Fitting

BATCH NO. - 202382001

safetoe
TOP QUALITY SINCE 1984

Art No: M-8370

Color: Standard:
Brown | S3 SRC HRO

ASTM F2413-18 M I/75 C/75 PR

EN ISO 20345:2011

Size: 38 EU / 4UK / 5US

MODELO M-8370
- PREMIUM -

CATEGORIA
S3 SRC / HRO

**NOVO
DESIGN**



**+300°
HOT
RESISTANT**

**100%
METAL FREE**

**24 Hours
Water
Resistant**

Breathable



**18 KV
Electric Hazard
Insulation Performance**

S3: Igual a **S1P** com resistência à absorção e penetração de água.

SRC = SRA + SRB (Sola antideslizante)

HRO - Sola resistente a 300 °C

- Gáspea:** Couro nobuck integral de alta qualidade
- Forro:** Tela respirável e resistente à abrasão
- Palmilha:** Em EVA respirável e antiestática
- Sola:** Injetada PU / Borracha
- Testagem:** Intertek lab - UK (Approved body:0362)
- Biqueira:** Compósito resistente a impacto 200 J
- Perfuração:** Placa de Kevlar resistente a 1100 Newtons

SRC		
SRC (SRA+SRB)		
		Sola 81 PU - PU
SRA CERÂMICA + ÁGUA	PLANTA ≅ 0.32 TACÃO (INCLINAÇÃO 7°) ≅ 0.28	0.52 0.48
SRB AÇO + GLICERINA	PLANTA ≅ 0.18 TACÃO (INCLINAÇÃO 7°) ≅ 0.13	0.23 0.18

EN ISO 20345:2011

RESISTENTE A IMPACTOS 200 J	ANTI-DERRAPANTE	TACÃO AMORTECEDOR	ANTIESTÁTICO	RESISTENTE AO PETRÓLEO E AOS QUÍMICOS	RESISTENTE À PERFURAÇÃO	RESISTENTE À ÁGUA	RESISTENTE AOS ÓLEOS	DESCARGA ELETROSTÁTICA

TIPO B - Bota baixa

CALÇADO DE SEGURANÇA - Biqueira resistente a impactos 200 J e compressão 15 kN.

CLASSE I - Fabricado em couro

TAMANHOS												PREÇO	
36	37	38	39	40	41	42	43	44	45	46	47	48	60,00

**CALÇADO DE SEGURANÇA
QUALIDADE PREMIUM
-USO PROFISSIONAL-**



Top Quality Creative Design
Amazing Comfort

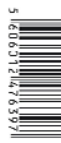

Art No: **M-8387**

Color: Black | Standard: S3S SR CI HI FO HRO
ASTM F2413-18 M I/75 C/75 PR

CE EN ISO 20345:2022

Size: 39 EU / 5 UK / 6US



**MODELO M-8387
- PARA SOLDADURA -**

**CATEGORIA
S3S SR CI HI FO HRO**



S3S: Resistente à perfuração com palmilha não metálica; **SR:** Sola antiderrapante;
CI: Resistente ao frio; **HI:** Resistente ao calor; **FO:** Resistente aos Fuelóleos;
HRO - Sola resistente a 300 °C

- Gáspea:** Couro de vaca negro resistente à água com cobertura anti salpicos em couro
- Forro:** Tela respirável e resistente à abrasão
- Palmilha:** Espuma com memória superior
- Sola:** Injetada PU / Borracha (HRO 300 °C)
- Testagem:** Intertek lab - UK (Appoved body:0362)
- Biqueira:** Compósito resistente a impacto 200 J
- Perfuração:** Placa de Kevlar resistente a 1100 Newtons

SRC		
SRC (SRA+SRB)		
		Sola 81 PU - PU
SRA CERÂMICA + ÁGUA	PLANTA ≥ 0.32 TACÃO (INCLINAÇÃO 7°) ≥ 0.28	0.52 0.48
SRB AÇO + GLICERINA	PLANTA ≥ 0.18 TACÃO (INCLINAÇÃO 7°) ≥ 0.13	0.23 0.18

EN ISO 20345:2011



RESISTENTE A IMPACTOS 200 J



ANTI-DERRAPANTE



TACÃO AMORTECEDOR



ANTIESTÁTICO



RESISTENTE AO PETRÓLEO E AOS QUÍMICOS



RESISTENTE À PERFURAÇÃO



RESISTENTE À ÁGUA



RESISTENTE AOS ÓLEOS



DESCARGA ELETROSTÁTICA

TIPO B - Bota baixa

CALÇADO DE SEGURANÇA - Biqueira resistente a impactos 200 J e compressão 15 kN.

CLASSE I - Fabricado em couro

TAMANHOS											PREÇO		
36	37	38	39	40	41	42	43	44	45	46	47	48	65,00

LUVAS DE PROTEÇÃO MODELO N119 - NITRILO



MODELO N119 LUVA EM MALHA DE NYLON COM PALMA E DEDOS REVESTIDOS A NITRILO



CARACTERÍSTICAS:

- Luva em malha #13 sem costuras 100% Nylon, com revestimento de Nitrilo na palma e nos dedos;
- Leves, boa destreza;
- Boa aderência;
- Não causa alergias;
- Transpirável / boa ventilação;
- Não utilizar para o manuseamento de derivados do petróleo.

APLICAÇÕES:

- Ideal para o sector da construção;
- Manuseamento de madeira e carpintaria;
- Sector agrícola;
- Manuseamento de materiais e peças;
- Manutenção;
- Embaladores.

CLASSIFICAÇÃO SEGUNDO A NORMA EN 388: 2016

Resistência à abrasão	Nível 4
Resistência ao corte por lâmina	Nível 1
Resistência ao rasgamento	Nível 2
Resistência à perfuração	Nível 1
Resistência ao corte (TDM)	X

		TAMANHOS					PREÇO
		7	8	9	10	11	
12 Pares	10x12 Pares						0,79

LUVAS DE PROTEÇÃO MODELO N120-G - NITRILO



MODELO N120-G LUVA EM MALHA DE NYLON CINZENTO COM PALMA E DEDOS REVESTIDOS A NITRILO



CARACTERÍSTICAS:

- Luva em malha #13 sem costuras 100% Nylon, com revestimento de Nitrilo na palma e nos dedos;
- Leves, boa destreza;
- Boa aderência;
- Não causa alergias;
- Transpirável / boa ventilação;
- Não utilizar para o manuseamento de derivados do petróleo.

APLICAÇÕES:

- Ideal para o sector da construção;
- Manuseamento de madeira e carpintaria;
- Sector agrícola;
- Manuseamento de materiais e peças;
- Manutenção;
- Embaladores.

CLASSIFICAÇÃO SEGUNDO A NORMA EN 388: 2016

Resistência à abrasão	Nível 4
Resistência ao corte por lâmina	Nível 1
Resistência ao rasgamento	Nível 2
Resistência à perfuração	Nível 1
Resistência ao corte (TDM)	X

		TAMANHOS					PREÇO
		7	8	9	10	11	
12 Pares	10x12 Pares						0,82

LUVAS DE PROTECÇÃO MODELO PV90A - PVC



MODELO PV90A LUA TOTALMENTE REVESTIDA A PVC SOBRE FORRO DE ALGODÃO COM PUNHO ELÁSTICO EM MALHA



CARACTERÍSTICAS:

- Totalmente revestida em PVC vermelho;
- Forro interior em algodão para maior comodidade;
- Punho elástico em malha;
- Boa resistência à abrasão.

APLICAÇÕES:

- Manipulação de hidrocarbonetos, produtos químicos e massa consistente;
- Manejo de materiais húmidos;
- Indústria pesqueira.

CLASSIFICAÇÃO SEGUNDO A NORMA EN 388

Resistência à abrasão	Nível 3
Resistência ao corte por lâmina	Nível 1
Resistência ao rasgamento	Nível 2
Resistência à perfuração	Nível 1

		TAMANHOS					PREÇO
		7	8	9	10	11	1,10
12 Pares	10x12 Pares						

LUVAS DE PROTECÇÃO MODELO PV91 - PVC



MODELO PV91 LUA TOTALMENTE REVESTIDA A PVC SOBRE FORRO DE ALGODÃO COM ANTEBRAÇO



CARACTERÍSTICAS:

- Totalmente revestida em PVC vermelho;
- Forro interior em algodão para maior comodidade;
- 35 ou 45 cm de comprimento;
- Protecção do antebraço;
- Boa resistência à abrasão.

APLICAÇÕES:

- Manipulação de hidrocarbonetos, produtos químicos e massa consistente;
- Manejo de materiais húmidos;
- Indústria pesqueira.

CLASSIFICAÇÃO SEGUNDO A NORMA EN 388

Resistência à abrasão	Nível 4
Resistência ao corte por lâmina	Nível 1
Resistência ao rasgamento	Nível 2
Resistência à perfuração	Nível 1

		TAMANHOS				PREÇO
		L= 35 cm	9	10	11	1,60
12 Pares	10x12 Pares	L= 45 cm	9	10	11	2,20

LUVAS DE PROTECÇÃO H5 pro



DISFRUTE DA EXPERIÊNCIA H5 pro

H5 é uma companhia especializada no design e produção de luvas procurando cobrir todas as necessidades que se possam deparar no desempenho de qualquer actividade. Trabalhando com uma ampla gama de materiais e soluções de última geração é possível garantir a máxima qualidade e oferecer um design inovador e vanguardista.

As luvas **H5** proporcionam não só estética e protecção como se comprometem em ir muito mais além e potenciar as qualidades mecânicas da mão humana. A mão humana é a mais completa e versátil ferramenta que existe na natureza. **H5** inova para que as suas luvas sejam não só o complemento perfeito da mão como também sejam um meio de melhorar algumas das suas capacidades.

PRINCIPAIS USOS E APLICAÇÕES

Ambientes húmidos	Reparação de veículos	Transporte	Canalização
Contacto com a água	Mecânica de competição	Pintura	Propriedades antiestáticas
Anticorte	Operadores de maquinaria industrial	Construção e alvenaria	Extra agarre
Manipulação de chapas	Ferramentas de vibração	Uso de ferramentas	Alta visibilidade
Indústria e instalação de vidro	Ferramentas de ar comprimido	Ferramentas de percussão	Impermeável
Linhas de montagem industrial	Armazenagem	Trabalhos de precisão	Resistência aos hidrocarbonetos e aos óleos

PRINCIPAIS MATERIAIS UTILIZADOS

<p>PU</p> <p>Imersão em Poliuretano. Confere qualidades antiestáticas à luva. Mantém os níveis de destreza altos.</p>	<p>NITRILE</p> <p>Imersão em Nitrilo. Resistência ao contacto com óleos e outros agentes químicos. Utilizado em luvas para múltiplos tipos de tarefas.</p>	<p>Latino</p> <p>Pele sintética de alta qualidade produzida no Japão com renome mundial. Transpirável, durável e lavável. Amplamente utilizada em luvas de trabalhos técnicos e desportivos.</p>	<p>Gel Absorb</p> <p>Enchimento tipo gel que reduz drasticamente a energia produzida pelas vibrações. Usado em diversos campos: indústria, desportos tipo bicicleta de montanha, enduro...</p>
<p>Forward</p> <p>Composto de recobrimento à base de silicone que incrementa a capacidade de agarre e antideslizamento. Combinável com uma grande variedade de materiais.</p>	<p>Bignet</p> <p>Fibra artificial em elastano. Tem propriedades únicas de elasticidade e recuperação. Proporciona conforto, ajuste, adaptabilidade e liberdade de movimentos. Transpirável.</p>	<p>BEIHAI</p> <p>Pele natural genuína, transpirável e ajustável. Dá às mãos o máximo conforto e uma preensibilidade excelentes. Sistema especial de curtido que confere suavidade ao tacto característica.</p>	<p>Nova</p> <p>Neopreno termoconformado. Introduce flexibilidade e ajuste perfeito tanto nos nós dos dedos como no pulso. Utilizado na palma ajuda a reduzir as vibrações. Faz de escudo térmico em ambientes de água.</p>
<p>Protech.</p> <p>Pele sintética com uma grande flexibilidade, óptimos níveis de resistência aos agentes mecânicos, duradoura e lavável. Usada em luvas de trabalho, jardim, floresta e desporto.</p>	<p>INPAC</p> <p>Poliuretano laminado lavável, ajustável e duradouro. A principal virtude é a alta sensibilidade e suavidade que confere às luvas. Utilizado em tarefas de precisão e tacto tanto em trabalho como em desporto.</p>	<p>LATEX</p> <p>Imersão em latex. Proporciona à luva uma boa qualidade de agarre tanto em seco como em molhado. O Latex usado por H5 é sempre respeitador do meio ambiente.</p>	<p>KEVLAR DUPONT</p> <p>Kevlar é uma fibra que combina alta resistência com leveza e flexibilidade. Resistente ao corte e ao calor. Utilizado tanto como material principal, como capa adicional ou como reforço específico.</p>

LUVAS DE PROTECÇÃO - H5pro
EXPOSITOR TÉCNICO



EXPOSITOR TÉCNICO

Expositor Técnico



CONTEÚDO

MODELO	TAMANHO	QUANTIDADE
<i>Amigo</i>	L	5 pares
	XL	5 pares
<i>Montecarlo</i>	L	5 pares
	XL	5 pares
<i>Shetland</i>	L	5 pares
	XL	5 pares
<i>Gripper</i>	L	5 pares
	XL	5 pares



PREÇO

455,00

LUVAS DE PROTECÇÃO - H5pro
EXPOSITOR PROFISSIONAL



EXPOSITOR PROFISSIONAL

Expositor Profissional



CONTEÚDO

MODELO	TAMANHO	QUANTIDADE
<i>Amigo</i>	L	5 pares
	XL	5 pares
<i>Kerax</i>	L	5 pares
	XL	5 pares
<i>Nitrile Standard NYDD 01</i>	L	10 pares
	XL	10 pares
<i>Sandy Nitrile NYSD 01</i>	L	10 pares
	XL	10 pares



PREÇO

250,00

LUVAS DE PROTECÇÃO AMIGO



MODELO: AMIGO - Refª PA7606
LUA PARA TRABALHOS GENÉRICOS
DE BRICOLAGE

Amigo



Conforto: ★★★★★
Durabilidade: ★★★★★

Descrição:

Pele flor com grande tacto e elasticidade. Proporciona o tacto necessário para manipular ferramentas manuais e efectuar todo o tipo de montagens e instalações. Dorso em *Bignet* que proporciona a adaptabilidade qualquer que seja a forma da mão. Ajuste perfeito com velcro no punho.

Uso:

Montagens, instalações, alvenaria. Manipulação de materiais.

Materiais:

BEIHAI
Bignet

- 1 Suavidade e elasticidade
- 2 Transpirabilidade e destreza
- 3 Extra ajuste

Aplicações:



		TAMANHOS					PREÇO
		S	M	L	XL	XXL	7,00
12 Pares	10x12 Pares						

LUVAS DE PROTECÇÃO DRUZUS



Modelo: DRUZUS - Refª SL8282

DRUZUS



Conforto: ★★★★★
Durabilidade: ★★★★★

Descrição:

Grande conforto para longos períodos de utilização em tarefas genéricas. Alto nível de destreza com reforços na palma, dedos e pontos de contacto de uso de ferramentas. Pré-curvadas para encaixe perfeito. Fixação adicional para o pulso. Respirável.

Uso:

Uso de ferramentas manuais, montagem e tarefas de reparação mecânica, obras gerais e tarefas avançadas de bricolage.

Materiais:

INPAC *Bignet*

Aplicações:



		TAMANHOS					PREÇO
		S	M	L	XL	XXL	7,00
12 Pares	10x12 Pares						

LUVAS DE PROTECÇÃO MONTECARLO



Modelo: MONTECARLO - Refª PU7450
LUA COM ELEVADO TACTO, PRECISÃO E COMODIDADE

Montecarlo



Conforto: ★★★★★
Durabilidade: ★★★★★

Descrição:

Palma que incrementa o agarre natural da mão e permite uma sensibilidade elevada. Alta destreza. Bandas de alta visibilidade no dorso. Perfeita como luva de condutor. Transpirável.

Uso:

Montagens de precisão. Transporte. Logística. Electrónica.

Materiais: INPAC 1 Alta sensibilidade
Bignet 2 Alta visibilidade
3 Ajustável e elástico

Aplicações:



		TAMANHOS					PREÇO
		S	M	L	XL	XXL	11,00
12 Pares	10x12 Pares						

LUVAS DE PROTECÇÃO SHETLAND



Modelo: SHETLAND - Refª SL7606
UM NOVO NÍVEL PARA A INDÚSTRIA QUÍMICA
E MANIPULAÇÃO DE HIDROCARBONETOS

Shetland



Conforto: ★★★★★
Durabilidade: ★★★★★

Descrição:

Palma em pele sintética resistente aos óleos e aos hidrocarbonetos. Totalmente flexível, transpirável e lavável. Dorso de Spandex e fixação de velcro no punho para uma fixação perfeita.

Uso:

Gasolineiras, indústria química, mecânica e reparação.

Materiais: lafino 1 Palma óleo repelente
Bignet

Aplicações:



		TAMANHOS					PREÇO
		S	M	L	XL	XXL	11,50
12 Pares	10x12 Pares						

LUVAS DE PROTECÇÃO KERAX



Modelo: KERAX - Refª PU7469
LUA COM EXCELENTE AJUSTE, AGARRE, CONFORTO E PRECISÃO

Kerax



Descrição:

Agarre superior, reforços na palma para utilização de ferramentas. Elevada destreza. Perfeita para qualquer tarefa de armazenagem e manutenção geral.

Uso:

Trabalhos de precisão. Manutenção logística. Armazenagem. Montagens electrónicas.

Materiais: **INPAC** 1 Sensibilidade
Bignet 2 Protecções adicionais na palma
3 Banda reflectora

Aplicações:



Conforto: ★★★★★
Durabilidade: ★★★★★☆



		TAMANHOS					PREÇO
		S	M	L	XL	XXL	13,00
12 Pares	10x12 Pares						

LUVAS DE PROTECÇÃO GRIPPER



Modelo: GRIPPER - Refª SL8147
INCREMENTA A CAPACIDADE NATURAL DE AGARRE DA MÃO

Gripper



Descrição:

Capacidade adicional de agarre, dorso de neopreno para manter um escudo térmico em caso de humidade ou água. Fixação perfeita no punho e flexibilidade total.

Uso:

Utilização de ferramentas. Trabalhos em altura, manipulação e transporte.

Materiais: **Forward** 1 Extra aderência
Nova 2 Flexibilidade e isolamento térmico
lano 3 Adaptabilidade

Aplicações:

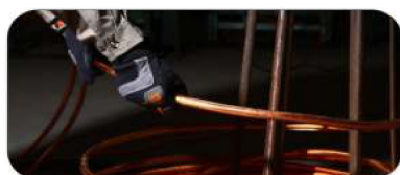

Conforto: ★★★★★
Durabilidade: ★★★★★☆



		TAMANHOS					PREÇO
		S	M	L	XL	XXL	16,00
12 Pares	10x12 Pares						

LUVAS DE PROTECÇÃO SPARTAN



Modelo: SPARTAN - Refª PA6001
EXCELENTE SOLUÇÃO PARA UTILIZAÇÃO COM MÁQUINAS

Spartan



Conforto: ★★★★★
Durabilidade: ★★★★★

Descrição:

Luva com dedos livres totalmente em pele flor. Interior com *GelAbsorb* que absorve as vibrações produzidas pelas máquinas. Adaptável e muito cómoda.

Uso:

Todo o tipo de ferramentas eléctricas, pneumáticas ou de impacto. Ferramentas manuais. Mecânica.

Materiais: **BEIHAI** 1 Antivibração
GelAbsorb 2 Transpirável e elástico
3 Fácil ajuste

Aplicações:



		TAMANHOS					PREÇO
		S	M	L	XL	XXL	13,00

LUVAS DE PROTECÇÃO NITRILE-NYDD 01



MODELO: NITRILE- NYDD 01 - Refª NT2110
LUVA DE NYLON SEM COSTURAS
IMPREGNADA EM NITRILÓ

Nitrile-NYDD 01



Conforto: ★★★★★
Durabilidade: ★★★★★

Descrição:

Nitrilo com boa resposta em ambientes húmidos. Impermeável na zona coberta. Bom agarre.

Uso:

Manipulação de peças pequenas, aplicação de pinturas, trabalhos de canalização. Aplicação de azulejos e ladrilhos.

Materiais:

NITRILE

Aplicações:



		TAMANHOS					PREÇO
		S	M	L	XL	XXL	1,00

LUVAS DE PROTECÇÃO NITRILE-NYSD 01



MODELO: NITRILE-NYSD 01 - Refª NT5130
LUA SEM COSTURAS
IMPREGNADA EM NITRILÓ MICRORUGOSO

Nitrile-NYSD 01



Descrição:

Nitrilo microrugoso. Confere propriedades excelentes de agarre em ambientes húmidos mantendo intactas as propriedades da luva de nitrilo.

Uso:

Manutenção industrial.

Materiais:

NITRILE

Aplicações:



Conforto: ★★★★★
Durabilidade: ★★★★★



		TAMANHOS					PREÇO
		S	M	L	XL	XXL	2,00

LUVAS DE PROTECÇÃO NITRILE-NYFD 01



MODELO: NITRILE-NYFD 01 - Refª NT5008
LUA SEM COSTURAS
IMPREGNADA EM ESPUMA DE NITRILÓ

Nitrile-NYFD 01



Descrição:

Impregnação de espuma de Nitrilo sobre Nylon. Melhor sensibilidade que as restantes luvas de Nitrilo ao mesmo tempo que mantém as propriedades de impermeabilidade aos óleos e massas.

Uso:

Manutenção industrial com peças oleadas. Mecânica geral. Pintura. Acabamentos.

Materiais:

NITRILE

Aplicações:



Conforto: ★★★★★
Durabilidade: ★★★★★



		TAMANHOS					PREÇO
		S	M	L	XL	XXL	2,30

LUVAS DE PROTECÇÃO NITRILE-JYFD 01



MODELO: NITRILE-JYFD 01 - Refª NT5002
LUA TOTALMENTE IMPREGNADA EM NITRILÓ

Nitrile-JYFD 01



Conforto: ★★★★★
Durabilidade: ★★★★★

Descrição:

Luva totalmente impregnada. Punho elástico para melhor ajuste. Boa protecção tanto na palma como no dorso em ambiente oleosos.

Uso:

Trabalhos industriais vários. Construção. Aplicação de pinturas e revestimentos.

Materiais:

NITRILE

Aplicações:



CE	EN 388		TAMANHOS					PREÇO
			12 Pares	10x12 Pares	S	M	L	XL

LUVAS DE PROTECÇÃO LATEX-JYD 01



MODELO: LATEX- JYD 01 - Refª SK2102
LUA SEM COSTURAS
IMPREGNADA EM LATEX RUGOSO

Latex-JYD 01

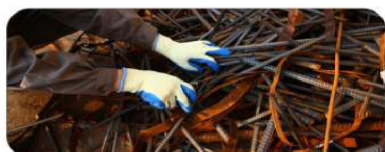

Conforto: ★★★★★
Durabilidade: ★★★★★

Descrição:

Luva sem costuras recoberta em latex rugoso. Bom agarre em ambientes secos e molhados.

Uso:

Construção e trabalhos de alvenaria. Trabalhos exigentes de bricolage.

Materiais:

LATEX

Aplicações:



CE	EN 388		TAMANHOS					PREÇO
			12 Pares	10x12 Pares	S	M	L	XL

LUVAS DE PROTECÇÃO FRIEND



MODELO: FRIEND - Refª CB3501
LUA TRADICIONAL DE TRABALHO
EM PELE DE VACA

Friend



Conforto: ★★★★★
Durabilidade: ★★★★★

Descrição:

Boa resistência à perfuração. Luva em pele de vaca com punho de segurança.

Uso:

Uso geral.

Materiais:

Aplicações:



CE	EN 388			TAMANHOS					PREÇO
				12 Pares	10x12 Pares	S	M	L	XL

LUVAS DE PROTECÇÃO PRIATEL



Modelo: PRIATEL - Refª CB3060
LUA DE PELE REFORÇADA

Priatel



Conforto: ★★★★★
Durabilidade: ★★★★★

Descrição:

Palma reforçada com pele de vaca. Punho reforçado para proteção adicional. Dorso em lona.

Uso:

Qualquer tarefa que implique risco de corte. Construção. Manipulação de chapas.

Materiais:

Aplicações:



CE	EN 388			TAMANHOS					PREÇO
				12 Pares	10x12 Pares	S	M	L	XL

LUVAS DE PROTEÇÃO LATEX - KEVELAR



Modelo: LATEX-KV1 - Refª SK210KL
LUVA DE KEVELAR SEM COSTURAS IMPREGNADO EM LATEX

Latex-KV1



Conforto: ★★★★★
Durabilidade: ★★★★★

Descrição:

Luva sem costuras recoberta de latex. Assegura um bom agarre tanto em situações de seco como molhado. As fibras de kevelar providenciam uma muito boa resistência tanto ao corte como à perfuração.

Uso:

Cercas, poda, tarefas florestais e agrícolas com risco de corte ou perfuração.

Materiais:



- 1 Latex
- 2 Estrutura Kevelar

Aplicações:



		TAMANHOS					PREÇO
		S	M	L	XL	XXL	12,00
12 Pares	10x12 Pares						



Materiais:

Aplicações:

		TAMANHOS					PREÇO

LUVAS DE PROTECÇÃO HYPROWER PU-HY1



MODELO:HYPROWER PU-HY1 - Refª SK2131
LUVAS ANTICORTE SEM COSTURAS

HYPROWER

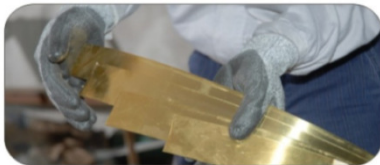

Conforto: ★★★★★
Durabilidade: ★★★★★

Descrição:

Luvras sem costuras em fibra HYPRO. Resistente à abrasão e ao corte. Bom ajuste e conforto em longos períodos de trabalho. A camada de PU permite a transpiração e aumenta a capacidade de agarrar.

Uso:

Indústria vidreira, construção, indústria automóvel, cablagem e vedação.

Materiais:

Hypro PU

Aplicações:



		TAMANHOS					PREÇO
		S	M	L	XL	XXL	11,00
12 Pares	10x12 Pares						

LUVAS DE PROTECÇÃO PU-NY-FD2



MODELO:PU-NY-FD2 - Refª PU2103
LUVA DE NYLON SEM COSTURAS
IMPREGNADA EM PU

PU-NY-FD2



Conforto: ★★★★★
Durabilidade: ★★★★★

Descrição:

Indicadas para qualquer tarefa de intensidade baixa/média em ambientes secos. Palma em PU.

Uso:

Trabalhos de precisão. Montagens menores. Instalação de cabos.

Materiais:

PU

Aplicações:



		TAMANHOS					PREÇO
		S	M	L	XL	XXL	1,20
12 Pares	10x12 Pares						

LUVAS DE PROTECÇÃO VESUVIUS



Modelo: VESUVIUS - Refª CB6501-14"
LUVAS PARA SOLDADURA COM PROTEÇÃO ANTICORTE

VESUVIUS



Conforto: ★★★★★
Durabilidade: ★★★★★

Descrição:

Couro de primeira qualidade. Espessura extra para proteção contra os salpicos de soldadura. Boa proteção anticorte e antiperfuração. Comprimento: 34 cm.

Uso:

Soldadura MMA. Manuseamento de peças cortantes.

Materiais: **BEIHAI**. 1 Proteção contra o calor, chispas e pequenas partículas.
KEVLAR® 2 Proteção contra o calor.

Aplicações:



CE	EN 388			TAMANHOS					PREÇO
				12 Pares	10x12 Pares	S	M	L	XL

LUVAS DE PROTECÇÃO ETNA



MODELO: ETNA - Refª GA6512
ELEVADO TACTO PARA TRABALHOS DE SOLDADURA TIG/MIG

ETNA



Conforto: ★★★★★
Durabilidade: ★★★★★

Descrição:

Lumas em pele que garantem elevada destreza. Sensibilidade e flexibilidade. Comprimento total: 33 cm. Proteção do antebraço em pele.

Uso:

Trabalhos de soldadura com Argon que requeiram elevado tacto.

Materiais: **BEIHAI**. 1 Pele flor de cabra.
KEVLAR® 2 Antebraço em pele de vaca.

Aplicações:



CE	EN 388			TAMANHOS					PREÇO
				12 Pares	10x12 Pares	S	M	L	XL

LUVAS DE PROTECÇÃO KRAFLA



Modelo: KRAFLA - Refª PA6564
PROTEÇÃO PARA TRABALHOS DE SOLDADURA COM ELEVADA SENSIBILIDADE

KRAFLA



Conforto: ★★★★★
Durabilidade: ★★★★★

Descrição:

Combinação de couro com pele flor. Forro protetor térmico que permite trabalhar em condições difíceis. Comprimento: 33 cm. Fio Kevlar.

Uso:

Trabalhos de soldadura difíceis e agressivos.

Materiais:

BEIHA! KEVLAR®

- 1 Bom tacto, pele flor.
- 2 Reforços em pele de vaca.
- 3 Costura em Kevlar.
- 4 Forro resistente ao calor.

Aplicações:



		TAMANHOS					PREÇO
		S	M	L	XL	XXL	14,00
12 Pares	10x12 Pares						

LUVAS DE PROTECÇÃO AKAB - PVC-JYLD01



MODELO: AKAB - PVC-JYLD01 - Refª PVC4010
LUA LONGA DE PVC SOBRE BASE DE ALGODÃO

AKAB



Conforto: ★★★★★
Durabilidade: ★★★★★

Descrição:

Palma em PVC granulado antideslizante. Forro interior em algodão sem costuras para maior comodidade. 30 cm de comprimento. Proteção do antebraço. Boa resistência à abrasão.

Uso:

Manipulação de hidrocarbonetos, produtos químicos e massa consistente. Manejo de materiais húmidos. Indústria pesqueira.

Materiais:

PVC

- 1 Acabamento granulado antideslizante.

Aplicações:



		TAMANHOS					PREÇO
		S	M	L	XL	XXL	3,80
12 Pares	10x12 Pares						

LUVAS DE PROTECÇÃO LUVAS DESCARTÁVEIS



MODELO: NITRILE-D1 - Refª NT003 LUA DESCARTÁVEL EM NITRIL COR AZUL

Nitrile-D1



Conforto: ★★★★★
Durabilidade: ★★★★★

Descartáveis

Descrição:

Bom agarre em ambientes húmidos e secos. Ambidextras. Melhor resistência que o Latex. Válidas para pessoas alérgicas ao Latex. Sem Pó. Disponíveis em dispensador de 100 unidades.

Uso:

Indústria química. Aplicação de fertilizantes. Electrónica e montagem.

		TAMANHOS					PREÇO €/Cx 100 Unid.
100 Unidades	10x100 Unidades	S	M	L	XL	XXL	11,50

MODELO: LATEX-D1 - Refª RB001 LUA DESCARTÁVEL EM LATEX SEM PÓ

Latex-D1



Conforto: ★★★★★
Durabilidade: ★★★★★

Descartáveis

Descrição:

Luva descartável. Sem pó. Ambidextra. Válida também para laboratórios, farmácias e uso médico. Disponíveis em dispensador de 100 unidades. AQL 1.5.

Uso:

Laboratórios. Inspeção e controlo. Farmácia. Pintura. Montagem.



		TAMANHOS					PREÇO €/Cx 100 Unid.
100 Unidades	10x100 Unidades	S	M	L	XL	XXL	11,50

Modelo: H5FLEX - VYNIL-D1 - Refª VN002 LUA DESCARTÁVEL EM VINIL TRANSPARENTE

H5FLEX



Conforto: ★★★★★
Durabilidade: ★★★★★

Descartáveis

Descrição:

Luva descartável impermeável ao ar e à água. Ausência de riscos de alergias. Ambidextra. Excelente tacto. Disponível em dispensador de 100 unidades. AQL 1,5.

Uso:

Manipulação de carburantes, dissolventes, óleos. Pinturas, tintas. Montagens de precisão.

		TAMANHOS					PREÇO €/Cx 100 Unid.
100 Unidades	10x100 Unidades	S	M	L	XL	XXL	7,50

LUVAS DE PROTEÇÃO - H5pro
GAMA JARDINAGEM, AGRICULTURA E
FLORESTA



PRINCIPAIS USOS E APLICAÇÕES

Uso específico para motosserras	Corte de madeira	Trabalhos em altura	Uso de roçadoras
Ambientes húmidos	Plantar e cuidar de flores. Tarefas básicas de jardim.	Limpeza de terrenos. Transplantar.	Sulfatar. Aplicação de inseticidas, fungicidas e adubos.
Agricultura. Maquinaria agrícola.	Ambientes de frio, neve e gelo.	Utilização de ferramentas manuais.	Poda profissional. Uso de corta sebes mecânicos.
Ganadaria. Trabalho com animais.	Cercas e vedações. Trabalhos com arame farpado.	Colheita de frutas e verduras.	Flores com espinhos.
Rega.			

LUVAS DE PROTEÇÃO
SHERPA
PARA MOTOSSERRA



EN 381-7



Modelo: SHERPA - Refª GA8912
LUA DE PROTEÇÃO PARA CORTE COM MOTOSSERRA

SHERPA



Descrição:

Luva específica para trabalhos com motosserra. Realizada a partir de pele natural com um padrão multimaterial para uma comodidade e um ajuste perfeito na mão. Boa comodidade para trabalhos contínuos. Proteção adicional na mão esquerda para o corte com motosserra.

Uso:

Operação profissional de motosserras. Trabalhos florestais

Materiais:

- BEIHAI** *Bignet* **Armortex** *Nova*
- 1 Transpirável e elástica
 - 2 Antideslizamento
 - 3 Adaptação extra
 - 4 Proteção motosserra

Aplicações:



Conforto: ★★★★★
Durabilidade: ★★★★★



		TAMANHOS					PREÇO
		S	M	L	XL	XXL	20,00
12 Pares	10x12 Pares						

LUVAS DE PROTEÇÃO AGROMASTER



MODELO: AGROMASTER - Refª SL8248
UM NOVO NÍVEL DE CONFORTO PARA QUALQUER ACTIVIDADE DE JARDINAGEM, PAISAGISMO, GANADARIA OU AGRICULTURA

AGROMASTER



Conforto: ★★★★★
Durabilidade: ★★★★★

Descrição:

Resposta perfeita em proteção e conforto graças aos seus reforços na palma da mão. Adaptabilidade total à mão graças ao elastano Bignet do dorso. Absolutamente recomendado para qualquer uso prolongado.

Uso:

Uso prolongado. Poda industrial, plantação, ganadaria, manipulação de maquinaria, uso de ferramentas manuais.

Materiais:

- 1 Protech - antiabrasão
- 2 SoftAbsorb

Bignet SoftAbsorb Protech.

- 3 Bignet - Elástico e flexível

Aplicações:



		TAMANHOS					PREÇO
		S	M	L	XL	XXL	9,00
12 Pares	10x12 Pares						

LUVAS DE PROTEÇÃO COLOSSUS



Modelo: COLOSSUS - Refª PB8010
EVOLUÇÃO DE UMA LUVA DE PELE TRADICIONAL

COLOSSUS



Conforto: ★★★★★
Durabilidade: ★★★★★

Descrição:

A palma em couro e o dorso em tecido Bignet proporcionam um ajuste e uma facilidade de manuseamento excelentes.

Uso:

Trabalhos exigentes em agricultura e criação de gado. Manuseamento de ferramentas, corte de lenha, cercas.

Materiais:

- 1 Palma: Couro
- 2 Dorso: Adaptável e elástico.

BEIHA! *Bignet*

Aplicações:



		TAMANHOS					PREÇO
		S	M	L	XL	XXL	6,00
12 Pares	10x12 Pares						

LUVAS DE PROTEÇÃO FIORE



MODELO: FIORE - Refª GA6565
ELEGÂNCIA, FLEXIBILIDADE E SUAVIDADE

FIORE



Conforto: ★★★★★
Durabilidade: ★★★★★

Descrição:

Luva com forma feminina de alta gama realizada com pele de primeira qualidade. Muito suave e flexível. Proteção nos nós dos dedos contra golpes ocasionais e proteção na zona dos pulsos para evitar arranhões antiestéticos. Tecido transpirável para evitar odores depois de um uso prolongado.

Uso:

Qualquer trabalho básico de jardinagem.

Materiais:

BEIHAI.

- 1 Transpirável e elástica.
- 2 Proteção extra.

Aplicações:



		TAMANHOS					PREÇO
		S	M	L	XL	XXL	9,00
12 Pares	10x12 Pares						

LUVAS DE PROTEÇÃO GRANDE FIORE



Modelo: GRANDE FIORE - Refª PA6608
ELEGÂNCIA, FLEXIBILIDADE E SUAVIDADE

GRANDE FIORE



Conforto: ★★★★★
Durabilidade: ★★★★★

Descrição:

Luva com forma feminina de alta gama realizada com pele de primeira qualidade. Muito suave e flexível. Proteção na zona dos pulsos e antebraços para evitar arranhões antiestéticos. Tecido transpirável para evitar odores depois de um uso prolongado.

Uso:

Qualquer trabalho básico de jardinagem.

Materiais:

BEIHAI.

- 1 Transpirável e elástica.
- 2 Proteção extra.

Aplicações:



		TAMANHOS					PREÇO
		S	M	L	XL	XXL	10,00
12 Pares	10x12 Pares						

LUVAS DE PROTEÇÃO FIORELLE



MODELO: FIORELLE - Refª 2400
LUVA BÁSICA PARA FAZER TAREFAS DE JARDINAGEM COM ESTILO

FIORELLE



Conforto: ★★★★★
Durabilidade: ★★☆☆☆

Descrição:

Fabricação totalmente em algodão. Palma recoberta com pontos de borracha para melhorar o agarre das ferramentas.

Uso:

Qualquer trabalho básico de jardinagem.

Materiais:

Algodão.

Aplicações:



		TAMANHOS					PREÇO
		S	M	L	XL	XXL	1,50

LUVAS DE PROTEÇÃO NT-Garden



Modelo: NT-GARDEN - Refª NT5010
LUVAS SEM COSTURAS

NT-GARDEN



Conforto: ★★★★★
Durabilidade: ★★☆☆☆

Descrição:

A tecnologia sem costuras dá-nos uma grande comodidade. Indicado para aplicação de inseticidas, fungicidas, fertilizantes. Bom comportamento em contacto com substâncias ácidas e alcalinas.

Uso:

Trabalhos de baixa e média intensidade. Sulfatação e rega.

Materiais:

NITRILE

Aplicações:



		TAMANHOS					PREÇO
		S	M	L	XL	XXL	2,50

**CAPACETE DE SEGURANÇA
EM ABS - 6 PONTOS
Ref.^a B201**



Ref.^a B201



Normas:

EN 397: 1995+A1:2000
ANSI Z89+



CARACTERÍSTICAS:

- Leve, fabricado em ABS, proporciona uma excelente proteção;
- Equipado com rede de tiras suspensa em 6 pontos para absorção de choques;
- Com ranhuras laterais para encaixar acessórios como viseiras, conchas auriculares e capacetes de soldar;
- Com ranhuras no topo para a saída de ar quente e um maior conforto em utilizações prolongadas.

Desempenho conforme Diretiva Europeia n.º 89/686/CEE
relativa aos Equipamentos de Proteção Individual;

	CORES			PREÇO
1 Unidade				4,50

**ÓCULOS DE SEGURANÇA
Ref.^a B501**



Ref.^a B501



Normas:

EN 106
EN 170
ANSI Z87+



CARACTERÍSTICAS:

- Lente de uma só peça com proteções laterais para proteger sem bloquear a visão;
- Sobreponível com óculos normais;
- Suporte nasal;
- Lente em policarbonato para garantir resistência a impactos;
- Proteção UV 385;
- Laterais ventiladas, permitem a circulação do ar, reduzindo o calor e evitando o embaciamento da lente.

Desempenho conforme Diretiva Europeia n.º 89/686/CEE
relativa aos Equipamentos de Proteção Individual;

			PREÇO
12 Unidades		1 Unidade	1,30

ÓCULOS DE SEGURANÇA
Ref.^a B502



Ref.^a B502



CARATERÍSTICAS:

- Ultra leve (22 g);
- Formato ergonómico envolvente para uma excelente proteção periférica;
- Suporte nasal elegante em borracha;
- Hastes com terminais macios para um excelente conforto;
- Lente em policarbonato para garantir resistência a impactos;
- Proteção UV 385;

Desempenho conforme Diretiva Europeia n.º
89/686/CEE
relativa aos Equipamentos de Proteção
Individual;

Normas:

EN 166
EN 170
ANSI Z87+



		PREÇO
12 Unidades	1 Unidade	2,70

ÓCULOS DE SEGURANÇA
Ref.^a B507



Ref.^a B507



CARATERÍSTICAS:

- Lente de uma só peça com abas laterais para proteger sem bloquear a visão;
- Suporte nasal moldado e ergonómico;
- Armação leve em nylon com hastes ajustáveis em comprimento;
- Lente em policarbonato para garantir resistência a impactos;
- Proteção UV 385.

Desempenho conforme Diretiva Europeia n.º
89/686/CEE
relativa aos Equipamentos de Proteção
Individual;

Normas:

EN 106
EN 170
ANSI Z87+



		PREÇO
12 Unidades	1 Unidade	1,45

**ÓCULOS DE SEGURANÇA
DE PROTEÇÃO TOTAL
Ref.^a B402**



Ref.^a B402



Normas:
EN 166
EN 166 N
ANSI Z87+





CARATERÍSTICAS:

- Proteção contra partículas grandes em operações de corte ou esmerilamento;
- Com ventilação indireta - anti embaciamento;
- Pode ser usado sobre óculos normais;
- Armação flexível, leve, com lentes em policarbonato.

Anti embaciamento

Desempenho conforme Diretiva Europeia n.º
89/686/CEE
relativa aos Equipamentos de Proteção
Individual;

		PREÇO
12 Unidades	1 Unidade	2,70

**ÓCULOS DE PROTEÇÃO TOTAL PARA
SOLDAR
Ref.^a B408**



Ref.^a B408



Normas:
EN 175
ANSI Z87+



CARATERÍSTICAS:

- Óculos panorâmicos de soldar com ecrã rebatível;
- Ventilação indireta;
- Banda elástica;
- Lente interior em policarbonato, lente exterior em vidro mineral;
- Tonalidade 5.

Desempenho conforme Diretiva Europeia n.º
89/686/CEE
relativa aos Equipamentos de Proteção
Individual;

	PREÇO
1 Unidade	3,60

**MÁSCARA DE SOLDAR
DE MÃOS LIVRES
Ref.^a B303**



Ref.^a B303



Mãos Livres

Normas:
EN 175 CE
ANSI Z87+



CARATERÍSTICAS:

- Fixação à cabeça ajustável, com a parte superior extensível;
- Protege de faíscas e salpicos;
- Máscara em polipropileno durável;
- Abertura da lente frontal para fácil avaliação da solda.

Desempenho conforme Diretiva Europeia n.º 89/686/CEE
relativa aos Equipamentos de Proteção Individual;

	PREÇO
1 Unidade	6,80

**CAPACETE DE SOLDAR
Ref.^a B338**



Ref.^a B338



Auto escurecimento

Normas:
EN 175
EN 379
ANSI Z87+



CARATERÍSTICAS:

- Controlo ajustável manual;
- Escurecimento, sensibilidade e tempo de ação variável;
- Sistema de ajuste garante conforto para o trabalho diário;
- Capacete leve e durável, resistente ao calor e a produtos químicos.
- Máscara em polipropileno durável;

Desempenho conforme Diretiva Europeia n.º 89/686/CEE
relativa aos Equipamentos de Proteção Individual;

	PREÇO
1 Unidade	60,00

WISEIRA EM MALHA DE AÇO Ref.^a B906SP



Ref.^a B906SP



CARATERÍSTICAS:

- Adequado para a proteção da face;
- Viseira em malha de aço e sobreposição de viseira parcial em policarbonato;
- Proteção ideal contra aparas de madeira e demais operações de jardinagem e agrícolas.
- Zona de aperto acolchoada para maior conforto;
- Possível de combinar com proteção auditiva (B003, B017, B020)

Desempenho conforme Diretiva Europeia n.º
89/686/CEE
relativa aos Equipamentos de Proteção
Individual;

Normas:

EN 166
EN 1731
ANSI Z87+



	PREÇO
1 Unidade	4,80

MÁSCARA RESPIRATÓRIA PARA PÓ Ref.^a B627



Ref.^a B627



Descartável

CARATERÍSTICAS:

- Clip para ajustar a máscara;
- Fabricado em Poliéster;
- Fácil utilização e armazenamento;
- Descartável, leve e económica;
- Apropriada para processos de lixagem, rectificação e limpeza geral.

Desempenho conforme Diretiva Europeia n.º
89/686/CEE
relativa aos Equipamentos de Proteção
Individual;

	PREÇO
10 Unidades	0,16
50 Unidades	0,14

**MÁSCARA RESPIRATÓRIA PARA PÓ
E AEROSSÓIS
Ref.^a B701 FFP1**



Ref.^a B701 FFP1

EN 149:2001+A1:2009



Normas:
EN 149:2001+A1:2009



CARACTERÍSTICAS:

- De acordo com a norma EN 149:2001+A1:2009;
- Fabricado em polipropileno;
- Clip para ajustar a máscara;
- Fácil utilização e armazenamento;
- Descartável, leve e económica;
- Adequada para processos de lixagem, rectificação, aerossóis e limpeza geral.

Desempenho conforme Diretiva Europeia n.º
89/686/CEE
relativa aos Equipamentos de Proteção
Individual;

		PREÇO
25 x 5 Unidades	5 Unidades	0,70

**MÁSCARA RESPIRATÓRIA PARA PÓ E
AEROSSÓIS COM VÁLVULA
Ref.^a B701V FFP1**



Ref.^a B701V FFP1

EN 149:2001+A1:2009



Normas:
EN 149:2001+A1:2009



CARACTERÍSTICAS:

- Válvula de expiração incorporada;
- Clip para ajustar a máscara e reduzir o embaciamento dos óculos;
- Fabricado em polipropileno;
- Descartável, leve e económica;
- Adequada para processos de lixagem, rectificação, aerossóis e limpeza geral;
- Elástico da cabeça sem latex.

Desempenho conforme Diretiva Europeia n.º
89/686/CEE
relativa aos Equipamentos de Proteção
Individual;

		PREÇO
25 x 5 Unidades	5 Unidades	1,00

**MÁSCARA RESPIRATÓRIA PARA PÓ, FUMOS
E AEROSSÓIS
Ref.^a B702 FFP2**



Ref.^a B702 FFP2

EN 149:2001+A1:2009



Normas:



EN 149:2001+A1:2009



CARACTERÍSTICAS:

- Proteção contra sólidos e líquidos não tóxicos em concentrações até 4xOEL ou 4xAPF;
- Clip para ajustar a máscara e reduzir o embaciamento dos olhos;
- Fabricado em polipropileno;
- Elástico da cabeça sem latex;
- Adequado para manipulação de cimento, celulose, metais, fungos, óleos minerais e vegetais.

Desempenho conforme Diretiva Europeia n.º
89/686/CEE
relativa aos Equipamentos de Proteção
Individual;

		PREÇO
25 x 5 Unidades	5 Unidades	0,80

**MÁSCARA RESPIRATÓRIA PARA PÓ, FUMOS
E AEROSSÓIS COM VÁLVULA
Ref.^a B702V FFP2**



Ref.^a B702V FFP2

EN 149:2001+A1:2009



Normas:



EN 149:2001+A1:2009



CARACTERÍSTICAS:

- Válvula de expiração permite uma melhor respiração em condições quentes e húmidas;
- Proteção contra sólidos e líquidos não tóxicos em concentrações até 4xOEL ou 4xAPF;
- Fabricado em polipropileno;
- Clip para ajustar a máscara e reduzir o embaciamento dos olhos;
- Elástico da cabeça sem latex.

Desempenho conforme Diretiva Europeia n.º
89/686/CEE
relativa aos Equipamentos de Proteção
Individual;

		PREÇO
25 x 5 Unidades	5 Unidades	1,15

PROTETOR AURICULAR
Ref.^a B003



Ref.^a B003



Normas:

EN352-1:2002 CE

ANSI S3.19

SNR: 25 dB



CARACTERÍSTICAS:

- Banda de cabeça ajustável;
- Tamanho universal;
- Leve, indicado para uso de longa duração;
- Auriculares podem ser usados em conjunto com proteção facial, sem necessidade de acessórios adicionais;
- Material: ABS e Poliacetal.

Desempenho conforme Diretiva Europeia n.º
89/686/CEE
relativa aos Equipamentos de Proteção
Individual;

	PREÇO
1 Unidade	3,80

PROTETOR AURICULAR
Ref.^a B020



Ref.^a B020



Normas:

EN352-1:2002 CE

SNR: 27 dB



CARACTERÍSTICAS:

- Banda acolchoada para maior conforto;
- Zona das orelhas almofadada;
- Banda de cabeça ajustável;
- Tamanho universal;
- Leve, indicado para uso de longa duração;
- Material: ABS e Poliacetal.

Desempenho conforme Diretiva Europeia n.º
89/686/CEE
relativa aos Equipamentos de Proteção
Individual;

	PREÇO
1 Unidade	4,00

**PROTETOR AURICULAR
ERGONÓMICO
Ref.^a B017**



Ref.^a B017



Normas:

EN352-1:2002 CE

ANSI S3.19

SNR: 29 dB



CARATERÍSTICAS:

- Perfil rebaixado para ser compatível com equipamento protetor da cabeça;
- Desdobrável para fácil armazenamento;
- Banda acolchoada para maior conforto;
- Tamanho universal;
- Leve, indicado para uso de longa duração;
- Material: ABS e Poliacetal.

Desempenho conforme Diretiva Europeia n.º
89/686/CEE
relativa aos Equipamentos de Proteção
Individual;

	PREÇO
1 Unidade	8,00

**PROTETOR AURICULAR
PARA MONTAR EM CAPACETE
Ref.^a B011**



Ref.^a B011



Normas:

EN352-3:2002 CE

ANSI S3.19

SNR: 24 dB



CARATERÍSTICAS:

- Fácil de aplicar, sem necessidade de usar ferramentas;
- Ajustável em três posições: descanso, uso e armazenamento;
- Zona das orelhas almofadada;
- Leve, indicado para uso de longa duração;
- Material: ABS e Poliacetal.

Desempenho conforme Diretiva Europeia n.º
89/686/CEE
relativa aos Equipamentos de Proteção
Individual;

	PREÇO
1 Unidade	6,50

**CONJUNTO DE PROTEÇÃO COMBINADA
AURICULAR + ÓCULOS + MÁSCARA
Ref.^a B003, B601, B701**



Ref.^a B003, B601, B701



Normas:

EN352-1, 166, 149
ANSI Z87+, S3.19
SNR: 25 dB

CARATERÍSTICAS:

- Óculos de proteção total ventilados (B601), sobreponíveis com todo o tipo de óculos;
- Lente dos óculos: policarbonato;
- Máscara descartável (B701) para uma respiração livre de pós, poeiras não tóxicas e pólenes;
- Material da máscara: polipropileno;
- Protetor auricular ajustável (B003);
- Material do auricular: ABS e Poliacetal.

Desempenho conforme Diretiva Europeia n.º 89/686/CEE relativa aos Equipamentos de Proteção Individual;

	PREÇO
1 Unidade	6,20

**CONJUNTO DE PROTEÇÃO COMBINADA
VISEIRA EM MALHA DE AÇO + AURICULAR
Ref.^a B916, B020**



Ref.^a B916, B020



Normas:

EN166, 1731, 352-1
ANSI Z87+
SNR: 27 dB

Acessório extra

CARATERÍSTICAS:

- Conjunto de proteção combinada com viseira em malha de aço (B916) e auricular (B020);
- Aplicação ou substituição fácil do visor, sem necessidade de ferramenta;
- Adequado à maioria das actividades de jardim;
- Material do auricular: ABS e Poliacetal;
- Acessório extra: visor em policarbonato.

Desempenho conforme Diretiva Europeia n.º 89/686/CEE relativa aos Equipamentos de Proteção Individual;

PRODUTO		PREÇO
CONJUNTO DE PROTEÇÃO	1 Unidade	14,50
ACESSÓRIO EXTRA (B922)	1 Unidade	4,00

PARKA DE ALTA VISIBILIDADE VWJK01



CARATERÍSTICAS:

Tipo: Parka

Cor: Amarelo

Tamanhos: Do S ao XXL

Material: 100% Poliéster recoberto com material 300D Oxford PU

Aperto: ZIP recoberto com aperto de molas

Fitas refletoras: 2 Horizontais | 2 Verticais

Notas:

- 100% poliéster com 180 g/metro quadrado de recobrimento interior de poliéster;
- Costuras ocultas, carcela recoberta e capuz oculto;
- 2 bolsos inferiores, 1 bolso para telemóvel e 1 bolso interior;
- Costuras ocultas com fecho ZIP recoberto;

Desempenho conforme Diretiva Europeia n.º 89/686/CEE relativa aos Equipamentos de Proteção Individual;

Normas:

EN471 classe 3/2;

EN343 classe 3/1;



	TAMANHOS					PREÇO
	S	M	L	XL	XXL	
10 Unidades						55,00

BLUSÃO DE ALTA VISIBILIDADE VWJK04



CARATERÍSTICAS:

Tipo: Blusão

Cor: Amarelo

Tamanhos: Do S ao XXL

Material: 100% Poliéster recoberto com material 300D Oxford PU

Aperto: ZIP recoberto com aperto de molas

Fitas refletoras: 2 Horizontais | 2 Verticais

Notas:

- 100% Poliéster com 180 g/metro quadrado de recobrimento interno de poliéster;
- Costuras ocultas, carcela recoberta e capuz oculto;
- Dois bolsos inferiores e um bolso para telemóvel;
- Elástico nas costas e nas mangas;

Desempenho conforme Diretiva Europeia n.º 89/686/CEE relativa aos Equipamentos de Proteção Individual;

Normas:

EN471 classe 3;

EN343 classe 3/1;



	TAMANHOS					PREÇO
	S	M	L	XL	XXL	
10 Unidades						50,00

**CONJUNTO IMPERMEÁVEL
DE ALTA VISIBILIDADE
VWJK67 + VWJK68**



CARATERÍSTICAS:

Tipo: Conjunto impermeável (blusão + calças)

Cor: Amarelo

Tamanhos: Do S ao XXL

Material: 100% Poliéster recoberto com material 150D Oxford PU

Aperto: ZIP recoberto com aperto de molas + Elástico

Fitas refletoras: 2 Horizontais

Notas: VWJK67:

- Blusão à prova de água;
- Costuras completamente recobertas;
- 2 bolsos externos.

VWJK68:

- Calças sem forro;
- Costuras ocultas;
- Elástico na cinta.



Fornecido embalado em saco de alta visibilidade com fecho de ZIP.

Desempenho conforme Diretiva Europeia n.º 89/686/CEE relativa aos Equipamentos de Proteção Individual;

Normas:

EN471 classe 3;

EN343 classe 3/1;



	TAMANHOS					PREÇO
	S	M	L	XL	XXL	
10 Unidades						55,00

COLETE DE ALTA VISIBILIDADE VWEN01



CARACTERÍSTICAS:

Tipo: Colete

Cor: Amarelo

Tamanhos: Tamanho único

Material: 100% Poliéster

Aperto: Velcro

Fitas refletoras: 2 Horizontais

Notas:

Desempenho conforme Diretiva Europeia n.º 89/686/CEE
relativa aos Equipamentos de Proteção Individual;

Normas:

EN471 classe 2;

EN ISO 20471



	TAMANHOS	PREÇO
 50 Unidades	Tamanho único	2,50

T-SHIRT DE ALTA VISIBILIDADE VWTS01-B



CARACTERÍSTICAS:

Tipo: T-Shirt

Cor: Amarelo

Tamanhos: Do S ao XXL

Material: 100% Poliéster

Aperto: -

Fitas refletoras: 2 Horizontais

Notas:
- Tecido com acabamento que melhora a transpiração;
- 1 bolso superior.

Desempenho conforme Diretiva Europeia n.º 89/686/CEE
relativa aos Equipamentos de Proteção Individual;

Normas:

EN471 classe 2;

EN471



	TAMANHOS					PREÇO
 20 Unidades	S	M	L	XL	XXL	12,00

CALÇÕES DE TRABALHO MODELO RONA II



CALÇÃO DE TRABALHO MODELO: RONA II



Caraterísticas:

- 100% algodão;
- 3 bolsos laterais para ferramentas;
- Design moderno e confortável.

Cores disponíveis



Azul

Cinza

Preto

Areia

	Quantidade/tamanho					TOTAL
	S	M	L	XL	XXL	
	2	4	5	4	3	18 Unidades

TAMANHOS					PREÇO €/Unid.
S	M	L	XL	XXL	10,00

**TENSORES DE ALAMBRE
ZINCADOS - PINTADOS
ESTICADORES DE RAMADA (ZINCADOS / PINTADOS)**



**TENSORES DE ALAMBRE - ZINCADOS / PINTADOS
ESTICADORES DE RAMADA - ZINCADOS / PINTADOS**

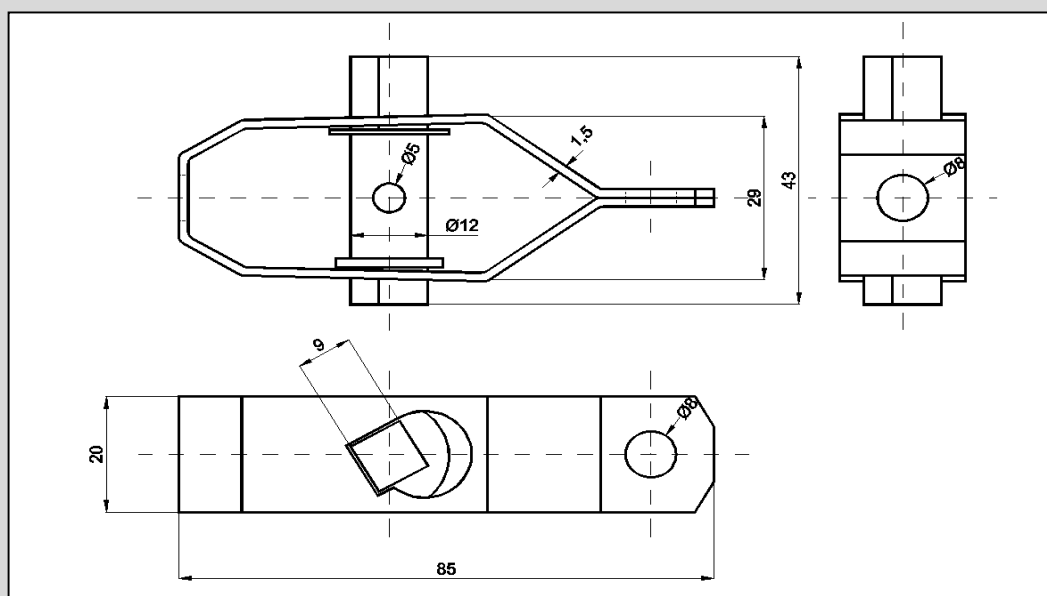

- Construídos em chapa de aço com 1,5 mm de espessura;
- Quadra de 9 mm;
- Zincagem electrolítica A2K com $5 \mu\text{m}$ de espessura;
- Zonas de dobragem reforçadas com nervuras.

DESIGNAÇÃO		PREÇO / 100
Esticadores de ramada - zincados	300	42,00
Esticadores de ramada - verdes	300	44,00